

CRBIM1002—2015

# Railway BIM Data Standard

(Version 1.0)

Issued on: 2015-12-29

Implemented on: 2016-01-01

---

China Railway BIM Alliance

## Foreword

In order to share information in different application platforms, different participants and different engineering stages, and to deliver open-format based BIM outcomes to the owners and industry regulators, this standard is developed. This standard is an extension of IFC4x1 in railway engineering domain.

This standard covers the following disciplines in railway engineering: alignment, track, subgrade, bridge, tunnel, station, drainage and geology.

The China Railway BIM Alliance is responsible for the interpretation of this standard. Any feedback of modification and supplement requirements is welcomed by the China Railway BIM Alliance.

### **Editors in chief:**

- The Third Railway Survey and Design Institute Group Corporation (The 3<sup>rd</sup> Design Institute): Sun Shuli, Li Hualiang, Yang Xukun, Yao Fengfeng, Su Lin, Mao Ning, Ai Shanding, Feng Pei, Feng Shanqun, Yan Dongxu, Fan Dengke, Han Zujie, Qi Chunyu, Zhao Feifei, Zhang Chen, Wei Yinghong, Zhu Tianhua, Zhu Qingqing, Yu Xingliang, Sun Haifu, Li Ronghua, Kong Guoliang, Wang KaiJun, Li Zhiji, Chang Cheng, Wu Weifan, Su Wei, Song Shufeng, Qi Chenglong, Miao Yongkang, Wang Shiqing, Meng Qingyu, Guo Jianyong, Ma Yongchang, Wang Hao, Liu Zhongjie, Chen Zelian
- Tsinghua University: Gu Ming, Liu Yushen, Gao Ge, Zhu Mingjuan, Wu Jiaying, Lin Pengpeng, Wu Pengfei

### **Editors:**

- China Railway Engineering Management Center: Li Zhiyi, Sheng Liming, Shen Dongsheng, Liu Yanhong, Wang Wanqi, Chen Liang, Chen Yun, Wang Jiang, Suo Ning, Li Hui
- China Railway First Survey & Design Institute Group CO., LTD. (The 1<sup>st</sup> Design Institute): Wen Zhouquan, Li Zhibiao, Wang Wei, Ni Wei, Meng Cunxi, Liu Xingang, Wei Fanghua, Wang Peng, Zhang YanSheng, Yu Peng, Zhou Fujun, Zheng Liangliang, Xu Xingwang, Jin Meng, Liu Yanming, Sha Peizhou, Xu Bo, Cheng Fanghui, Zhou Haibo, Liu Lei, Zhu Tieshuan, Yu Feng, Yang Changhui, Wang Zhaocun, Yan Peng, Wu Wenbin, Luo Wen, Yang Yuxiu
- China Railway Eryuan Engineering Group CO.LTD. (The 2<sup>nd</sup> Design Institute): Zhang Xuecai, Zhou Jian, Dong Fengxiang, Zhang Yi, Liu Houqiang, Li Junsong, Ye Mingzhu, Yang Yongyi, Shao Yan, Chen Gang, Zhu Yongbiao, Wang Yanzhe, Xu Jun, Zheng Yi, Wu Hualin, Li Liangwei, Liu Dayuan, Zhao Liangliang, Yi Fengfeng, Jin Yongle, Lin Shaoping, Wang Yiping, Hu Guangchang, Mao Ling, Wang Yimin, Zhang Yao
- China Railway SIYUAN Survey & Design Group Co., Ltd. (The 4<sup>th</sup> Design Institute): Xu Yonghong, Cao Feng, Peng Xianbao, Han Yuanli, Han Song, Ma Huan, Quan Shunxi, Fu Jie, Yu Xingsheng, Zhang Jian, Zhao Yueyue, Dai Linfabao, Li Pei, Zhang Xiechong, Xie Hao, Jiang Daojun, Shi Bibo
- China Academy of Railway Sciences: Wang Tongjun, Zhao Youming, Ye Yangsheng, Luo Qingzhog, Shi Weifeng, Yu Xin, Wang Weidong, Shi Tianyun, Zhang Weijiao, Lu Wenlong, Cai Degou, Xie Yalong, Zhang Jinchao, Guo Ge, Niu Hongrui, Wang Chao,

Liang Ce, Hao Rui, Wang Tong, Wang Huilin, Shen Haiyan, Feng Yunmei, Zhao Xinxin,  
Pan Yongjie, Bai Ping

- China Tiesiju Civil Engineering Group Co., Ltd.: Wu Jun, Wang Qinghe, Wang Guoming,  
Hu Lei, Wang Buyun
- China Construction Communications Engrg. Group Corp. LTD: Wang Yongyi, Liu Wei,  
Wen Guowei, Ma Chunquan, Xie Zhongyuan, Sun Xiliang

## Contents

<b>Railway BIM Data Standard (Version 1.0)</b> .....	1
<b>1. Introduction</b> .....	1
<b>1.1 Principle</b> .....	1
<b>1.2 Scope</b> .....	1
<b>1.3 Purpose</b> .....	1
<b>1.4 Normative References</b> .....	1
<b>2. Terms, definitions and abbreviations</b> .....	2
<b>2.1 Terms and definitions</b> .....	2
<b>2.2 Abbreviations</b> .....	2
<b>3. Framework</b> .....	2
<b>3.1 Architecture</b> .....	3
<b>3.2 Railway Engineering Spatial Composition</b> .....	3
<b>4. Shared Railway Element Schemas</b> .....	4
<b>4.1 Shared Types</b> .....	4
<b>4.1.1 IfcGeoElementComponentTypeEnum</b> .....	4
<b>4.2 Shared Spatial Structure Elements</b> .....	5
<b>4.2.1 IfcCivilStructureElement</b> .....	5
<b>4.2.2 IfcRailwayStructureElement</b> .....	6
<b>4.2.3 IfcRailway</b> .....	6
<b>4.3 Shared Components</b> .....	7
<b>4.3.1 IfcCivilElementComponent</b> .....	7
<b>4.3.2 IfcRailwayElementComponent</b> .....	7
<b>4.3.3 IfcGeoElementComponent</b> .....	8
<b>4.4 Shared Property Sets</b> .....	8
<b>4.4.1 Pset_RailwayProject</b> .....	8
<b>4.4.2 Pset_MainTechnicalStandardOfRailway</b> .....	9
<b>4.4.3 Pset_ConcreteElementGeneral</b> .....	10
<b>4.4.4 Pset_PrecastConcreteElementFabrication</b> .....	11
<b>4.4.5 Pset_PrecastConcreteElementGeneral</b> .....	12
<b>4.4.6 Pset_GeologicalCondition</b> .....	14
<b>4.4.7 Pset_StandardDrawingNumber</b> .....	15
<b>4.4.8 Pset_RailwayElementCommon</b> .....	15
<b>4.4.9 Pset_ANCHOREDBOLT</b> .....	16
<b>5. Alignment Schema</b> .....	16
<b>5.1 Schema Definition</b> .....	16
<b>5.2 Type Definition</b> .....	19
<b>5.2.1 IfcAlignmentTypeEnum</b> .....	19
<b>5.2.2 IfcTransitionCurveTypeEnum</b> .....	19
<b>5.3 Entity Definition</b> .....	20
<b>5.3.1 IfcAlignment</b> .....	20
<b>5.3.1.1 Entity definition</b> .....	20
<b>5.3.1.2 Attribute definitions</b> .....	20
<b>5.3.1.3 EXPRESS specification</b> .....	20

5.3.2 IfcAlignment2DHorizontal.....	21
5.3.2.1 Entity definition.....	21
5.3.2.2 Attribute definitions.....	21
5.3.2.3 EXPRESS specification.....	22
5.3.3 IfcAlignment2DVertical.....	22
5.3.3.1 Entity definition.....	22
5.3.3.2 Attribute definitions.....	22
5.3.3.3 EXPRESS specification.....	22
5.3.4 IfcAlignment2DSegment.....	22
5.3.4.1 Entity definition.....	22
5.3.4.2 Attribute definitions.....	23
5.3.4.3 EXPRESS specification.....	23
5.3.5 IfcAlignment2DHorizontalSegment.....	23
5.3.5.1 Entity definition.....	23
5.3.5.2 Attribute definitions.....	23
5.3.5.3 EXPRESS specification.....	24
5.3.6 IfcAlignment2DVerticalSegment.....	24
5.3.6.1 Entity definition.....	24
5.3.6.2 Attribute definitions.....	24
5.3.6.3 EXPRESS specification.....	24
5.3.7 IfcCurveSegment2D.....	25
5.3.7.1 Entity definition.....	25
5.3.7.2 Attribute definitions.....	25
5.3.7.3 EXPRESS specification.....	25
5.3.8 IfcLineSegment2D.....	25
5.3.8.1 Entity definition.....	25
5.3.8.2 Attribute definitions.....	25
5.3.8.3 EXPRESS specification.....	25
5.3.9 IfcCircularArcSegment2D.....	26
5.3.9.1 Entity definition.....	26
5.3.9.2 Attribute definitions.....	26
5.3.9.3 EXPRESS specification.....	26
5.3.10 IfcTransitionCurve2D.....	26
5.3.10.1 Entity definition.....	26
5.3.10.2 Attribute definitions.....	26
5.3.10.3 EXPRESS specification.....	27
5.3.11 IfcAlignment2DVerSegLine.....	27
5.3.11.1 Entity definition.....	27
5.3.11.2 Attribute definitions.....	27
5.3.11.3 EXPRESS specification.....	27
5.3.12 IfcAlignment2DVerSegCircularArc.....	27
5.3.12.1 Entity definition.....	27
5.3.12.2 Attribute definitions.....	27
5.3.12.3 EXPRESS specification.....	27

5.3.13	<b>IfcAlignment2DVerSegParabolicArc</b> .....	28
5.3.13.1	Entity definition.....	28
5.3.13.2	Attribute definitions.....	28
5.3.13.3	EXPRESS specification.....	28
5.3.14	<b>IfcChainageSystem</b> .....	28
5.3.14.1	Entity definition.....	29
5.3.14.2	Attribute definitions.....	29
5.3.14.3	EXPRESS specification.....	29
5.3.15	<b>IfcChainageSystemSegment</b> .....	29
5.3.15.1	Entity definition.....	29
5.3.15.2	Attribute definitions.....	30
5.3.15.3	EXPRESS specification.....	30
5.4	<b>Property Set Definition</b> .....	31
5.4.1	<b>Pset_Alignment</b> .....	31
6.	<b>Terrain Schema</b> .....	31
7.	<b>Geology Schema</b> .....	31
7.1	<b>Schema Definition</b> .....	31
7.1.1	<b>Spatial Structure Elements of Geology</b> .....	32
7.1.2	<b>Physical Elements of Geology</b> .....	32
7.2	<b>Type Definition</b> .....	33
7.2.1	<b>IfcGeologyPartTypeEnum</b> .....	33
7.2.2	<b>IfcGeologyTypeEnum</b> .....	34
7.2.3	<b>IfcSpecialGeologyTypeEnum</b> .....	34
7.2.4	<b>IfcGeologyDisasterTypeEnum</b> .....	35
7.3	<b>Entity Definition</b> .....	36
7.3.1	<b>IfcGeologyPart</b> .....	36
7.3.2	<b>IfcGeologyElement</b> .....	36
7.3.3	<b>IfcRockSoilMass</b> .....	36
7.3.4	<b>IfcDrillHole</b> .....	37
7.3.5	<b>IfcDrillHoleLayer</b> .....	37
7.4	<b>Property Set Definition</b> .....	38
7.4.1	<b>Pset_GeologyPart</b> .....	38
7.4.2	<b>Pset_RockSoilMassCommon</b> .....	38
7.4.3	<b>Pset_DrillHole</b> .....	39
7.4.4	<b>Pset_RockSoilMassProperty</b> .....	39
7.4.5	<b>Pset_SpecialGeology_COLLAPSIBLESOIL</b> .....	39
7.4.6	<b>Pset_SpecialGeology_EXPANSIVESOIL</b> .....	40
7.4.7	<b>Pset_SpecialGeology_FROST</b> .....	40
7.4.8	<b>Pset_SpecialGeology_HALOMORPHICSOIL</b> .....	40
7.4.9	<b>Pset_SpecialGeology_POLLUTIONSOIL</b> .....	41
7.4.10	<b>Pset_GeologyDisaster_LANDSLIDE</b> .....	41
7.4.11	<b>Pset_GeologyDisaster_DEBRISFLOW</b> .....	41
7.4.12	<b>Pset_GeologyDisaster_KARST</b> .....	41
7.4.13	<b>Pset_GeologyDisaster_GOB</b> .....	41

7.4.14 Pset_GeologyDisaster_RADIOACTIVE .....	42
7.4.15 Pset_GeologyDisaster_SANDSTORM .....	42
7.4.16 Pset_TestParameter.....	42
<b>8. Subgrade Schema.....</b>	<b>43</b>
<b>8.1 Schema Definition .....</b>	<b>43</b>
8.1.1 Spatial Structure Elements of Subgrade .....	45
8.1.2 Physical Elements of Subgrade .....	47
8.1.3 Element Assemblies of Subgrade .....	48
<b>8.2 Type Definition .....</b>	<b>49</b>
8.2.1 IfcSubgradeStructureTypeEnum.....	49
8.2.2 IfcSubgradeFunctionTypeEnum.....	49
8.2.3 IfcSubgradeStructurePartTypeEnum .....	49
8.2.4 IfcSubgradeSlopeProtectionTypeEnum .....	50
8.2.5 IfcSubgradeRetainingStructureTypeEnum .....	50
8.2.6 IfcSubgradeSubsoilTreatmentTypeEnum .....	51
8.2.7 IfcSubgradeTransitionSectionStructureTypeEnum.....	52
8.2.8 IfcSubgradeRetainingElementTypeEnum .....	52
8.2.9 IfcSubgradeFillingWorksTypeEnum.....	53
8.2.10 IfcSubgradeSlopeProtectionSectionElementTypeEnum.....	54
8.2.11 IfcSubgradeSubsoilReinforcementPileElementTypeEnum .....	55
8.2.12 IfcSubgradeOriginalSubgradeSubsoilReinforcementTypeEnum.....	55
8.2.13 IfcSubgradeTransitionSectionElementTypeEnum .....	56
8.2.14 IfcSubgradeRetainingStructureSectionAssemblyTypeEnum .....	56
8.2.15 IfcSubgradeSubsoilReinforcementPileAssemblyTypeEnum.....	57
<b>8.3 Entity Definition .....</b>	<b>58</b>
8.3.1 IfcSubgradeStructureElement .....	58
8.3.2 IfcSubgrade.....	58
8.3.3 IfcSubgradeStructurePartElement.....	59
8.3.4 IfcSubgradeSlopeProtectionElement.....	60
8.3.5 IfcSubgradeRetainingStructureElement.....	60
8.3.6 IfcSubgradeSubsoilTreatmentElement .....	62
8.3.7 IfcSubgradeTransitionSectionStructureElement .....	63
8.3.8 IfcSubgradeElement .....	63
8.3.9 IfcSubgradeRetainingElement .....	63
8.3.10 IfcSubgradeFillingWorks .....	64
8.3.11 IfcSubgradeSlopeProtectionSectionElement .....	65
8.3.12 IfcSubgradeSubsoilReinforcementPileElement.....	65
8.3.13 IfcOriginalSubgradeSubsoilReinforcement.....	66
8.3.14 IfcSubgradeTransitionSectionElement.....	66
8.3.15 IfcSubgradeElementAssembly .....	67
8.3.16 IfcSubgradeRetainingStructureSectionAssembly .....	67
8.3.17 IfcSubgradeSubsoilReinforcementPileAssembly .....	68
<b>8.4 Property Set Definition .....</b>	<b>68</b>
8.4.1 Pset_SubgradeStructurePartElementCommon.....	68

8.4.2 Pset_SubgradeSlopeProtectionElementCommon .....	69
8.4.3 Pset_SubgradeRetainingStructureElementCommon.....	69
8.4.4 Pset_SubgradeSubsoilTreatmentElementCommon .....	69
8.4.5 Pset_REICONRETWALL.....	70
8.4.6 Pset_ANCBOLTRETWALL .....	70
8.4.7 Pset_EMBANKMENTCUTTING .....	70
8.4.8 Pset_SubgradeFillingWorksCommon .....	71
8.4.9 Pset_SubgradeSlopeProtectionSectionElementCommon .....	71
8.4.10 Pset_SubgradeSubsoilReinforcementPileElementCommon .....	71
8.4.11 Pset_OriginalSubgradeSubsoilReinforcementCommon .....	72
8.4.12 Pset_GRARETBODY .....	72
8.4.13 Pset_BALWEIRETBODY .....	72
8.4.14 Pset_CANRETBODY .....	73
8.4.15 Pset_COURETBODY .....	73
8.4.16 Pset_ANCHORAGEPILE .....	73
8.4.17 Pset_RETAININGPLATE.....	73
8.4.18 Pset_RIBBEDCOLUMN .....	74
8.4.19 Pset_PANEL .....	74
8.4.20 Pset_REIEARRETBODY .....	74
8.4.21 Pset_PRECABLEBODY .....	75
8.4.22 Pset_REPSUBBASE .....	75
8.4.23 Pset_PILECAP .....	75
8.4.24 Pset_PILEBODY.....	75
8.4.25 Pset_COMPACTION.....	76
8.4.26 Pset_RAMMED.....	76
8.4.27 Pset_GROUTING .....	76
8.4.28 Pset_TRANSITIONCONE.....	77
8.4.29 Pset_FOUNDATIONBACKFILLINGSOIL.....	77
8.4.30 Pset_NONSANDCONPERPLATE .....	77
8.4.31 Pset_REPLACEMENTSOIL .....	77
<b>9. Bridge Schema.....</b>	<b>78</b>
<b>9.1 Schema Definition .....</b>	<b>78</b>
<b>9.1.1 Spatial Structure Elements of Bridge.....</b>	<b>80</b>
<b>9.1.2 Physical Elements of Bridge.....</b>	<b>81</b>
<b>9.1.3 Element Assemblies of Bridge .....</b>	<b>84</b>
<b>9.1.4 Others.....</b>	<b>85</b>
<b>9.2 Type Definition .....</b>	<b>86</b>
<b>9.2.1 IfcBridgeStructureTypeEnum.....</b>	<b>86</b>
<b>9.2.2 IfcBridgeStructurePartTypeEnum .....</b>	<b>86</b>
<b>9.2.3 IfcBridgeMemberTypeEnum .....</b>	<b>87</b>
<b>9.2.4 IfcBridgeStiffeningRibTypeEnum .....</b>	<b>87</b>
<b>9.2.5 IfcBridgeSlabTypeEnum .....</b>	<b>88</b>
<b>9.2.6 IfcBridgeGirderSegmentTypeEnum.....</b>	<b>88</b>
<b>9.2.7 IfcBridgeGearBlockTypeEnum .....</b>	<b>88</b>



9.2.8 IfcBridgeBedStoneTypeEnum.....	89
9.2.9 IfcBridgePierSegmentTypeEnum .....	89
9.2.10 IfcBridgeAbutmentSegmentTypeEnum .....	89
9.2.11 IfcBridgePylonSegmentTypeEnum.....	90
9.2.12 IfcBridgeArchSegmentTypeEnum.....	90
9.2.13 IfcBridgeArchfootTypeEnum.....	91
9.2.14 IfcBridgeStandColumnTypeEnum .....	91
9.2.15 IfcBridgeSuspenderTypeEnum.....	91
9.2.16 IfcBridgeCableTypeEnum.....	91
9.2.17 IfcBridgeSuspendedTendonTypeEnum.....	92
9.2.18 IfcBridgeBearingTypeEnum .....	92
9.2.19 IfcBridgeExpansionInstallationTypeEnum .....	92
9.2.20 IfcBridgeProtectingWallTypeEnum .....	93
9.2.21 IfcBridgeFrameSegmentTypeEnum.....	93
9.2.22 IfcBridgeWingWallTypeEnum.....	93
9.2.23 IfcBridgeCulvertSegmentTypeEnum .....	94
9.2.24 IfcBridgeHatStoneTypeEnum.....	94
9.2.25 IfcBridgeCopingTypeEnum .....	94
9.2.26 IfcBridgeEmbeddedPartsFoundationTypeEnum.....	94
9.2.27 IfcBridgeRefugePlatformTypeEnum.....	95
9.2.28 IfcBridgeTrussTypeEnum .....	95
9.2.29 IfcBridgeJointTypeEnum .....	95
9.2.30 IfcBeamFallingPreventionDeviceTypeEnum.....	96
9.2.31 IfcCrossBraceTypeEnum.....	96
<b>9.3 Entity Definition .....</b>	<b>97</b>
9.3.1 IfcBridgeStructureElement .....	97
9.3.2 IfcBridge .....	97
9.3.3 IfcBridgePart.....	101
9.3.4 IfcBridgeElement .....	103
9.3.5 IfcBridgeMember .....	103
9.3.6 IfcBridgeStiffeningRib.....	104
9.3.7 IfcBridgeSlab .....	104
9.3.8 IfcBridgeGirderSegment .....	105
9.3.9 IfcBridgeGearBlock .....	105
9.3.10 IfcBridgeBedstone .....	106
9.3.11 IfcBridgePierSegment .....	106
9.3.12 IfcBridgeAbutmentSegment.....	106
9.3.13 IfcBridgePylonSegment .....	107
9.3.14 IfcBridgeArchSegment .....	107
9.3.15 IfcBridgeArchFoot .....	107
9.3.16 IfcBridgeStandColumn .....	108
9.3.17 IfcBridgeSuspender.....	108
9.3.18 IfcBridgeCable.....	109
9.3.19 IfcBridgeSuspendedTendon .....	109

9.3.20	IfcBridgeBearing .....	109
9.3.21	IfcBridgeExpansionInstallation .....	110
9.3.22	IfcBridgeProtectingWall .....	110
9.3.23	IfcFrameSegment .....	111
9.3.24	IfcBridgeWingWall .....	111
9.3.25	IfcBridgeCulvertSegment .....	111
9.3.26	IfcBridgeHatStone .....	112
9.3.27	IfcBridgeCoping .....	112
9.3.28	IfcBridgeEmbeddedPartsFoundation .....	112
9.3.29	IfcBridgeRefugePlatform .....	113
9.3.30	IfcBridgeElementAssembly .....	113
9.3.31	IfcBridgeTruss .....	113
9.3.32	IfcBridgeJoint .....	114
9.3.33	IfcBeamFallingPreventionDevice .....	115
9.3.34	IfcCrossBrace .....	115
9.4	Property Set Definition .....	116
9.4.1	Pset_BridgeCommon .....	116
9.4.2	Pset_TechnicalStandard .....	116
9.4.3	Pset_TechnicalIndex .....	117
9.4.4	Pset_Bellow .....	118
9.4.5	Pset_BridgeCable .....	118
9.4.6	Pset_ArchBridge .....	118
9.4.7	Pset_RigidBridge .....	119
9.4.8	Pset_Gird .....	119
9.4.9	Pset_BridgePier .....	120
9.4.10	Pset_PileCommon .....	120
9.4.11	Pset_Abutment .....	120
9.4.12	Pset_Culvert .....	120
9.4.13	Pset_BridgeBearing .....	121
9.4.14	Pset_BridgeExpansionInstallation .....	121
10.	Tunnel Schema .....	122
10.1	Schema Definition .....	122
10.1.1	Spatial Structure Elements of Tunnel .....	123
10.1.2	Physical Elements of Tunnel .....	124
10.2	Type Definition .....	126
10.2.1	IfcTunnelTypeEnum .....	126
10.2.2	IfcTunnelFunctionTypeEnum .....	127
10.2.3	IfcTunnelPartTypeEnum .....	128
10.2.4	IfcAdvanceSupportTypeEnum .....	128
10.2.5	IfcPrimarySupportTypeEnum .....	129
10.2.6	IfcSystemAncherBoltTypeEnum .....	129
10.2.7	IfcSystemSteelFrameTypeEnum .....	129
10.2.8	IfcInitialSupportShotcreteTypeEnum .....	129
10.2.9	IfcTunnelLiningTypeEnum .....	130

10.2.10	IfcPortalStructureTypeEnum .....	130
10.2.11	IfcInvertFillingTypeEnum .....	131
10.2.12	IfcWaterproofLayerTypeEnum .....	131
10.2.13	IfcLevelingBlanketTypeEnum .....	131
10.2.14	IfcProtectiveLayerTypeEnum .....	132
10.2.15	IfcProtectiveArchTypeEnum.....	132
10.2.16	IfcTemporarySupportTypeEnum .....	132
10.3	Entity Definition .....	133
10.3.1	IfcTunnelStructureElement.....	133
10.3.2	IfcTunnel .....	133
10.3.3	IfcTunnelPart.....	134
10.3.4	IfcTunnelElement .....	135
10.3.5	IfcTunnelAdvanceSupport .....	136
10.3.6	IfcTunnelPrimarySupport.....	136
10.3.7	IfcSystemAncherBolt .....	137
10.3.8	IfcSystemSteelFrame .....	137
10.3.9	IfcInitialSupportShotcrete.....	138
10.3.10	IfcTunnelLiningStructure.....	138
10.3.11	IfcTunnelPortalStructure.....	139
10.3.12	IfcTunnelInvertFilling.....	140
10.3.13	IfcWaterproofLayer .....	140
10.3.14	IfcLevelingBlanket .....	141
10.3.15	IfcProtectiveLayer.....	141
10.3.16	IfcTemporarySupport .....	142
10.3.17	IfcProtectiveArch .....	142
10.4	Property Set Definition .....	143
10.4.1	Pset_TunnelCommon .....	143
10.4.2	Pset_PortalCommon .....	143
10.4.3	Pset_Open-cutTunnelCommon .....	144
10.4.4	Pset_Under-cutTunnelCommon.....	144
10.4.5	Pset_TunnelChamberCommon.....	144
10.4.6	Pset_ShedTunnelCommon.....	145
10.4.7	Pset_TunnelAdvanceSupportCommon .....	145
10.4.8	Pset_TunnelPrimarySupportCommon .....	146
10.4.9	Pset_SystemAncherBoltCommon .....	146
10.4.10	Pset_SystemSteelArchCommon .....	147
10.4.11	Pset_InitialSupportShotcreteCommon.....	147
10.4.12	Pset_TunnelLiningCommon.....	147
10.4.13	Pset_WaterproofLayerCommon .....	148
10.4.14	Pset_LevelingBlanketCommon .....	148
10.4.15	Pset_ProtectiveLayerCommon.....	148
11.	Drainage Schema.....	149
11.1	Schema Definition.....	149
11.2	Distribution System Definition.....	149

11.3	Drainage Segment Definition.....	150
11.4	Chamber Facility .....	151
12.	Track Schema .....	151
12.1	Schema Definition .....	151
12.1.1	Spatial Structure Elements of Track .....	152
12.1.2	Physical Elements of Track .....	153
12.1.3	Element Assemblies of Track.....	156
12.1.4	Element Components of Track.....	156
12.1.5	Other Element Components .....	157
12.2	Type Definition .....	158
12.2.1	IfcTrackTypeEnum .....	158
12.2.2	IfcTrackRouteDirectionTypeEnum .....	159
12.2.3	IfcTrackRouteFunctionTypeEnum.....	159
12.2.4	IfcTrackPartStructureTypeEnum .....	160
12.2.5	IfcTrackPartFunctionTypeEnum .....	160
12.2.6	IfcTrackRailTypeEnum .....	161
12.2.7	IfcTrackFasteningElasticityTypeEnum.....	161
12.2.8	IfcTrackFasteningStructureTypeEnum .....	161
12.2.9	IfcTrackSleeperTypeEnum.....	162
12.2.10	IfcTrackSlabTypeEnum.....	163
12.2.11	IfcTrackConcreteSlabTypeEnum.....	163
12.2.12	IfcTrackIsolationLayerTypeEnum .....	163
12.2.13	IfcTrackElasticCushionTypeEnum.....	164
12.2.14	IfcTrackAdjustmentlayerTypeEnum .....	164
12.2.15	IfcTrackBaseTypeEnum .....	164
12.2.16	IfcTrackTurnoutTypeEnum .....	165
12.2.17	IfcTrackBallastLayerTypeEnum .....	165
12.2.18	IfcTrackExpansionJointTypeEnum.....	166
12.2.19	IfcBallastBedTypeEnum.....	166
12.2.20	IfcTrackPanelTypeEnum.....	166
12.2.21	IfcTrackRailJointTypeEnum.....	167
12.2.22	IfcTrackStrengtheningEquipmentTypeEnum .....	167
12.2.23	IfcTrackAccessoryEquipmentTypeEnum .....	168
12.2.24	IfcEarthingTerminalTypeEnum .....	168
12.3	Entity Definition .....	169
12.3.1	IfcTrack.....	169
12.3.2	IfcTrackPart .....	170
12.3.3	IfcTrackElement.....	171
12.3.4	IfcTrackRail .....	171
12.3.5	IfcTrackFastening .....	172
12.3.6	IfcTrackSleeper .....	172
12.3.7	IfcTrackSlab .....	173
12.3.8	IfcTrackConcreteSlab .....	174
12.3.9	IfcTrackIsolationLayer .....	174

12.3.10	IfcTrackElasticCushion .....	175
12.3.11	IfcTrackAdjustmentLayer .....	175
12.3.12	IfcTrackBase .....	176
12.3.13	IfcTrackTurnout .....	176
12.3.14	IfcTrackBallastLayer .....	177
12.3.15	IfcTrackExpansionJoint .....	177
12.3.16	IfcRailwayAssembly .....	178
12.3.17	IfcBallastBed .....	178
12.3.18	IfcTrackPanel .....	178
12.3.19	IfcTrackElementComponent .....	179
12.3.20	IfcTrackRailJoint .....	179
12.3.21	IfcTrackStrengtheningEquipment .....	180
12.3.22	IfcTrackAccessoryEquipment .....	180
12.3.23	IfcEarthingTerminal .....	181
12.4	Property Set Definition .....	181
12.4.1	Pset_TrackCommon .....	181
12.4.2	Pset_TrackPartCommon .....	182
12.4.3	Pset_RailCommon .....	183
12.4.4	Pset_TrackFasteningCommon .....	184
12.4.5	Pset_TrackSleeperCommon .....	185
12.4.6	Pset_TrackSlabCommon .....	185
12.4.7	Pset_TrackIsolationLayerCommon .....	186
12.4.8	Pset_TrackElasticCushionCommon .....	186
12.4.9	Pset_TrackAdjustmentlayerCommon .....	187
12.4.10	Pset_TrackBaseCommon .....	187
12.4.11	Pset_TrackBallastLayerCommon .....	188
12.4.12	Pset_TrackExpansionJointCommon .....	188
12.4.13	Pset_TrackPanelCommon .....	189
12.4.14	Pset_TurnoutCommon .....	189
12.4.15	Pset_RailJointFasteningCommon .....	191
12.4.16	Pset_RailCompromisingJointCommon .....	191
12.4.17	Pset_RailInsulatedJointCommon .....	191
12.4.18	Pset_RailWeldedJointCommon .....	192
12.4.19	Pset_RailConductiveJointCommon .....	192
12.4.20	Pset_RailUnchangeableJointCommon .....	193
12.4.21	Pset_TrackStrengtheningEquipmentCommon .....	193
12.4.22	Pset_TrackAccessoryEquipmentCommon .....	194
12.4.23	Pset_EarthingTerminalCommon .....	194
13.	Station Schema .....	194
13.1	Schema Definition .....	194
13.1.1	Spatial Structure Elements of Station .....	195
13.1.2	Physical Elements in Station Schema .....	196
13.2	Type Definition .....	197
13.2.1	IfcRailwayTerminalTypeEnum .....	197

13.2.2 IfcRailwayTerminalFeatureTypeEnum.....	198
13.2.3 IfcRailwayStationTypeEnum .....	199
13.2.4 IfcRailwayStationFeatureTypeEnum .....	199
13.2.5 IfcRailwayStationFormTypeEnum.....	200
13.2.6 IfcRailwayStationGradeTypeEnum .....	200
13.2.7 IfcRailwayPlatformTypeEnum .....	201
13.2.8 IfcRailwayPlatformPositionTypeEnum .....	201
13.2.9 IfcRailwaySignalTypeEnum.....	202
13.2.10 IfcRailwayClearancePostTypeEnum.....	203
13.2.11 IfcRailwaySpeedReducerTypeEnum .....	203
13.2.12 IfcRailwayRetarderTypeEnum.....	203
13.2.13 IfcRailwayDenoterTypeEnum.....	204
13.2.14 IfcRailwayCarBumperTypeEnum.....	205
13.2.15 IfcRailwayCarStopperTypeEnum .....	205
13.2.16 IfcRailwayCarStopperPositionTypeEnum.....	205
13.2.17 IfcRailwayPlatformWallTypeEnum .....	206
13.2.18 IfcRailwayFlatAisleTypeEnum .....	206
13.2.19 IfcRailwayWagonScaleTypeEnum.....	207
13.2.20 IfcRailwayDeflectionInstrumentTypeEnum .....	207
13.2.21 IfcRailwayIronShoeRemovingTypeEnum .....	207
13.2.22 IfcRailwayStopDeviceTypeEnum .....	208
13.2.23 IfcRailwayStopRetarderTypeEnum .....	208
13.2.24 IfcRailwayIronShoeTypeEnum.....	208
<b>13.3 Entity Definition .....</b>	<b>209</b>
13.3.1 IfcRailwayTerminal.....	209
13.3.2 IfcRailwayStation .....	209
13.3.3 IfcRailwayPlatform.....	210
13.3.4 IfcRailwaySignalDevice .....	211
13.3.5 IfcRailwaySignal .....	211
13.3.6 IfcRailwayClearancePost.....	211
13.3.7 IfcRailwaySpeedControlDevice .....	212
13.3.8 IfcRailwaySpeedReducer.....	212
13.3.9 IfcRailwayRetarder.....	212
13.3.10 IfcRailwayDenoterDevice .....	212
13.3.11 IfcRailwaySafetyDevice .....	213
13.3.12 IfcRailwayCarBumper.....	213
13.3.13 IfcRailwayCarStopper .....	213
13.3.14 IfcRailwayIronShoe .....	214
13.3.15 IfcRailwayStopRetarder.....	214
13.3.16 IfcRailwayStopDevice .....	214
13.3.17 IfcRailwayIronShoeRemoving .....	214
13.3.18 IfcRailwayPlatformWall.....	215
13.3.19 IfcRailwayFlatAisle.....	215
13.3.20 IfcRailwayMechanicalEquipment .....	215

13.3.21 IfcRailwayWagonScale .....	216
13.3.22 IfcRailwayTruckScale .....	216
13.3.23 IfcRailwayDeflectionInstrument.....	216
13.4 Property Set Definition .....	217
13.4.1 Pset_StationCommon.....	217
13.4.2 Pset_FlatAisleCommon.....	217
13.4.3 Pset_SignalCommon .....	217
14. Others.....	218
14. 1 Cable Slot.....	218

CPBBLM

# Railway BIM Data Standard

(Version 1.0)

## 1. Introduction

### 1.1 Principle

The development of the standard follows the following principles:

- 1) "Compatible principle". To achieve the highest compatibility with existing buildingSMART IFC (Industry Foundation Classes) standards and its ongoing extension work.
- 2) "Portable principle". The proposed standard only stipulates the basic data model of the railway domain. The elements in the model can be used in a variety of technical platforms with multiple coding ways.
- 3) "Abstract principle". To define the minimum entity set which are most widely understood and used.
- 4) "Extendable principle". The specific information about the railway engineering can be defined in various information classification standard of different country, regions respectively.
- 5) "Selectivity principle". Any element defined in this standard is optional to be used in information exchange and storage.
- 6) "Repeatable principle". Any element defined in this standard is repeatable to be used in data exchange and storage.
- 7) "Usability principle". The proposed standard is usable for both the human readability and machine readability to achieve the interoperability between software tools.

### 1.2 Scope

This standard currently covers the following disciplines in railway engineering: alignment, track, subgrade, bridge, tunnel, station, drainage and geology.

### 1.3 Purpose

This standard applies to the development of Railway BIM Implementation Standard, the development of Railway BIM software and related Railway BIM research.

### 1.4 Normative References

The following referenced documents are indispensable for the application of this document.

- 1) GB/T 16656.1-2008, Industrial automation systems and integration - Product data representation and exchange - Part 1: Overview and fundamental principles. (ISO 10303-1: 1994)
- 2) GB/T 16656.11-2010, Industrial automation systems and integration - Product data representation and exchange - Part 11: Description methods: The EXPRESS language reference manual. (ISO 10303-11: 2004)
- 3) GB/T 16656.21-2008, Industrial automation systems and integration - Product data



representation and exchange - Part 21: Implementation methods: Clear text encoding of the exchange structure. (ISO 10303-21: 2002)

4) GB/T 25507-2010, Industry foundation classes platform. (ISO 16739: 2013)

5) buildingSMART Industry Foundation Classes IFC4x1

6) buildingSMART Industry Foundation Classes IFC4x1 Alignment Extension

## 2. Terms, definitions and abbreviations

### 2.1 Terms and definitions

**Entity:** class of information defined by common attributes and constraints

**Attribute:** unit of information within an entity, defined by a particular type or reference to a particular entity

**Direct attribute:** unit of information directly describing entity characteristics

**Inverse attribute:** unit of information defining queries for obtaining related data and enforcing referential integrity

**Derived attribute:** unit of information computed from other values using an expression defined in this schema

**Property set:** unit of information containing a set of properties

**Schema:** the definition of the structure to organize data for storage, exchange and sharing, using a formal language

**Information model:** an abstract semantic representation of concepts and relationships in a certain domain

**Spatial structure element:** the generalization of all spatial elements that might be used to define a spatial structure

**Spatial composition:** the composition relationship between the part and the whole of the spatial structure elements

**Spatial decomposition:** the decomposition relationship between the whole and the parts of the spatial structure elements.

**Spatial containment:** the relationship of a spatial structure element containing the physical elements

**Contained in spatial structure:** the relationship of physical elements being contained within a spatial structure element.

**Entity composition:** an aggregation relationship where the element is part of another composite element

**EXPRESS-G:** a graphical modeling notation, used to identify classes, the data attributes of classes and the relationships that exist between classes

### 2.2 Abbreviations

AEC/FM Architecture, Engineering, Construction and Facilities Management

BIM Building Information Modeling

IFC Industry Foundation Classes

HVAC Heating, Ventilation and Air Conditioning

XML Extensible Markup Language

## 3. Framework

### 3.1 Architecture

The architecture of railway engineering information model is based on the IFC standard, and is extended according to the requirements of railway engineering, as shown in Figure 3.1. In the Resource Layer, necessary entities about the alignment model is defined within the geometric resources. In the Product Extension module of the Core Layer, the IfcAlignment entity is defined to represent the alignment of the railway. The module of Shared Railway Elements, which includes the common types, the common spatial structures, the common components and the shared property sets, is added in the Interop Layer. Currently, eight disciplines including Alignment, Geology, Subgrade, Bridge, Tunnel, Drainage, Track and Station are extended in the Domain Layer.

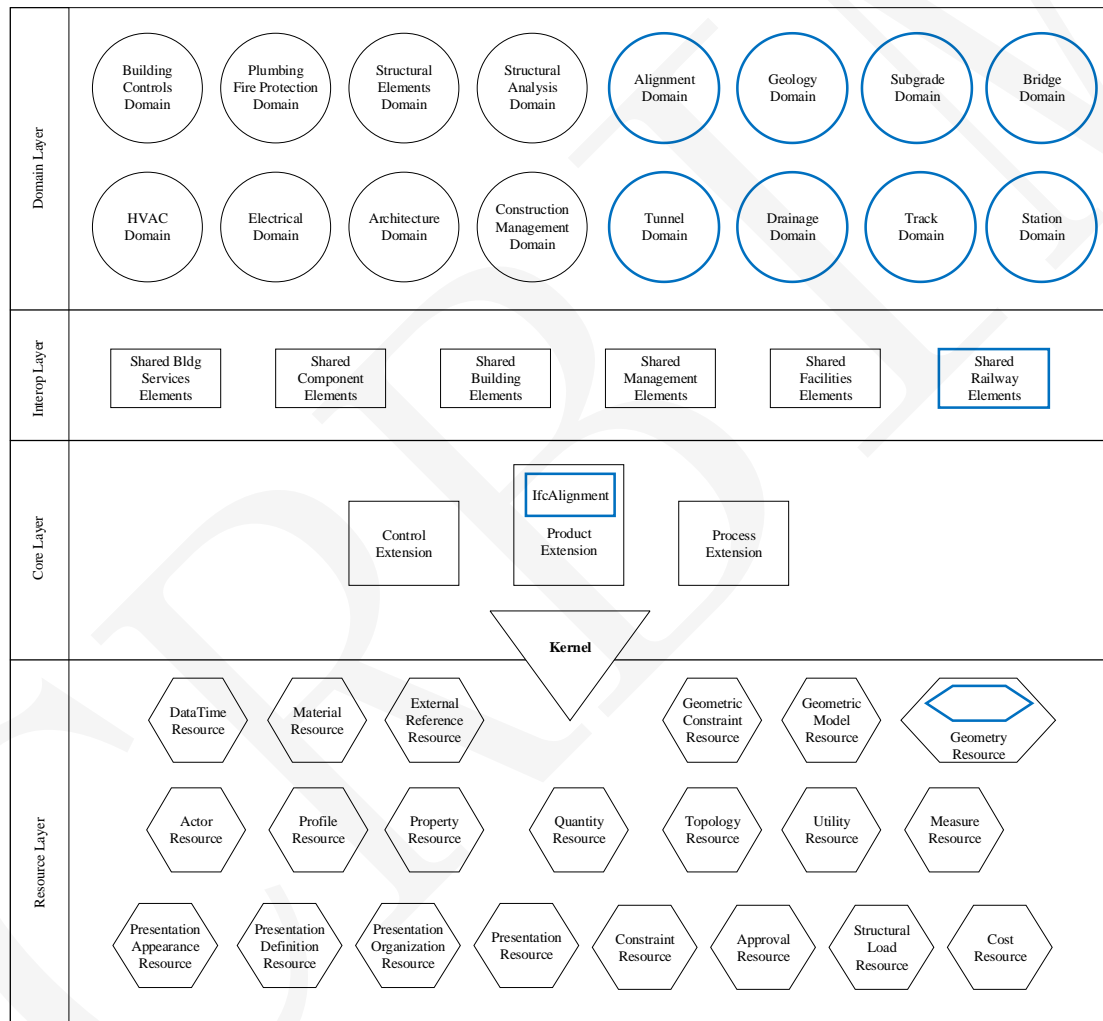

**Figure 3.1 Railway engineering information model architecture**

### 3.2 Railway Engineering Spatial Composition

The spatial structure of railway engineering is illustrated in Figure 3.2. The railway project (IfcProject) may contain one or more railways (IfcRailway) and one or more railway terminals (IfcRailwayTerminal). IfcRailway may consist of one or more alignments (IfcAlignment), one or more tracks (IfcTrack), and one or more sites of tunnel (IfcTunnel), subgrade (IfcSubgrade), bridge

(IfcBridge), station (IfcRailwayStation) and building (IfcBuilding). A railway terminal (IfcRailwayTerminal) may also consist of a series of railways (IfcRailway) and stations (IfcRailwayStation).

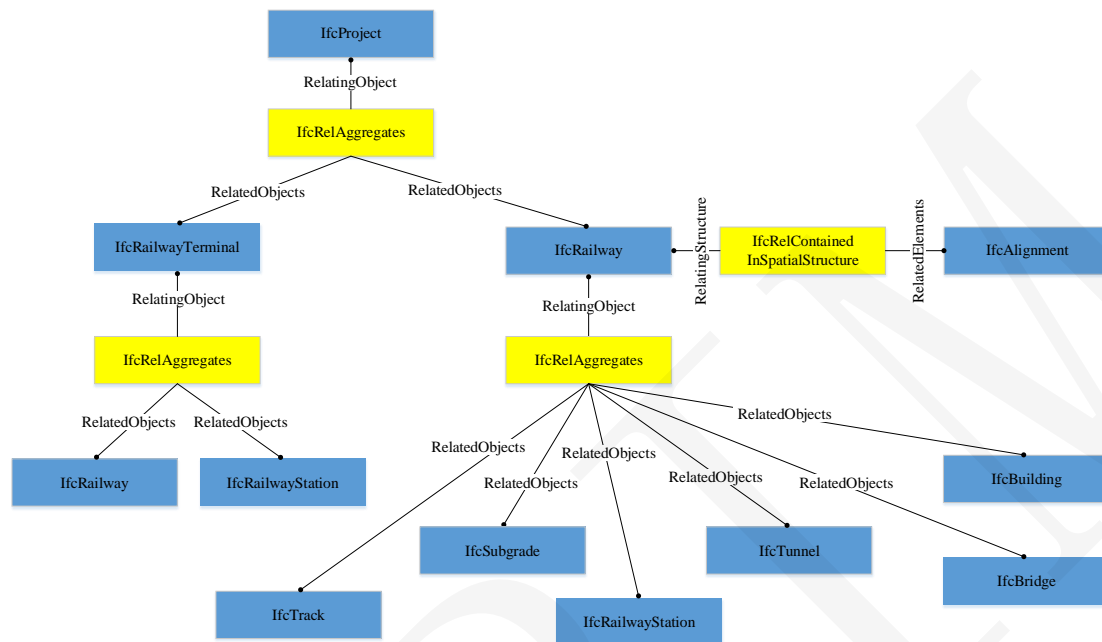

Figure 3.2 Railway engineering spatial composition

## 4. Shared Railway Element Schemas

### 4.1 Shared Types

#### 4.1.1 IfcGeoElementComponentTypeEnum

This enumeration defines the different predefined types of an IfcGeoElementComponent object.

##### Enumerated Item Definitions:

ANCHOREDBOLT;  
 STEELFRAMEUNIT;  
 GEOTEXTILES;  
 COMPOSITEGEOMEMBRANE;  
 GEOGRID;  
 GEOMAT;  
 PERMEABLEHOSE;  
 PRESTRESSEDMETALCORRUGATEDPIPE;  
 SOILNAILING;  
 USERDEFINED;  
 NOTDEFINED.

**EXPRESS Specification:**

```

TYPE IfcGeoElementComponentTypeEnum = ENUMERATION OF
(ANCHOREDBOLT
,STEELFRAMEUNIT
,GEOTEXTILES
,COMPOSITEGEOMEMBRANE
,GEOGRID
,GEOMAT
,PERMEABLEHOSE
,PRESTRESSEDMETALCORRUGATEDPIPE
,SOILNAILING
,USERDEFINED
,NOTDEFINED);
END_TYPE;

```

**4.2 Shared Spatial Structure Elements**

Shared spatial structure elements include IfcCivilStructureElement, IfcRailwayStructureElement and IfcRailway. Figure 4.1 shows the inheritance and derived relationships between each other.

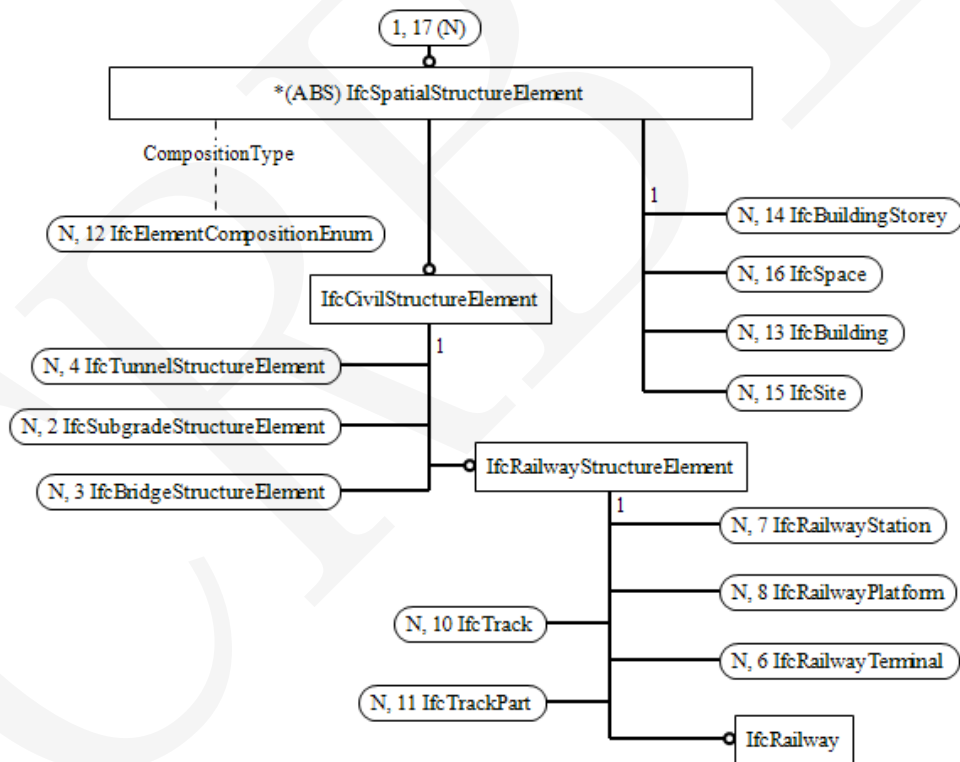

**Figure 4.1 EXPRESS-G diagram for shared spatial structure elements**

**4.2.1 IfcCivilStructureElement**

IfcCivilStructureElement is inherited from IfcSpatialStructureElement in IFC4 and is the supertype of IfcRailyStructureElement, IfcSubgradeStructureElement, IfcBridgeStructureElement and IfcTunnelStructureElement.

**EXPRESS Specification:**

```

ENTITY IfcCivilStructureElement
  SUPERTYPE OF (ONEOF
    (IfcRailwayStructureElement
    ,IfcSubgradeStructureElement
    ,IfcBridgeStructureElement
    ,IfcTunnelStructureElement))
  SUBTYPE OF (IfcSpatialStructureElement);
END_ENTITY;

```

**4.2.2 IfcRailwayStructureElement**

IfcRailwayStructureElement is inherited from IfcCivilStructureElement and is the supertype of IfcRailway, IfcTrack, IfcTrackPart, IfcRailwayTerminal, IfcRailwayStation and IfcRailwayPlatform.

**EXPRESS Specification:**

```

ENTITY IfcRailwayStructureElement
  SUPERTYPE OF (ONEOF
    (IfcRailway, IfcTrack, IfcTrackPart,
    IfcRailwayTerminal, IfcRailwayStation, IfcRailwayPlatform))
  SUBTYPE OF (IfcCivilStructureElement);
END_ENTITY;

```

**4.2.3 IfcRailway**

IfcRailway is used to define one railway line. Usually, the railway line, which is named independently, non-parallel and requires independent engineering quantity statistics, is appropriate to be defined as an IfcRailway object. An IfcRailway object may contain one, two or more center lines of railway and multiple IfcTrack objects, IfcSubgrade objects, IfcBridge objects, IfcTunnel objects, IfcRailwayStation objects and IfcBuilding objects.

**Table 4.1 IfcRailway spatial decomposition**

Spatial Parts	Description
IfcTrack	An IfcRailway object may contain multiple IfcTrack objects.
IfcSubgrade	An IfcRailway object may contain multiple IfcSubgrade objects.
IfcBridge	An IfcRailway object may contain multiple IfcBridge objects.
IfcTunnel	An IfcRailway object may contain multiple IfcTunnel objects.
IfcRailwayStation	An IfcRailway object may contain multiple IfcRailwayStation objects.
IfcBuilding	An IfcRailway object may contain multiple IfcBuilding objects.

**Table 4.2 IfcRailway spatial containment**

Contained Entities	Description
IfcElement	Physical elements can be contained in IfcRailway, but generally should be firstly contained in spatial structure such as IfcBuilding, IfcBridge.

IfcAlignment	An IfcRailway object may contain multiple IfcAlignment objects.
--------------	---

**Table 4.3 Property sets for IfcRailway**

PredefinedType	Name
	Pset_RailwayProject
	Pset_MainTechnicalStandardOfRailway

**EXPRESS Specification:**

```

ENTITY IfcRailway
  SUBTYPE OF (IfcRailwayStructureElement);
END_ENTITY;

```

**4.3 Shared Components**

Shared components include IfcCivilElementComponent, IfcRailwayElementComponent and IfcGeoElementComponent. IfcCivilElementComponent is inherited from IfcElementComponent. IfcRailwayElementComponent and IfcGeoElementComponent are inherited from IfcCivilElementComponent, as shown in Figure 4.2.

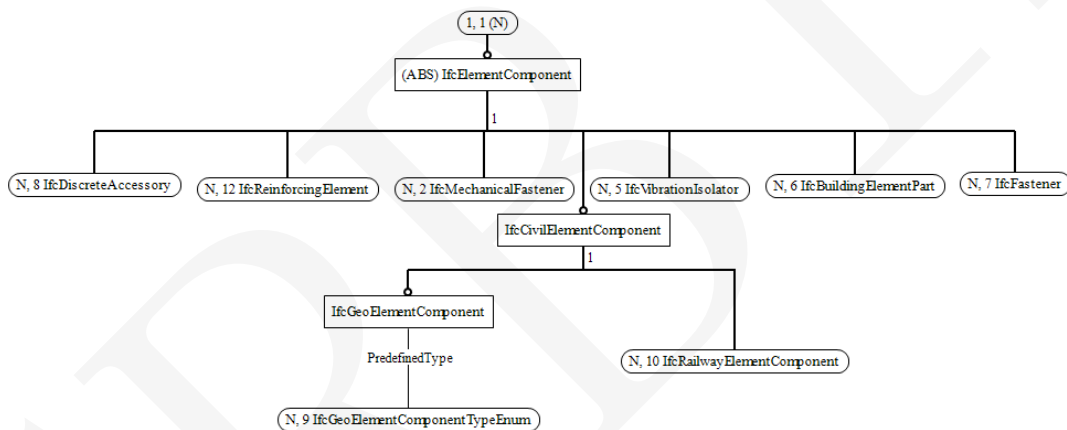

**Figure 4.2 EXPRESS-G diagram for shared components**

**4.3.1 IfcCivilElementComponent**

IfcCivilElementComponent is the supertype of all the components in civil engineering.

**EXPRESS Specification:**

```

ENTITY IfcCivilElementComponent
  SUPERTYPE OF (ONEOF
    (IfcRailwayElementComponent,
     IfcGeoElementComponent))
  SUBTYPE OF (IfcElementComponent);
END_ENTITY;

```

**4.3.2 IfcRailwayElementComponent**

IfcRailwayElementComponent is the supertype of all the components in railway engineering. Currently, IfcRailwayElementComponent is the supertype of IfcTrackElementComponent and IfcEarthingTerminal.

**EXPRESS Specification:**

ENTITY IfcRailwayElementComponent  
 SUPERTYPE OF (ONEOF  
   (IfcTrackElementComponent,  
   IfcEarthingTerminal))  
 SUBTYPE OF (IfcCivilElementComponent);  
 END\_ENTITY;

**4.3.3 IfcGeoElementComponent**

IfcGeoElementComponent defines components relating to geotechnical engineering such as anchor bolts, geotextiles and soil nailing. Specific types of IfcGeoElementComponent are defined by IfcGeoElementComponentTypeEnum.

**Table 4.4 Property sets for IfcGeoElementComponent**

PredefinedType	Name
ANCHOREDBOLT	Pset_ANCHOREDBOLT

**EXPRESS Specification:**

ENTITY IfcGeoElementComponent  
 SUBTYPE OF (IfcCivilElementComponent);  
 PredefinedType: IfcGeoElementComponentTypeEnum;  
 END\_ENTITY;

**Attribute definitions:**

PredefinedType: IfcGeoElementComponent is subdivided into anchored bolt, steel frame unit, geotextile, composite geomembrane, geogrid, geomat, permeable hose, prestressed metal corrugated pipe, soil nailing, etc.

**4.4 Shared Property Sets****4.4.1 Pset\_RailwayProject**

Name: Pset\_RailwayProject

Applicable Entities: IfcRailway

Description: Properties common to all occurrences of IfcRailway.

Property Definitions: See Table 4.5.

**Table 4.5 Property definitions of Pset\_RailwayProject**

Name	Type	Description
DesignedPeriod	TypePropertySingleValue/IfcInteger/Year	Designed period. Indicates the period designed to forecast traffic volume and determine equipment scale.
TargetSpeed	TypePropertySingleValue/IfcInteger/(Km/h)	The maximum target speed.

NatureOfConstruction	TypePropertyEnumeratedValue/PEnum_NatureOfConstruction:NewlyBuiltRailway,EnhancedSecondLineRailEngineering,ElectrifiedRailwayEngineering	The nature of project construction.
RailwayApplication	TypePropertyEnumeratedValue/PEnum_RailwayApplication:PassengerDedicatedLine,IntercityRailway,SuburbanRailway,RailTransit,MixedPassengerAndFreightRailway,FreightRailway	Different types of railway application.
GaugeOfTrack	TypePropertyEnumeratedValue/PEnum_GaugeOfTrack:StandardGaugeRailway,BroadGaugeRailway,NarrowGaugeRailway,Monorail	Distance between two rails.
RailwayCharacterization	TypePropertyEnumeratedValue/PEnum_RailwayCharacterization:NationalRailway,LocalRailway,ExclusiveRailway,IndustrialSiding	Characterization of a railway.
RailwayClassification	TypePropertyEnumeratedValue/PEnum_RailwayClassification:High-Speed Railway,Intercity Railway,Class1 Railroad,Class2 Railroad,Class3 Railroad,Class4 Railroad	Classification of a railway.
Name	TypePropertySingleValue/IfcLabel	Name of a railway.

#### 4.4.2 Pset\_MainTechnicalStandardOfRailway

Name: Pset\_MainTechnicalStandardOfRailway

Applicable Entities: IfcRailway

Description: Properties related to main technical standard of railways.

Property Definitions: See Table 4.6.

**Table 4.6 Property definitions of Pset\_MainTechnicalStandardOfRailway**

Name	Type	Description
NumberOfTrack	TypePropertyEnumeratedValue/PEnum_NumberOfTrack:SingleTrackRailway,DoubleTrackRailway	Number of tracks.
ModeOfTraction	TypePropertyEnumeratedValue/PEnum_ModeOfTraction:Electric Locomotive,Internal Combustion,Stream Locomotive	Mode of traction.
BlockSystem	TypePropertyEnumeratedValue/PEnum_BlockSystem:AutomaticBlock,SemiAutomaticBlock, AutomaticInterStationblock	Type of section block.
RulingGrade	TypePropertySingleValue/IfcReal	Ruling grade.
TractionMass	TypePropertySingleValue/IfcReal/t	Traction mass.
MinimumRadiusOfCurveNormal	TypePropertySingleValue/IfcLengthMeasure/m	The minimum radius of curve in normal condition.



MinimumRadiusOfCurveDifficult	TypePropertySingleValue/IfcLengthMeasure/m	The minimum raidus of curve in difficult condition.
EffectiveLengthOfReceivingDepartureTrack	TypePropertySingleValue/IfcLengthMeasure/m	Effective length of receiving-departure track.
MinimumRadiusOfVerticalCurve	TypePropertySingleValue/IfcLengthMeasure/m	The minimum raildus of vertical curve.
MinimumSlopeLength	TypePropertySingleValue/IfcLengthMeasure/m	The minimum slope length.
MaximumGradientDifference	TypePropertySingleValue/IfcLengthMeasure	The maximum gradient difference.
MiximumClipStraightLine	TypePropertySingleValue/IfcLengthMeasure/m	The minimum clip straight line.
MinimumGradientDifferenceToSetVerticalCurve	TypePropertySingleValue/IfcLengthMeasure	The minimum gradient difference to set vertical curve.

#### 4.4.3 Pset\_ConcreteElementGeneral

Name: Pset\_ConcreteElementGeneral

Applicable Entities: IfcBridge, IfcBridgeElement, IfcBridgePart, IfcTrackSleeper, IfcTrackSlab, IfcTrackConcreteSlab, IfcTrackBase, IfcTunnelLining, IfcTunnelInvertFilling, IfcTunnelPortal, IfcSubgradeStructurePartElement, IfcSubgradeSlopeProtectionElement, IfcSubgradeRetainingStructureElement, IfcSubgradeSubsoilTreatmentElement.

Description: Properties common to all occurrences of concrete elements.

Property Definitions: See Table 4.7.

**Table 4.7 Property definitions of Pset\_ConcreteElementGeneral**

Name	Type	Description
ConstructionMethod	TypePropertyEnumeratedValue/PEnum_ConstructionMethod:In-Situ,Precast	Indicates whether the concrete element is constructed on site or prefabricated. Allowed values are: 'In-Situ' vs 'Precast'.
StructuralClass	TypePropertySingleValue/IfcLabel	The structural class defined for the concrete structure.
StrengthClass	TypePropertySingleValue/IfcLabel	Classification of the concrete strength.
ExposureClass	TypePropertySingleValue/IfcLabel	Classification of exposure to environmental conditions.
ReinforcementVolumeRatio	TypePropertySingleValue/IfcLabel	The required ratio of the effective mass of the reinforcement to the effective volume of the concrete of a

		reinforced concrete structural element.
ReinforcementAreaRatio	TypePropertySingleValue/IfcLabel	The required ratio of the effective area of the reinforcement to the effective area of the concrete At any section of a reinforced concrete structural element.
DimensionalAccuracyClass	TypePropertySingleValue/IfcLabel	Classification designation of the dimensional accuracy requirement according to local standards.
ConstructionToleranceClass	TypePropertySingleValue/IfcLabel	Classification designation of the on-site construction tolerances according to local standards.
ConcreteCover	TypePropertySingleValue/IfcLengthMeasure/m	The protective concrete cover at the reinforcing bars according to local building regulations.
ConcreteCoverAtMainBars	TypePropertySingleValue/IfcLengthMeasure/m	The protective concrete cover at the main reinforcing bars according to local building regulations.
ConcreteCoverAtLinks	TypePropertySingleValue/IfcLengthMeasure/m	The protective concrete cover at the reinforcement links according to local building regulations.
ReinforcementStrengthClass	TypePropertySingleValue/IfcLabel	Classification of the reinforcement strength.
ConcreteAge	TypePropertySingleValue/IfcTime/d	Age of the concrete.
CrackWidth	TypePropertySingleValue/IfcLengthMeasure/m	Width of the crack.
NetConcreteCover	TypePropertySingleValue/IfcLengthMeasure/m	Net concrete cover.
degree of prestressing	TypePropertySingleValue/IfcLabel	Degree of prestressing.
effective prestress	TypePropertySingleValue/IfcPressureMeasure/Pa	Effective prestress.

#### 4.4.4 Pset\_PrecastConcreteElementFabrication

Name: Pset\_PrecastConcreteElementFabrication

Applicable Entities: IfcBridgePart, IfcTrackSleeper, IfcTrackSlab

Description: Properties related to precast concrete fabrication.

Property Definitions: See Table 4.8.

**Table 4.8 Property definitions of Pset\_PrecastConcreteElementFabrication**

Name	Type	Description
TypeDesignator	TypePropertySingleValue/IfcLabel	Type designator for the precast concrete element.
ProductionLotId	TypePropertySingleValue/IfcLabel	The manufacturer's production lot identifier.
SerialNumber	TypePropertySingleValue/IfcLabel	The manufacturer's serial number for the precast concrete element.
PieceMark	TypePropertySingleValue/IfcLabel	Defines a unique piece for production purposes.
AsBuiltLocationNumber	TypePropertySingleValue/IfcLabel	Defines a unique location within a structure, the 'slot' into which the piece was installed.
ActualProductionDate	TypePropertySingleValue/IfcLabel	Production date.
ActualErectionDate	TypePropertySingleValue/IfcLabel	Date erected.

#### 4.4.5 Pset\_PrecastConcreteElementGeneral

Name: Pset\_PrecastConcreteElementGeneral

Applicable Entities: IfcBridgePart, IfcTrackSleeper, IfcTrackSlab

Description: Properties common to all occurrences of precast concrete elements.

Property Definitions: See Table 4.9.

**Table 4.9 Property definitions of Pset\_PrecastConcreteElementGeneral**

Name	Type	Description
TypeDesignator	TypePropertySingleValue/IfcLabel	Type designator for the precast concrete element.
CornerChamfer	TypePropertySingleValue/IfcPositiveLengthMeasure/m	The chamfer in the corners of the precast element.
ManufacturingToleranceClass	TypePropertySingleValue/IfcLabel	Classification designation of the manufacturing tolerances.
FormStrippingStrength	TypePropertySingleValue/IfcPressureMeasure/Pa	The minimum required compressive strength of the concrete at form stripping time.
FreezingResistanceStrength	TypePropertySingleValue/IfcPressureMeasure/Pa	Freezing resistance strength.

LiftingStrength	TypePropertySingleValue/IfcPressureMeasure/Pa	The minimum required compressive strength of the concrete when the concrete element is lifted.
ReleaseStrength	TypePropertySingleValue/IfcPressureMeasure/Pa	The minimum required compressive strength of the concrete when the tendon stress is released.
MinimumAllowableSupportLength	TypePropertySingleValue/IfcPositiveLengthMeasure/m	The minimum allowable support length.
InitialTension	TypePropertySingleValue/IfcPressureMeasure/Pa	The initial stress of the tendon.
TendonRelaxation	TypePropertySingleValue/IfcLabel	The maximum allowable relaxation of the tendon.
TransportationStrength	TypePropertySingleValue/IfcPressureMeasure/Pa	The minimum required compressive strength of the concrete required for transportation.
SupportDuringTransportDescription	TypePropertySingleValue/IfcLabel	Textual description of how the concrete element is supported during transportation.
SupportDuringTransportDocReference	TypePropertySingleValue/IfcLabel	Reference to an external document defining how the concrete element is supported during transportation.
HollowCorePlugging	TypePropertySingleValue/IfcLabel	A descriptive label for how the hollow core ends are treated.
CamberAtMidspan	TypePropertySingleValue/IfcPositiveLengthMeasure/m	The camber deflection, measured from the midpoint of a cambered face of a piece to the midpoint of the chord joining the ends of the same face.
BatterAtStart	TypePropertySingleValue/IfcCurvatureMeasure/(rad/m)	The angle, in radians, by which the formwork at the starting face of a piece is to be rotated from the vertical in order to compensate for the

		rotation of the face that will occur once the piece is stripped from its form, inducing camber due to eccentric prestressing.
BatterAtEnd	TypePropertySingleValue/IfcCurvatureMeasure/(rad/m)	The angle, in radians, by which the formwork at the ending face of a piece is to be rotated from the vertical in order to compensate for the rotation of the face that will occur once the piece is stripped from its form, inducing camber due to eccentric prestressing.
Twisting	TypePropertySingleValue/IfcCurvatureMeasure/(rad/m)	The angle, in radians, through which the end face of a precast piece is rotated with respect to its starting face, along its longitudinal axis, as a result of non-aligned supports.
Shortening	TypePropertySingleValue/IfcLabel	The ratio of the distance by which a precast piece is shortened after release from its form to its original length.
PieceMark	TypePropertySingleValue/IfcLabel	A unique piece for production purposes.
DesignLocationNumber	TypePropertySingleValue/IfcLabel	A unique location within a structure.

#### 4.4.6 Pset\_GeologicalCondition

Name: Pset\_GeologicalCondition

Applicable Entities: IfcBridge, IfcTunnel, IfcBridgePart

Description: Properties related to geological condition.

Property Definitions: See Table 4.10.

**Table 4.10 Property definitions of Pset\_GeologicalCondition**

Name	Type	Description
BasicSeismicIntensity	TypePropertyEnumeratedValue/PEnum_BasicSeismicIntensity: level6, level7, level8, level9	Basic seismic intensity.

SeismicPeakGroundAcceleration	TypePropertySingleValue/IfcAccelerationMeasure/(m/s <sup>2</sup> )	Seismic peak ground acceleration.
SeismicGroundMotionParameterZonation	TypePropertyEnumeratedValue/PEnum_SeismicGroundMotionParameterZonation:Region1, Region2, Region3	Seismic ground motion parameter zonation.
CharacteristicPeriodOfTheSeismicResponseSpectrum	TypePropertyEnumeratedValue/PEnum_CharacteristicPeriodOfTheSeismicResponseSpectrum: 0.25, 0.3, 0.35, 0.4, 0.45, 0.55, 0.65, 0.75, 0.9	Characteristic period of the seismic response spectrum.
SiteCategory	TypePropertyEnumeratedValue/PEnum_SiteCategory: I , II , III, IV	Site category.
Classification of Surrounding Rock	TypePropertyEnumeratedValue/PEnum_classification of surrounding rock: II , III,IV, V , VI	Classification of surrounding rock.
Groundwater Corrosion	TypePropertySingleValue/IfcLabel	Groundwater corrosion.
Coldest Month of The Average Temperature	TypePropertySingleValue/IfcThermodynamicTemperatureMeasure/ °C	The coldest month of the average temperature.
Frozen Depth of Soil	TypePropertySingleValue/IfcLengthMeasure/m	The frozen depth of soil.

#### 4.4.7 Pset\_StandardDrawingNumber

Name: Pset\_StandardDrawingNumber

Applicable Entities: IfcBridge, IfcBridgePart, IfcBridgeBearing, IfcExpansionInstallation, IfcPipe

Description: The number of standard drawing.

Property Definitions: See Table 4.11.

**Table 4.11 Property definitions of Pset\_StandardDrawingNumber**

Name	Type	Description
StandardDrawingNumberType	TypePropertyEnumeratedValue/IfcLabel/PEnum_StandardDrawingNumberType:MinisterialLevelStandardDrawing,EnterpriseLevelStandardDrawing,ProjectLevelStandardDrawing,Others	Type of the standard drawing.
StandardDrawingNumber	TypePropertySingleValue/IfcLabel	Number of the standard drawing.

#### 4.4.8 Pset\_RailwayElementCommon

Name: Pset\_RailwayElementCommon

Applicable Entities: IfcCivilElement, IfcCivilStructureElement, IfcPipeSegment

Description: Common properties of all occurrences of railway.

Property Definitions: See Table 4.12.

**Table 4.12 Property definitions of Pset\_RailwayElementCommon**

Name	Type	Description
Reference	TypePropertySingleValue/IfcIdentifier	Reference.
Status	TypePropertyEnumeratedValue/IfcLabel/PEnum_RailwayElementStatus:NEW,EXISTING,DEM	The status of railway elements.

	OLISH,TEMPORARY,OTHER, NOTKNOWN,UNSET	
--	--	--

#### 4.4.9 Pset\_ANCHOREDBOLT

Name: Pset\_ANCHOREDBOLT

Applicable Entities: IfcGeoElementComponent/ ANCHOREDBOLT

Description: Properties common to different types of anchored bolts.

Property Definitions: See Table 4.13.

**Table 4.13 Property definitions of Pset\_ANCHOREDBOLT**

Name	Type	Description
anchorholediameter	TypePropertySingleValue /IfcLengthMeasure/m	Diameter of anchor hole
boltdiameter	TypePropertySingleValue /IfcLengthMeasure/m	Diameter of bolt
anchorlength	TypePropertySingleValue /IfcLengthMeasure/m	Length of anchor

### 5. Alignment Schema

This schema refers to IFC4x1 Alignment Extension which is released by buildingSMART in 2015. We seek to keep consistent with existed buildingSMART standards as much as possible.

In IFC4x1 Alignment Extension, linear reference is used to position elements. In this schema, chainage system is introduced to adapt to China railway engineering.

In IFC4x1 Alignment Extension, IfcClothoidalArcSegment2D is defined as transition curve. In this schema, IfcTransitionCurve2D is defined to represent universal transition curves.

#### 5.1 Schema Definition

All the entities defined in the alignment schema are shown in Table 5.1.

**Table 5.1 Entities defined in Alignment schema**

#	Name	Description
1	IfcAlignment	
2	IfcAlignment2DHorizontal	
3	IfcAlignment2DVertical	
4	IfcAlignment2DSegment	
5	IfcAlignment2DHorizontalSegment	
6	IfcAlignment2DVerticalSegment	
7	IfcCurveSegment2D	
8	IfcLineSegment2D	
9	IfcCircularArcSegment2D	
10	IfcTransitionCurve2D	
11	IfcAlignment2DVerSegLine	
12	IfcAlignment2DVerSegCircularArc	
13	IfcAlignment2DVerSegParabolicArc	
14	IfcChainageSystem	
15	IfcChainageSystemSegment	

IfcAlignment is used to define a reference system to position elements mainly for linear construction works, such as roads, rails, etc. IfcAlignment is composed of IfcAlignment2DHorizontal, IfcAlignment2DVertical and IfcChainageSystem. The alignment in 3D space is combined by IfcAlignment2DHorizontal and IfcAlignment2DVertical.

An IfcAlignment2DHorizontal is a linear reference projected onto the horizontal x/y plane, which is composed of a group of consecutively connected IfcAlignment2DHorizontalSegments. Each IfcAlignment2DHorizontalSegment has an IfcCurveSegment2D. IfcCurveSegment2D can be divided into IfcLineSegment2D, IfcCircularArcSegment2D and IfcTransitionCurve2D. The adjacent IfcAlignment2DHorizontalSegments may have tangential continuity or point continuity.

An IfcAlignment2DVertical is an elevation profile along the horizontal alignment, which is composed of a group of consecutively connected IfcAlignment2DVerticalSegments. IfcAlignment2DVertical can be divided into IfcAlignment2DVerSegLine, IfcAlignment2DVerSegCircularArc and IfcAlignment2DVerSegParabolicArc. The adjacent IfcAlignment2DVerticalSegments may have tangential continuity or point continuity.

IfcChainageSystem is defined by a group of consecutively connected IfcChainageSystemSegments.

Figure 5.1 shows the relationships of all the classes in this alignment schema.



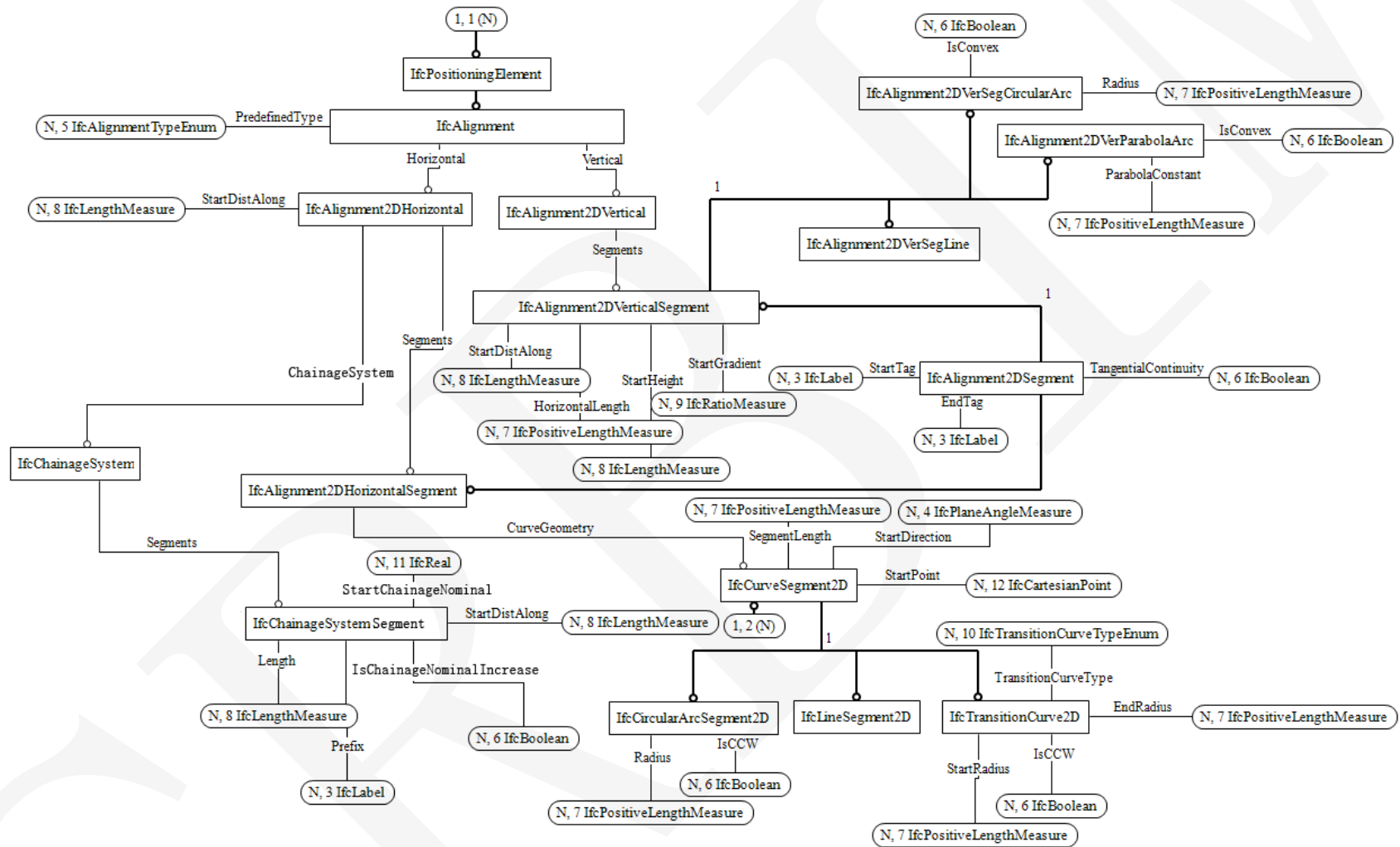

Figure 5.1 EXPRESS-G diagram for alignment

## 5.2 Type Definition

### 5.2.1 IfcAlignmentTypeEnum

IfcAlignmentTypeEnum defines the different types of reference methods to locate by referencing this alignment.

#### Enumerated Item Definitions:

ABSOLUTE;  
CHAINAGESYSTEM;  
USERDEFINED;  
NOTDEFINED.

#### EXPRESS Specification:

```
TYPE IfcAlignmentTypeEnum =ENUMERATION OF  
    (ABSOLUTE  
    ,CHAINAGESYSTEM  
    ,USERDEFINED  
    ,NOTDEFINED  
    );  
END_TYPE;
```

### 5.2.2 IfcTransitionCurveTypeEnum

IfcTransitionCurveTypeEnum defines the different types of transition curves.

#### Enumerated Item Definitions:

BLOSSCURVE;  
CLOTHOIDCURVE;  
SINUSOIDALCURVE;  
COSINSOIDALCURVE;  
CUBICPARABOLAS;  
USERDEFINED;  
NOTDEFINED.

#### EXPRESS Specification:

```
TYPE IfcTransitionCurveTypeEnum =ENUMERATION OF  
    (BLOSSCURVE  
    ,CLOTHOIDCURVE  
    ,SINUSOIDALCURVE  
    ,COSINSOIDALCURVE  
    ,CUBICPARABOLAS  
    ,USERDEFINED  
    ,NOTDEFINED  
    );
```

END\_TYPE;

### 5.3 Entity Definition

#### 5.3.1 IfcAlignment

##### 5.3.1.1 Entity definition

IfcAlignment is used to define a reference system to position elements mainly for linear construction works, such as roads, rails, etc. IfcAlignment is a subtype of IfcPositioningElement, which is composed of IfcAlignment2DHorizontal, IfcAlignment2DVertical and IfcChainageSystem. Usually, the alignment in 3D space is combined by the horizontal and vertical alignment. An IfcAlignment2DHorizontal is a linear reference projected onto the horizontal x/y plane. An IfcAlignment2DVertical is an elevation profile along the horizontal alignment. The horizontal alignment can be shared by several alignments with its own vertical alignments.

Valid representations of IfcAlignment include:

- (1) a complete definition including a single horizontal, vertical (represented by their alignment segments) and a 3D alignment;
- (2) a definition including a single horizontal and vertical alignment (represented by their alignment segments) without a generated 3D alignment;
- (3) a definition only including a horizontal alignment (represented by its horizontal alignment segments) without a vertical and 3D alignment;
- (4) a definition only including a horizontal alignment by a simple 2D line representation without alignment segments (such as in very early planning phases or as a map representation);
- (5) a definition only including a 3D alignment (such as coming from a survey) without horizontal and vertical alignment segments.

An IfcGroup entity can aggregate corresponding alignments to form an alignment system.

##### 5.3.1.2 Attribute definitions

**Table 5.2 Attributes of IfcAlignment**

#	Attribute	Type	Cardinality	Description
1	PredefinedType	IfcAlignmentTypeEnum	[0:1]	Reference methods, see definition in 5.2.1.
2	Horizontal	IfcAlignment2DHorizontal	[0:1]	Horizontal alignment.
3	Vertical	IfcAlignment2DVertical	[0:1]	Vertical alignment.
4	LinearRefMethod	IfcLabel	[0:1]	Descriptive names for the Linear Referencing Method used to position items along the alignment.

##### 5.3.1.3 EXPRESS specification

ENTITY IfcAlignment

SUBTYPE OF (IfcPositioningElement);

PredefinedType: OPTIONAL IfcAlignmentTypeEnum;

Horizontal: OPTIONAL IfcAlignment2DHorizontal;

Vertical: OPTIONAL IfcAlignment2DVertical;

LinearRefMethod: OPTIONAL IfcLabel;

WHERE

ValidCombination: (EXISTS(Horizontal) AND EXISTS(Vertical)) OR (EXISTS(Horizontal) AND NOT(EXISTS(Vertical))) OR (NOT(EXISTS(Horizontal)) AND NOT(EXISTS(Vertical)));

END\_ENTITY;

### 5.3.2 IfcAlignment2DHorizontal

#### 5.3.2.1 Entity definition

An IfcAlignment2DHorizontal is a linear reference projected onto the horizontal x/y plane. The horizontal alignment is defined by segments (IfcAlignment2DHorizontalSegment) that are consecutively connected. Each IfcAlignment2DHorizontalSegment contains an IfcCurveSegment2D. By default, the tangential continuity is used between adjacent IfcAlignment2DHorizontalSegments, but a point continuity is also allowed.

#### 5.3.2.2 Attribute definitions

**Table 5.3 Attributes of IfcAlignment2DHorizontal**

#	Attribute	Type	Cardinality	Description
1	StartDistAlong	IfcLengthMeasure	[0:1]	The value of the distance along the start of the horizontal alignment. If omitted (standard) it is set to zero.
2	Segments	IfcAlignment2DHorizontalSegment	L[1:?]	An ordered list of unique horizontal alignment segments, each (but the last) are connected end to start.
3	ChainageSystem	IfcChainageSystem	[0:1]	Chainage System. If omitted, the chainage value at the start point is 0, and the value at the end point is the value of length of the alignment.
4	ToAlignment	IfcAlignment@Horizontal	S[1:?]	Link to the IfcAlignment for which it defines the horizontal alignment. More than one IfcAlignment can be linked – in this case, the horizontal alignment is shared by several alignments with its own vertical alignments.

### 5.3.2.3 EXPRESS specification

```
ENTITY IfcAlignment2DHorizontal;  
  StartDistAlong: OPTIONAL IfcLengthMeasure;  
  Segments: LIST [1:?] OF IfcAlignment2DHorizontalSegment;  
  ChainageSystem: OPTIONAL IfcChainageSystem;  
  INVERSE  
    ToAlignment: SET [1:?] OF IfcAlignment FOR Horizontal;  
END_ENTITY;
```

### 5.3.3 IfcAlignment2DVertical

#### 5.3.3.1 Entity definition

An IfcAlignment2DVertical is an elevation profile along the horizontal alignment. The vertical alignment is defined by segments (IfcAlignment2DVerticalSegment) that are connected end-to-start. The transition at the segment connection is tangential continuity by default, but a point continuity is also allowed.

#### 5.3.3.2 Attribute definitions

**Table 5.4 Attributes of IfcAlignment2DVertical**

#	Attribute	Type	Cardinality	Description
1	Segments	IfcAlignment2DVerticalSegment	L[1:?]	An ordered list of unique vertical alignment segments, each (but the last) are jointed end-to-start
2	ToAlignment	IfcAlignment@Vertical	S[1:1]	Link to the IfcAlignment for which it defines the vertical alignment. Only one IfcAlignment can be linked, a vertical alignment can not be shared by several alignments.

#### 5.3.3.3 EXPRESS specification

```
ENTITY IfcAlignment2DVertical;  
  Segments: LIST [1:?] OF IfcAlignment2DVerticalSegment;  
  INVERSE  
    ToAlignment: SET[1:1] OF IfcAlignment FOR Vertical;  
END_ENTITY;
```

### 5.3.4 IfcAlignment2DSegment

#### 5.3.4.1 Entity definition

IfcAlignment2DSegment is an abstract entity defining common information about horizontal and vertical alignment segments, which is the supertype of

IfcAlignment2DHorizontalSegment and IfcAlignment2DVerticalSegment. It is an abstract class which means it can not be instantiated.

### 5.3.4.2 Attribute definitions

**Table 5.5 Attributes of IfcAlignment2DSegment**

#	Attribute	Type	Cardinality	Description
1	TangentialContinuity	IfcBoolean	[0:1]	Connectivity between the continuous segments is not enforced to be tangential. Setting "TangentialContinuity" to True means that the current segment shall continue with tangential continuity to the previous one.
2	StartTag	IfcLabel	[0:1]	Tag to annotate the start point of the alignment segment.
3	EndTag	IfcLabel	[0:1]	Tag to annotate the end point of the alignment segment.

### 5.3.4.3 EXPRESS specification

```

ENTITY IfcAlignment2DSegment
  ABSTRACT SUPERTYPE OF (ONEOF(IfcAlignment2DHorizontalSegment,
  IfcAlignment2DVerticalSegment));
  TangentialContinuity: OPTIONAL IfcBoolean;
  StartTag: OPTIONAL IfcLabel;
  EndTag: OPTIONAL IfcLabel;
END_ENTITY;

```

### 5.3.5 IfcAlignment2DHorizontalSegment

#### 5.3.5.1 Entity definition

IfcAlignment2DHorizontal is composed of a list of IfcAlignment2DHorizontalSegments. IfcAlignment2DHorizontalSegment is a subtype of IfcAlignment2DSegment, defined in the x/y coordinate space. An IfcAlignment2DHorizontalSegment contains an IfcCurveSegment2D to represent its geometrical information.

#### 5.3.5.2 Attribute definitions

**Table 5.6 Attributes of IfcAlignment2DHorizontalSegment**

#	Attribute	Type	Cardinality	Description
1	CurveGeometry	IfcCurveSegment2D	[1:1]	Geometric representation of the horizontal alignment within the 2D X/Y coordinate space.
2	ToHorizontal	IfcAlignment2DHorizontal@Segments	S[1:1]	Link to the IfcAlignment2DHorizontal to which this horizontal segment belongs.

### 5.3.5.3 EXPRESS specification

```

ENTITY IfcAlignment2DHorizontalSegment
  SUBTYPE OF (IfcAlignment2DSegment);
  CurveGeometry: IfcCurveSegment2D;
  INVERSE
  ToHorizontal: SET[1:1] OF IfcAlignment2DHorizontal FOR Segments;
END_ENTITY;

```

### 5.3.6 IfcAlignment2DVerticalSegment

#### 5.3.6.1 Entity definition

An IfcAlignment2DVertical is composed of a set of IfcAlignment2DVerticalSegments. As an abstract class, IfcAlignment2DVerticalSegment is the supertype of IfcAlignment2DVerSegLine and IfcAlignment2DVerSegCircularArc, defining some common information.

#### 5.3.6.2 Attribute definitions

**Table 5.7 Attributes of IfcAlignment2DVerticalSegment**

#	Attribute	Type	Cardinality	Description
1	StartDistAlong	IfcLengthMeasure	[1:1]	Distance from the start point of the alignment, along the horizontal alignment.
2	HorizontalLength	IfcPositiveLengthMeasure	[1:1]	Length measured as distance along the horizontal alignment of the segment.
3	StartHeight	IfcLengthMeasure	[1:1]	Elevation in Z of the start point relative to the IfcAlignment coordinate system.
4	StartGradient	IfcRatioMeasure	[1:1]	Gradient of the tangent of the vertical segment at the start point. It is provided as a ratio measure.
5	ToVertical	IfcAlignment2DVertical@Segments	S[1:1]	Link to the IfcAlignment2DVertical to which this vertical segment belongs.

#### 5.3.6.3 EXPRESS specification

```

ENTITY IfcAlignment2DVerticalSegment
  ABSTRACT SUPERTYPE OF (ONEOF(IfcAlignment2DVerSegCircularArc,
  IfcAlignment2DVerSegLine, IfcAlignment2DVerSegParabolicArc))
  SUBTYPE OF (IfcAlignment2DSegment);
  StartDistAlong: IfcLengthMeasure;
  HorizontalLength: IfcPositiveLengthMeasure;
  StartHeight: IfcLengthMeasure;
  StartGradient: IfcRatioMeasure;
  INVERSE
  ToVertical: SET[1:1] OF IfcAlignment2DVertical FOR Segments;
END_ENTITY;

```

### 5.3.7 IfcCurveSegment2D

#### 5.3.7.1 Entity definition

IfcCurveSegment2D is an abstract class, which is the supertype of IfcLineSegment2D, IfcCircularArcSegment2D and IfcTransitionCurve2D. It defines some common geometric attributes.

#### 5.3.7.2 Attribute definitions

**Table 5.8 Attributes of IfcCurveSegment2D**

#	Attribute	Type	Cardinality	Description
1	StartPoint	IfcCartesianPoint	[1:1]	The x/y coordinates of the start point of the 2D curve, defined by a 2D Cartesian point.
2	StartDirection	IfcPlaneAngleMeasure	[1:1]	The direction of the tangent at the start point. Direction value 0.0 indicates a curve with a start tangent along the positive x-axis. Values increase counter-clockwise, and decrease clockwise. Values larger than a full circle ( $> 360^\circ $ or $> 2\pi $ ) shall not be used.
3	SegmentLength	IfcPositiveLengthMeasure	[1:1]	The length along the curve

#### 5.3.7.3 EXPRESS specification

```
ENTITY IfcCurveSegment2D
  ABSTRACT SUPERTYPE OF (ONEOF(IfcCircularArcSegment2D, IfcTransitionCurve2D,
  IfcLineSegment2D))
  SUBTYPE OF (IfcBoundedCurve);
  StartPoint: IfcCartesianPoint;
  StartDirection: IfcPlaneAngleMeasure;
  SegmentLength: IfcPositiveLengthMeasure;
END_ENTITY;
```

### 5.3.8 IfcLineSegment2D

#### 5.3.8.1 Entity definition

The line segment is defined using the inherited start point, start distance and segment length parameter. IfcLineSegment2D is a subtype of IfcCurveSegment2D.

#### 5.3.8.2 Attribute definitions

All attributes are inherited from IfcCurveSegment2D.

#### 5.3.8.3 EXPRESS specification

```
ENTITY IfcLineSegment2D
  SUBTYPE OF (IfcCurveSegment2D);
```



END\_ENTITY;

### 5.3.9 IfcCircularArcSegment2D

#### 5.3.9.1 Entity definition

IfcCircularArcSegment2D defines a circular arc segment in 2D space, which is a subtype of IfcCurveSegment2D.

#### 5.3.9.2 Attribute definitions

**Table 5.9 Attributes of IfcCircularArcSegment2D**

#	Attribute	Type	Cardinality	Description
1	Radius	IfcPositiveLengthMeasure	[1:1]	The radius of the circular arc.
2	IsCCW	IfcBoolean	[1:1]	Indicates the deflecting orientation of the circular arc. Boolean="true" means counter-clockwise or "to the left", and Boolean="false" means clockwise or "to the right".

#### 5.3.9.3 EXPRESS specification

```
ENTITY IfcCircularArcSegment2D
  SUBTYPE OF (IfcCurveSegment2D);
  Radius: IfcPositiveLengthMeasure;
  IsCCW: IfcBoolean;
END_ENTITY;
```

### 5.3.10 IfcTransitionCurve2D

#### 5.3.10.1 Entity definition

IfcTransitionCurve2D defines a bounded 2D curve transiting two 2D curves with continuous curvature, which is a subtype of IfcCurveSegment2D.

#### 5.3.10.2 Attribute definitions

**Table 5.10 Attributes of IfcTransitionCurve2D**

#	Attribute	Type	Cardinality	Description
1	StartRadius	IfcPositiveLengthMeasure	[1:1]	The radius of the transition curve at the start point. If the radius is not provided by a value, i.e. being "NIL" it is interpreted as INFINITE – the startPoint is at the point, where the curve does not have a curvature.
2	IsCCW	IfcBoolean	[1:1]	Indicates whether the transition curve goes counter-clockwise as seen from the start point and start direction.

3	EndRadius	IfcPositiveLengthMeasure	[1:1]	The radius of the transition curve at the end point.
4	TransitionCurveType	IfcTransitionCurveTypeEnum	[1:1]	The type of the transition curve. For detail, see 5.2.2.

### 5.3.10.3 EXPRESS specification

```

ENTITY IfcTransitionCurve2D
  SUBTYPE OF (IfcCurveSegment2D);
  StartRadius: IfcPositiveLengthMeasure;
  IsCCW: IfcBoolean;
  EndRadius: IfcPositiveLengthMeasure;
  TransitionCurveType: IfcTransitionCurveTypeEnum;
END_ENTITY;

```

### 5.3.11 IfcAlignment2DVerSegLine

#### 5.3.11.1 Entity definition

The vertical straight segment is defined as a line using the inherited attributes from IfcAlignment2DVerticalSegment.

#### 5.3.11.2 Attribute definitions

The attributes are inherited from IfcAlignment2DVerticalSegment.

#### 5.3.11.3 EXPRESS specification

```

ENTITY IfcAlignment2DVerSegLine
  SUBTYPE OF (IfcAlignment2DVerticalSegment);
END_ENTITY;

```

### 5.3.12 IfcAlignment2DVerSegCircularArc

#### 5.3.12.1 Entity definition

The vertical circular arc segment is defined as an arc using the inherited attributes from IfcAlignment2DVerticalSegment. IfcAlignment2DVerSegCircularArc is a subtype of IfcAlignment2DVerticalSegment.

#### 5.3.12.2 Attribute definitions

**Table 5.11 Attributes of IfcAlignment2DVerSegCircularArc**

#	Attribute	Type	Cardinality	Description
1	Radius	IfcPositiveLengthMeasure	[1:1]	The radius of the circular arc.
2	IsConvex	IfcBoolean	[1:1]	The orientation of the circular arc, convex (Boolean="true") means decreasing gradient along the arc at the beginning, concave (Boolean="false") means increasing gradient along the arc at the beginning.

#### 5.3.12.3 EXPRESS specification

```

ENTITY IfcAlignment2DVerSegCircularArc
  SUBTYPE OF (IfcAlignment2DVerticalSegment);
  Radius: IfcPositiveLengthMeasure;
  IsConvex: IfcBoolean;
END_ENTITY;

```

### 5.3.13 IfcAlignment2DVerSegParabolicArc

#### 5.3.13.1 Entity definition

The vertical parabolic segment is defined as a parabola using the inherited attributes from IfcAlignment2DVerticalSegment.

#### 5.3.13.2 Attribute definitions

**Table 5.12 Attributes of IfcAlignment2DVerSegParabolicArc**

#	Attribute	Type	Cardinality	Description
1	ParabolaConstant	IfcPositiveLengthMeasure	[1:1]	The parabola constant is provided by the “minimum parabola radius”, the true radius of a parabola at its vertical axis (the zero-gradient point of the parabola).
2	IsConvex	IfcBoolean	[1:1]	Orientation of the parabolic arc, convex (Boolean=“true”) means that the minimum radius is the distance between the vertex and the center point along the positive direction of the vertical axis, and concave (Boolean=“false”) means along the negative direction of the vertical axis.

#### 5.3.13.3 EXPRESS specification

```

ENTITY IfcAlignment2DVerSegParabolicArc
  SUBTYPE OF (IfcAlignment2DVerticalSegment);
  ParabolaConstant: IfcPositiveLengthMeasure;
  IsConvex: IfcBoolean;
END_ENTITY;

```

### 5.3.14 IfcChainageSystem

The IfcAlignment published by buildingSMART recommends to use LRMs (Linear Referencing Method System) in ISO19148 to specify a linearly referenced location. The positioning expression must have Linear Element, Linear Referencing Method and Distance Expression. LRM specifies whether the measurement is absolute, relative or interpolative. The absolute type is the simplest method of LRMs.

In China, the alignment might be modified with various reasons during railway design, resulting in discontinuous chainage values in the same alignment. It is not convenient for

participants to communicate with each other using absolute linear referencing, because the distance expression at the same position will be changed when the alignment is locally modified. Hence, a mechanism named chainage system is added to minimize the impact of alignment changes. We add CHAINAGESYSTEM to the IfcAlignment predefined types. With the help of the chainage system, it is possible to set the "broken chainage", where the chainage value before a point and the value after the point are discontinuous to achieve the stability of chainage of a railway.

#### 5.3.14.1 Entity definition

IfcChainageSystem is composed of a set of IfcChainageSystemSegments connected end-to-start. The chainage is continuous in an IfcChainageSystemSegment. The chainage values at connection points may be different in different chainage segments, as shown in Figure 5.2.

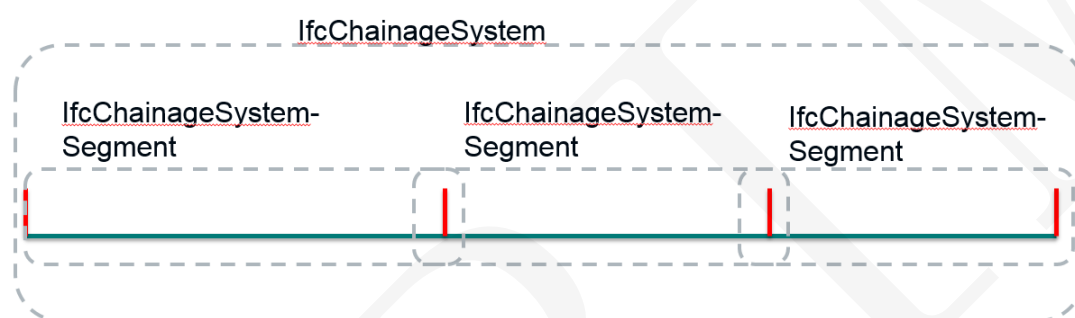

Figure 5.2 Schematic diagram of IfcChainageSystem

#### 5.3.14.2 Attribute definitions

Table 5.13 Attributes of IfcChainageSystem

#	Attribute	Type	Cardinality	Description
1	Segments	IfcChainageSystemSegment	L[1:?]	An ordered list of unique chainage system segments, each are jointed end-to-start.
2	ToHorizontal	IfcAlignment2DHorizontal @ChainageSystem	S[1:1]	Link to the horizontal alignment.

#### 5.3.14.3 EXPRESS specification

```

ENTITY IfcChainageSystem
  Segments: LIST [1:?] OF IfcChainageSystemSegment;
  INVERSE
  ToHorizontal: SET [1:1] OF IfcAlignment2DHorizontal FOR ChainageSystem;
END_ENTITY;

```

#### 5.3.15 IfcChainageSystemSegment

##### 5.3.15.1 Entity definition

IfcChainageSystemSegment defines a continuous segment in IfcChainageSystem, in which the chainage value is continuous. IfcChainageSystemSegment is described by (see Figure 5.3)

- 1) StartDistAlong: The distance to the start point of the alignment along the horizontal alignment.

- 2) Length: Horizontal length.
- 3) StartChainageNominal: The nominal chainage value of the start of the chainage segment.
- 4) IsChainageNominalIncrease: Whether the chainage value is increased along the direction of the alignment.
- 5) Prefix: The prefix string before the chainage value.

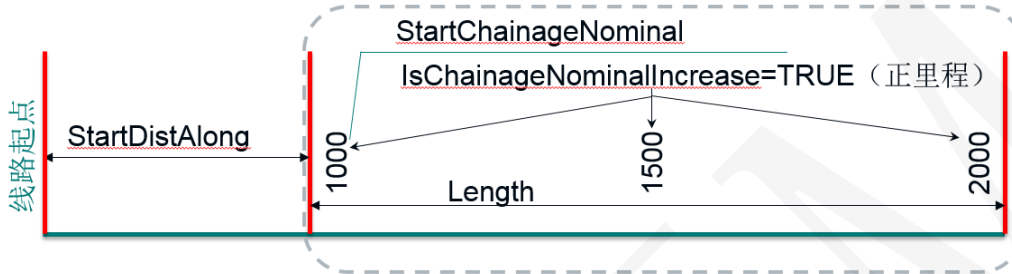

Figure 5.3 Schematic diagram of IfcChainageSystemSegment

### 5.3.15.2 Attribute definitions

Table 5.14 Attributes of IfcChainageSystemSegment

#	Attribute	Type	Cardinality	Description
1	StartDistAlong	IfcLengthMeasure	[1:1]	The distance to the start of the alignment along the horizontal alignment.
2	Length	IfcLengthMeasure	[1:1]	The length of segment.
3	StartChainageNominal	IfcReal	[1:1]	The nominal chainage value at the start point of the chainage segment. The value of the end point is calculated by StartChainageNominal + Length if IsChainageNominalIncrease is True, or -Length.
4	IsChainageNominalIncrease	IfcBoolean	[1:1]	Whether the chainage is increased along the direction of alignment.
5	Prefix	IfcLabel	[1:1]	The prefix string before the chainage value.
6	ToChainageSystem	IfcChainageSystem @ Segments	S[1:1]	Link to the chainage system.

### 5.3.15.3 EXPRESS specification

```

ENTITY IfcChainageSystemSegment
  StartDistAlong: IfcLengthMeasure;
  Length: IfcLengthMeasure;
  StartChainageNominal: IfcReal;

```

IsChainageNominalIncrease: IfcBoolean;  
 Prefix: IfcLabel;  
 INVERSE  
 ToChainageSystem: SET [1:1] OF IfcChainageSystem FOR Segments;  
 END\_ENTITY;

## 5.4 Property Set Definition

### 5.4.1 Pset\_Alignment

Name: Pset\_Alignment

Applicable Entities: IfcAlignment

Description: Property set for alignment.

Property Definitions: See Table 5.15.

**Table 5.15 Property definitions of Pset\_Alignment**

Name	Type	Description
AlignWhich	TypePropertyEnumeratedValue/PEnum_AlignWhich:AlignCenterOfTrack,AlignCenterOfRailway	Indicates whether the alignment is the centerline of a single track or of a railway.
StandardForDesign	TypePropertySingleValue/IfcLabel	Standards observed in design.
AlignmentName	TypePropertySingleValue/IfcLabel	Alignment name.
Length	TypePropertySingleValue/IfcLengthMeasure	The whole length of an alignment.
MinimumRadiusOfCurve	TypePropertySingleValue/IfcLengthMeasure	The minimum radius of curves used in the alignment.
NumberOfCurve	TypePropertySingleValue/IfcNumber	Curve number in the alignment.
TotalLenghtOfCurves	TypePropertySingleValue/IfcLengthMeasure	Total length of all curves.
NumberOfSlope	TypePropertySingleValue/IfcNumber	The number of slope in the alignment
LiftingHeightForward	TypePropertySingleValue/IfcReal	Lifting height in the forward direction.
LiftingHeightBackword	TypePropertySingleValue/IfcReal	Lifting height in the backward direction.

## 6. Terrain Schema

Not available.

## 7. Geology Schema

### 7.1 Schema Definition

The data model structure of railway geology is composed of IfcGeologyPart and IfcGeologyElement.

IfcGeologyPart could be taken as the basic element of railway geology engineering.

IfcGeologyElement mainly contains IfcRockSoilMass, IfcDrillHole and IfcDrillHoleLayer.

Figure 7.1 shows the relationship between IfcGeologyPart and IfcGeologyElement.

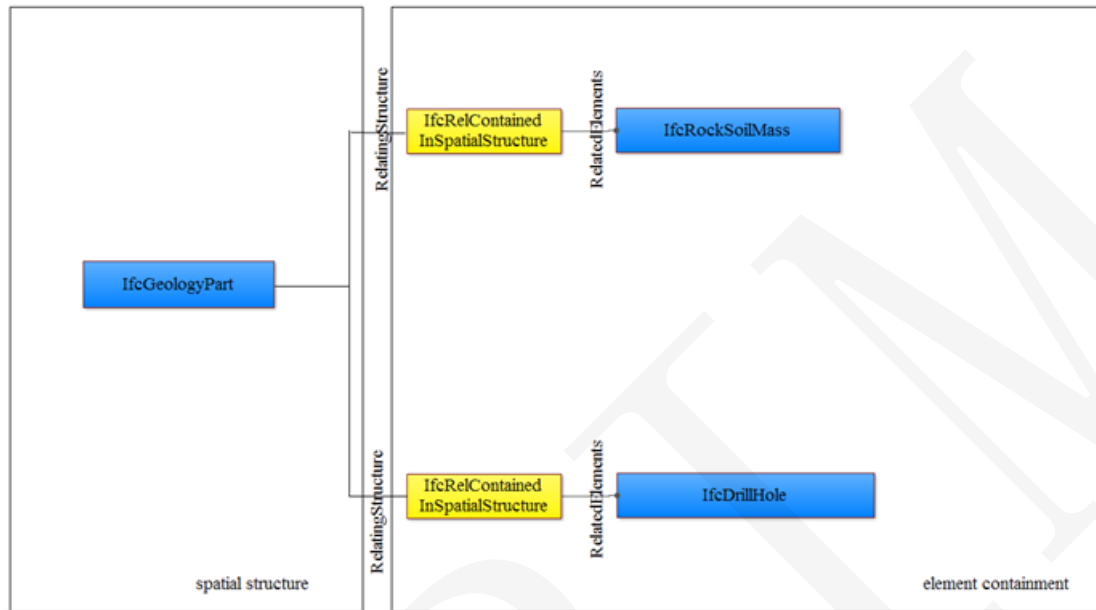

Figure 7.1 Geology composition

### 7.1.1 Spatial Structure Elements of Geology

IfcGeologyPart derived from IfcCivilStructureElement is the supertype of all the spatial structure elements in geology engineering. IfcGeologyPart can be divided into FORBRIDGE, FORSUBGRADE, FORTUNNEL and FORBUILDING by IfcGeologyPartTypeEnum. Figure 7.2 shows the inheritance relationship of IfcGeologyPart.

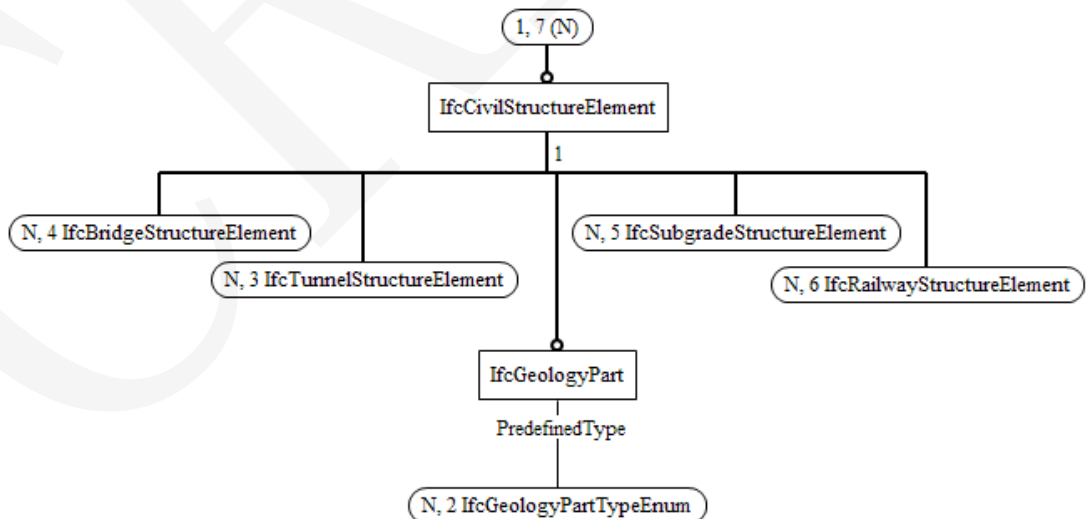
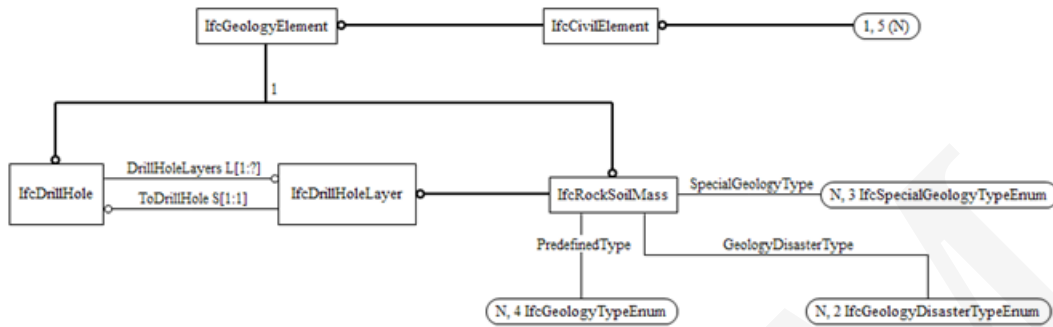

Figure 7.2 EXPRESS-G diagram for IfcGeologyPart

### 7.1.2 Physical Elements of Geology

Figure 7.3 shows the inheritance relationships of physical elements in geology engineering.



**Figure 7.3 EXPRESS-G diagram for physical elements of geology**

IfcGeologyElement is the supertype of all geology elements.

IfcRockSoilMass is the product of geological processes which can be distinguished by attribute and occupies a certain space. It is a basic element of a geology layer. IfcRockSoilMass can be divided into SOILAGGREGATE, SANDYSOIL, MUDDYSOIL, CLAYEDSOIL and ROCK by IfcGeologyTypeEnum. IfcRockSoilMass can be divided into GENERALGEOLOGY, COLLAPSIBLESOIL, EXPANSIVESOIL, FROST, REDCLAYEDSOIL, YIELDINGSOIL, MIXEDSOIL, BANKING, HALOMORPHICSOIL, RESIDUALSOIL and POLLUTIONSOIL by IfcSpecialGeologyTypeEnum. IfcRockSoilMass can be divided into GENERAL, LANDSLIDE, DEBRISFLOW, KARST, GOB, RADIOACTIVE, EARTHQUAKELIQ and SANDSTORM by IfcGeologyDisasterTypeEnum.

IfcDrillHole refers to a geological layer set in a certain radius and depth of the exploration point.

IfcDrillHoleLayer is derived from IfcRockSoilMass, which has accurate geological parameters.

## 7.2 Type Definition

### 7.2.1 IfcGeologyPartTypeEnum

This enumeration defines the different predefined types of geological sites.

#### Enumerated Item Definitions:

- FORBRIDGE;
- FORSUBGRADE;
- FORTUNNEL;
- FORBUILDING;
- USERDEFINED;
- NOTDEFINED.

#### EXPRESS Specification:



```
TYPE IfcGeologyPartTypeEnum= ENUMERATION OF
  (FORBRIDGE
  , FORSUBGRADE
  , FORTUNNEL
  , FORBUILDING
  , USERDEFINED
  , NOTDEFINED
);
END_TYPE;
```

### 7.2.2 IfcGeologyTypeEnum

This enumeration defines the different predefined types of geology.

#### **Enumerated Item Definitions:**

```
SOILAGGREGATE;
SANDYSOIL;
MUDDYSOIL;
CLAYEDSOIL;
ROCK;
USERDEFINED;
NOTDEFINED.
```

#### **EXPRESS Specification:**

```
TYPE IfcGeologyTypeEnum= ENUMERATION OF
  (SOILAGGREGATE
  , SANDYSOIL
  , MUDDYSOIL
  , CLAYEDSOIL
  , ROCK
  , USERDEFINED
  , NOTDEFINED
);
END_TYPE;
```

### 7.2.3 IfcSpecialGeologyTypeEnum

This enumeration defines the different types of special geology.

#### **Enumerated Item Definitions:**

```
GENERALGEOLOGY;
COLLAPSIBLESOIL;
EXPANSIVESOIL;
FROST;
REDCLAYEDSOIL;
```

YIELDINGSOIL;  
MIXEDSOIL;  
BANKING;  
HALOMORPHICSOIL;  
RESIDUALSOIL;  
POLLUTIONSOIL;  
USERDEFINED;  
NOTDEFINED.

**EXPRESS Specification:**

```
TYPE IfcSpecialGeologyTypeEnum= ENUMERATION OF  
  (GENERALGEOLOGY  
  , COLLAPSIBLESOIL  
  , EXPANSIVESOIL  
  , FROST  
  , REDCLAYEDSOIL  
  , YIELDINGSOIL  
  , MIXEDSOIL  
  , BANKING  
  , HALOMORPHICSOIL  
  ,RESIDUALSOIL  
  ,POLLUTIONSOIL  
  ,USERDEFINED  
  , NOTDEFINED  
);  
END_TYPE;
```

**7.2.4 IfcGeologyDisasterTypeEnum**

This enumeration defines the different types of geology disaster.

**Enumerated Item Definitions:**

GENERAL;  
LANDSLIDE;  
DEBRISFLOW;  
KARST;  
GOB;  
RADIOACTIVE;  
EARTHQUAKELIQ;  
SANDSTORM;  
USERDEFINED;  
NOTDEFINED.

**EXPRESS Specification:**

```

TYPE IfcGeologyDisasterTypeEnum= ENUMERATION OF
  (GENERAL
  ,LANDSLIDE
  ,DEBRISFLOW
  ,KARST
  ,GOB
  ,RADIOACTIVE
  ,EARTHQUAKELIQ
  ,SANDSTORM
  ,USERDEFINED
  ,NOTDEFINED
);
END_TYPE;

```

**7.3 Entity Definition**

**7.3.1 IfcGeologyPart**

IfcGeologyPart is a basic geological engineering unit.

**EXPRESS Specification:**

```

ENTITY IfcGeologyPart
  SUBTYPE OF (IfcCivilStructureElement);
  PredefinedType: IfcGeologyPartTypeEnum;
END_ENTITY;

```

**7.3.2 IfcGeologyElement**

IfcGeologyElement is the supertype of all the physical elements in geology engineering.

**EXPRESS Specification:**

```

ENTITY IfcGeologyElement
  SUPERTYPE OF (ONEOF (IfcRockSoilMass, IfcDrillHole));
  SUBTYPE OF (IfcCivilElement);
END_ENTITY;

```

**7.3.3 IfcRockSoilMass**

IfcRockSoilMass is defined as a basic element of a geological body. Some rock soil mass compose the geology of an area.

**Table 7.1 Property sets for IfcRockSoilMass**

PredefinedType	Name
	Pset_RockSoilMassCommon
	Pset_RockSoilMassProperty

**Table 7.2 Property sets for IfcRockSoilMass**

SpecialGeologyType	Name
--------------------	------

COLLAPSIBLESOIL	Pset_SpecialGeology_COLLAPSIBLESOI
EXPANSIVESOIL	Pset_SpecialGeology_EXPANSIVESOIL
FROST	Pset_SpecialGeology_FROST
HALOMORPHICSOIL	Pset_SpecialGeology_HALOMORPHICSOIL
POLLUTIONSOIL	Pset_SpecialGeology_POLLUTIONSOIL

**Table 7.3 Property sets for IfcRockSoilMass**

GeologyDisasterType	Name
LANDSLIDE	Pset_GeologyDisaster_LANDSLIDE
DEBRISFLOW	Pset_GeologyDisaster_DEBRISFLOW
KARST	Pset_GeologyDisaster_KARST
GOB	Pset_GeologyDisaster_GOB
RADIOACTIVE	Pset_GeologyDisaster_RADIOACTIVE
SANDSTORM	Pset_GeologyDisaster_SANDSTORM

**EXPRESS Specification:**

ENTITY IfcRockSoilMass

SUBTYPE OF (IfcGeologyElement);

PredefinedType: IfcGeologyTypeEnum;

SpecialGeologyType: IfcSpecialGeologyTypeEnum;

GeologyDisasterType: IfcGeologyDisasterTypeEnum;

END\_ENTITY;

**Attribute definitions:**

PreDefinedType: It contains Soilaggregate, Sandysoil, Muddysoil, Clayedsoil and Rock.

SpecialGeologyType: It contains General Geology, Collapsible Soil, Expansive Soil, Frost, Red Clayed Soil, Yielding Soil, Mixed Soil, Banking, Halomorphic Soil, Residual Soil and Pollution Soil.

GeologyDisasterType: It contains General, Landslide, Debris Flow, Karst, Gob, Radioactive, Earthquake Liquid and Sand Storm.

**7.3.4 IfcDrillHole**

IfcDrillHole is defined as a geological layer set in a certain radius and depth of the exploration point.

**Table 7.4 Property sets for IfcDrillHole**

PredefinedType	Name
	Pset_DrillHole

**EXPRESS Specification:**

ENTITY IfcDrillHole

SUBTYPE OF (IfcGeologyElement);

DrillHoleLayers: LIST [1:?] OF IfcDrillHoleLayer;

END\_ENTITY;

**7.3.5 IfcDrillHoleLayer**

IfcDrillHoleLayer is a geological layer in a certain radius and depth of the exploration point.

**Table 7.5 Property sets for IfcDrillHoleLayer**

PredefinedType	Name
	Pset_TestParameter

**EXPRESS Specification:**

ENTITY IfcDrillHoleLayer

SUBTYPE OF (IfcRockSoilMass);

INVERSE

ToDrillHole: SET [1:1] OF IfcDrillHole FOR DrillHoleLayers;

END\_ENTITY;

**7.4 Property Set Definition**

**7.4.1 Pset\_GeologyPart**

Name: Pset\_GeologyPart

Applicable Entities: IfcGeologyPart

Description: Common information of IfcGeologyPart.

Property Definitions: See Table 7.6.

**Table 7.6 Property definitions of Pset\_GeologyPart**

Name	Type	Description
GeologyPartName	TypePropertySingleValue/IfcLabel	Geology part name.
TerrainFeature	TypePropertySingleValue/IfcLabel	Terrain feature.
EngineerType	TypePropertySingleValue/IfcLabel	Engineer type.
Mileage	TypePropertySingleValue/IfcLabel	Mileage.
SiteClassification	TypePropertyEnumeratedValue/IfcLabel: Hard, Medium-hard, Medium-soft, Soft	Site classification.
PeakGroundAcceleration	TypePropertySingleValue/IfcAccelerationMeasure/m/s <sup>2</sup>	Peak ground acceleration.
MaximumFreezingDepth	TypePropertySingleValue/IfcLengthMeasure	Maximum freezing depth.

**7.4.2 Pset\_RockSoilMassCommon**

Name: Pset\_RockSoilMassCommon

Applicable Entities: IfcRockSoilMass

Description: Common information of IfcRockSoilMass.

Property Definitions: See Table 7.7.

**Table 7.7 Property definitions of Pset\_RockSoilMassCommon**

Name	Type	Description
GeotechnicalName	TypePropertySingleValue/IfcLabel	Geotechnical name.
BasicCapacity	TypePropertySingleValue/ IfcPressureMeasure /N/m <sup>2</sup>	Basic capacity.
OperationLevel	TypePropertyEnumeratedValue/IfcLabel: I , II ,III,IV, V ,VI	Operation level.
MainSubLayerNum	TypePropertySingleValue/IfcLabel	Main sublayer number.

AgeAndGenesis	TypePropertySingleValue/IfcLabel	Age and genesis.
---------------	----------------------------------	------------------

#### 7.4.3 Pset\_DrillHole

Name: Pset\_DrillHole

Applicable Entities: IfcDrillHole

Description: Common information of IfcDrillHole.

Property Definitions: See Table 7.8.

**Table 7.8 Property definitions of Pset\_DrillHole**

Name	Type	Description
HoleNum	TypePropertySingleValue/ IfcLabel	Hole number.
HoleTime	TypePropertySingleValue/ IfcTime	Hole time.
FirstLevel	TypePropertySingleValue/ IfcLengthMeasure	First level.
StandingLevel	TypePropertySingleValue/ IfcLengthMeasure	Standing level.
OrificeElevation	TypePropertySingleValue/ IfcLengthMeasure	Orifice elevation.
Depth	TypePropertySingleValue/ IfcLengthMeasure	Depth.

#### 7.4.4 Pset\_RockSoilMassProperty

Name: Pset\_RockSoilMassProperty

Applicable Entities: IfcRockSoilMass

Description: Property set of IfcRockSoilMass.

Property Definitions: See Table 7.9.

**Table 7.9 Property definitions of Pset\_RockSoilMassProperty**

Name	Type	Description
WeatheringDegree	TypePropertyEnumeratedValue/IfcLabel: Not weathered,Weak weathered,Moderate weathered,Intense weathered,Fully weathered	Weathering degree
Humidity	TypePropertyEnumeratedValue/IfcLabel: Slightly Wet,Wet, Saturated	Humidity
Compactness	TypePropertyEnumeratedValue/IfcLabel: Loose,Slightly dense,Medium dense,Dense	Compactness
PlasticState	TypePropertyEnumeratedValue/IfcLabel: Hard,Hard plasticity,Soft plasticity,Flow plasticity	Plastic state
RockType	TypePropertySingleValue/IfcLabel	Rock type

#### 7.4.5 Pset\_SpecialGeology\_COLLAPSIBLESOIL

Name: Pset\_SpecialGeology\_COLLAPSIBLESOIL

Applicable Entities: IfcRockSoilMass/COLLAPSIBLESOIL

Description: Property set of Collapsible Soil derived from IfcRockSoilMass.

Property Definitions: See Table 7.10.

**Table 7.10 Property definitions of Pset\_SpecialGeology\_COLLAPSIBLESOIL**

Name	Type	Description
CollapsibleLevel	TypePropertyEnumeratedValue/IfcLa	Collapsible level

	bel: I , II ,III,IV	
InitialCollapPressure	TypePropertySingleValue/IfcPressureMeasure	Initial collapsible pressure
CollapCoefficient	TypePropertySingleValue/IfcRatioMeasure	Collapsible coefficient
SelfWeightCollapCoefficient	TypePropertySingleValue/IfcRatioMeasure	SelfWeight collapsible coefficient

#### 7.4.6 Pset\_SpecialGeology\_EXPANSIVESOIL

Name: Pset\_SpecialGeology\_EXPANSIVESOIL

Applicable Entities: IfcRockSoilMass/EXPANSIVESOIL

Description: Property set of Expansive Soil derived from IfcRockSoilMass.

Property Definitions: See Table 7.11.

**Table 7.11 Property definitions of Pset\_SpecialGeology\_EXPANSIVESOIL**

Name	Type	Description
ExpansiveLevel	TypePropertyEnumeratedValue/IfcLabel:Weak,Medium,Hard	Expansive level
FreeSwellingRate	TypePropertySingleValue/IfcRatioMeasure	Free swelling rate
MontmorContent	TypePropertySingleValue/IfcRatioMeasure	Montmorillonite content
CationExchangeCapacity	TypePropertySingleValue/IfcLengthMeasure	Cation exchange capacity
Expansibility	TypePropertySingleValue/IfcPressureMeasure	Expansibility

#### 7.4.7 Pset\_SpecialGeology\_FROST

Name: Pset\_SpecialGeology\_FROST

Applicable Entities: IfcRockSoilMass/FROST

Description: Property set of Frost derived from IfcRockSoilMass.

Property Definitions: See Table 7.12.

**Table 7.12 Property definitions of Pset\_SpecialGeology\_FROST**

Name	Type	Description
ThawCollapLevel	TypePropertyEnumeratedValue/IfcLabel:I , II ,III,IV , V ,VI	Thaw collapse level

#### 7.4.8 Pset\_SpecialGeology\_HALOMORPHICSOIL

Name: Pset\_SpecialGeology\_HALOMORPHICSOIL

Applicable Entities: IfcRockSoilMass/HALOMORPHICSOIL

Description: Property set of Halomorphic Soil derived from IfcRockSoilMass.

Property Definitions: See Table 7.13.

**Table 7.13 Property definitions of Pset\_SpecialGeology\_HALOMORPHICSOIL**

Name	Type	Description
HalomoSoilDegree	TypePropertyEnumeratedValue/IfcLabel:	Halomorphic soil

	Weak,Medium,Hard,Super	degree
--	------------------------	--------

#### 7.4.9 Pset\_SpecialGeology\_POLLUTIONSOIL

Name: Pset\_SpecialGeology\_POLLUTIONSOIL

Applicable Entities: IfcRockSoilMass/ POLLUTIONSOIL

Description: Property set of Pollution Soil derived from IfcRockSoilMass.

Property Definitions: See Table 7.14.

**Table 7.14 Property definitions of Pset\_SpecialGeology\_POLLUTIONSOIL**

Name	Type	Description
ImpactLevel	TypePropertyEnumeratedValue/IfcLabel	Impact level.

#### 7.4.10 Pset\_GeologyDisaster\_LANDSLIDE

Name: Pset\_GeologyDisaster\_LANDSLIDE

Applicable Entities: IfcRockSoilMass/LANDSLIDE

Description: Property set of Landslide derived from IfcRockSoilMass.

Property Definitions: See Table 7.15.

**Table 7.15 Property definitions of Pset\_GeologyDisaster\_LANDSLIDE**

Name	Type	Description
LandslideScale	TypePropertyEnumeratedValue/IfcLabel: Small Scale, Medium Scale, Big Scale, Super Scale	Landslide scale.

#### 7.4.11 Pset\_GeologyDisaster\_DEBRISFLOW

Name: Pset\_GeologyDisaster\_DEBRISFLOW

Applicable Entities: IfcRockSoilMass/DEBRISFLOW

Description: Property set of debris flow derived from IfcRockSoilMass.

Property Definitions: See Table 7.16.

**Table 7.16 Property definitions of Pset\_GeologyDisaster\_DEBRISFLOW**

Name	Type	Description
DebrisFlowScale	TypePropertyEnumeratedValue/IfcLabel: Small Scale, Medium Scale, Big Scale, Super Scale	Debrisflow scale.

#### 7.4.12 Pset\_GeologyDisaster\_KARST

Name: Pset\_GeologyDisaster\_KARST

Applicable Entities: IfcRockSoilMass/KARST

Description: Property set of karst derived from IfcRockSoilMass.

Property Definitions: See Table 7.17.

**Table 7.17 Property definitions of Pset\_GeologyDisaster\_KARST**

Name	Type	Description
KarstLevel	TypePropertyEnumeratedValue/IfcLabel: Strong Development, Medium Development, Weak Development, Tiny Development	Karst level.

#### 7.4.13 Pset\_GeologyDisaster\_GOB

Name: Pset\_GeologyDisaster\_GOB



Applicable Entities: IfcRockSoilMass/GOB

Description: Property set of gob derived from IfcRockSoilMass.

Property Definitions: See Table 7.18.

**Table 7.18 Property definitions of Pset\_GeologyDisaster\_GOB**

Name	Type	Description
GobScale	TypePropertySingleValue/IfcAreaMeasure	Gob scale.

#### 7.4.14 Pset\_GeologyDisaster\_RADIOACTIVE

Name: Pset\_GeologyDisaster\_RADIOACTIVE

Applicable Entities: IfcRockSoilMass/RADIOACTIVE

Description: Property set of radioactive material derived from IfcRockSoilMass.

Property Definitions: See Table 7.19.

**Table 7.19 Property definitions of Pset\_GeologyDisaster\_RADIOACTIVE**

Name	Type	Description
RadioactiveType	TypePropertyEnumeratedValue/IfcLabel	Radioactive type.

#### 7.4.15 Pset\_GeologyDisaster\_SANDSTORM

Name: Pset\_GeologyDisaster\_SANDSTORM

Applicable Entities: IfcRockSoilMass/SANDSTORM

Description: Property set of sand storm derived from IfcRockSoilMass.

Property Definitions: See Table 7.20.

**Table 7.20 Property definitions of Pset\_GeologyDisaster\_SANDSTORM**

Name	Type	Description
SandStormDegree	TypePropertyEnumeratedValue/IfcLabel: Strong, Medium, Weak	Sandstorm degree.

#### 7.4.16 Pset\_TestParameter

Name: Pset\_TestParameter

Applicable Entities: IfcDrillHoleLayer

Description: Property set of rock soil test derived from IfcDrillHoleLayer.

Property Definitions: See Table 7.21.

**Table 7.21 Property definitions of Pset\_TestParameter**

Name	Type	Description
WaterRatio	TypePropertySingleValue/IfcRatioMeasure	Water ratio
Density	TypePropertySingleValue/IfcMassDensityMeasure	Density
GrainDensity	TypePropertySingleValue/IfcMassDensityMeasure	Grain density
VoidRatio	TypePropertySingleValue/ IfcRatioMeasure	Void ratio
Saturation	TypePropertySingleValue/IfcRatioMeasure	Saturation
LiqBoundary	TypePropertySingleValue/IfcRatioMeasure	Liquid boundary
PlaBoundary	TypePropertySingleValue/IfcRatioMeasure	Plastic boundary
LiqIndex	TypePropertySingleValue/IfcRatioMeasure	Liquid index

PlaIndex	TypePropertySingle Value/IfcRatioMeasure	Plastic index
CompreCoefficient	TypePropertySingle Value/IfcLengthMeasure	Coefficient of compressibility
PreModulus	TypePropertySingle Value/IfcPressureMeasure	Compression modulus
InterFricAngle	TypePropertySingle Value/ IfcPlaneAngleMeasure	Interfriction Angle
Cohesion	TypePropertySingle Value/ IfcPressureMeasure	Cohesion
AntiPressStren	TypePropertySingle Value/ IfcPressureMeasure	Anti press strength

## 8. Subgrade Schema

### 8.1 Schema Definition

The data model architecture of railway subgrade is composed of IfcSubgradeStructureElement, IfcSubgradeElementAssembly and IfcSubgradeElement.

IfcSubgradeStructureElement mainly includes IfcSubgradeStructurePartElement, IfcSubgradeSlopeProtectionElement, IfcSubgradeRetainingStructureElement, IfcSubgradeSubsoilTreatmentElement and IfcSubgradeTransitionSectionStructureElement.

IfcSubgradeElementAssembly mainly includes IfcSubgradeRetainingStructureSectionAssembly and IfcSubgradeSubsoilReinforcementPileAssembly.

IfcSubgradeElement mainly includes IfcSubgradeRetainingElement, IfcSubgradeFillingWorks, IfcSubgradeSlopeProtectionSectionElement, IfcSubgradeSubsoilReinforcementPileElement, IfcOriginalSubgradeSubsoilReinforcement and IfcSubgradeTransitionSectionElement.

Figure 8.1 shows the relationship between IfcSubgradeStructureElement, IfcSubgradeElementAssembly and IfcSubgradeElement.

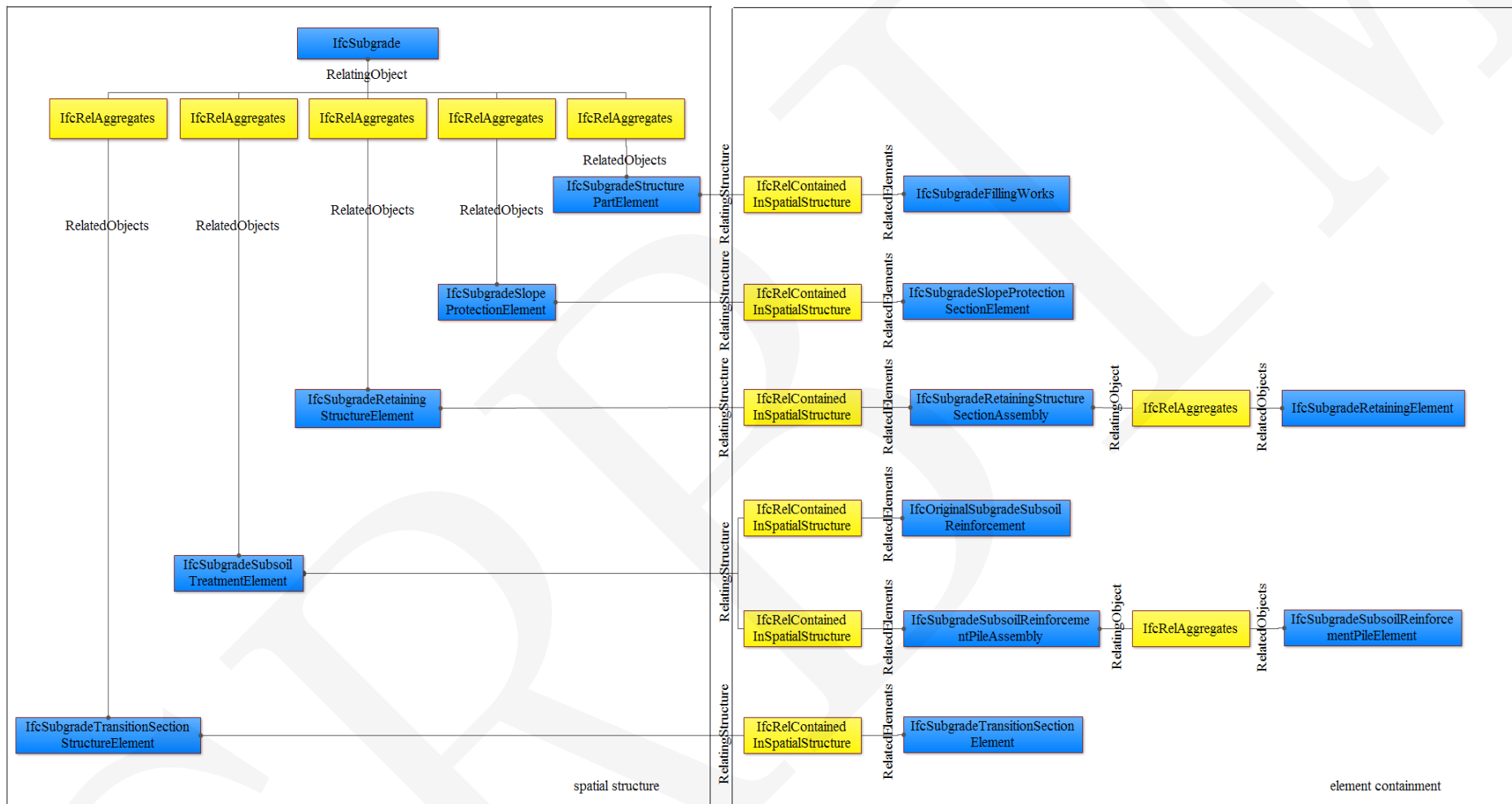

**Figure 8.1 Relationship between IfcSubgradeStructureElement, IfcSubgradeElementAssembly and IfcSubgradeElement**

### 8.1.1 Spatial Structure Elements of Subgrade

IfcCivilStructureElement is defined in IFC4. IfcSubgradeStructureElement derived from IfcCivilStructureElement is the supertype of all the spatial structure elements in subgrade engineering. IfcSubgradeStructureElement further derives IfcSubgrade, IfcSubgradeStructurePartElement, IfcSubgradeSlopeProtectionElement, IfcSubgradeRetainingStructureElement, IfcSubgradeSubsoilTreatmentElement and IfcSubgradeTransitionSectionStructureElement. Figure 8.2 shows the inheritance relationship between all the spatial structure elements in subgrade engineering.

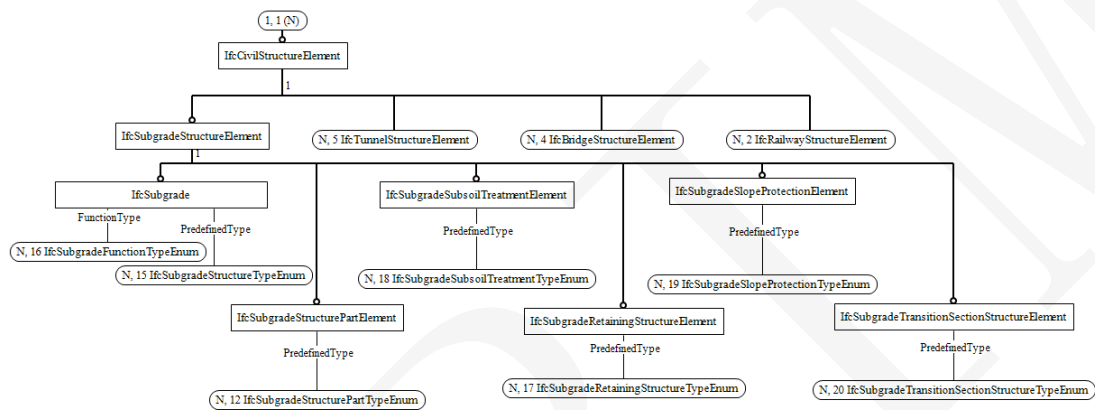

**Figure 8.2 EXPRESS-G diagram for spatial structure elements in subgrade engineering**

IfcSubgradeStructureElement is the supertype of all the spatial structure elements in subgrade engineering.

IfcSubgrade defines a segment of subgrade, or a work site for subgrade. IfcSubgrade can be further decomposed into IfcSubgradeStructurePartElement, IfcSubgradeSlopeProtectionElement, IfcSubgradeSubsoilTreatmentElement, IfcSubgradeRetainingStructureElement and IfcSubgradeTransitionSectionStructureElement from the perspective of spatial structure. IfcSubgrade can be decomposed into EMBANKMENT, CUTTING and CUTANDFILLSUBGRADE by predefined types. IfcSubgrade can be decomposed into RAILWAYSUBGRADE, HIGHWAYSUBGRADE and ROADSUBGRADE by functional types.

IfcSubgradeStructurePartElement defines the main body of subgrade structure. An IfcSubgradeStructurePartElement is composed of one or more IfcSubgradeFillingWorks. An IfcSubgrade may contain one or more IfcSubgradeStructurePartElement.

IfcSubgradeSlopeProtectionElement is used to define block-based subgrade slope protection. An IfcSubgrade may contain one or more IfcSubgradeSlopeProtectionElement objects. Generally speaking, the slope protection measures on both sides of the subgrade may be defined as two IfcSubgradeSlopeProtectionElement objects. An IfcSubgradeSlopeProtectionElement is composed of one or more IfcSubgradeSlopeProtectionSectionElement objects.

IfcSubgradeSubsoilTreatmentElement is used to define block-based subgrade subsoil treatment. An IfcSubgrade usually contains an IfcSubgradeSubsoilTreatmentElement. An IfcSubgradeSubsoilTreatmentElement is composed of one or more IfcSubgradeSubsoilReinforcementPileAssembly or IfcOriginalSubgradeSubsoilReinforcement objects.

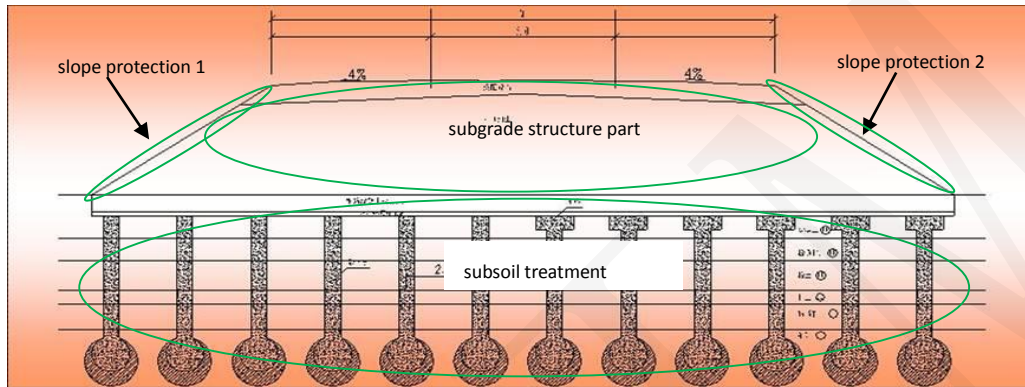

**Figure 8.3 Subgrade cross section and relevant structures**

IfcSubgradeRetainingStructureElement is used to define the retaining structures in subgrade engineering, such as gravity retaining wall, balance weight retaining wall and cantilever retaining wall. An IfcSubgradeRetainingStructureElement is composed of one or more IfcSubgradeRetainingStructureSectionAssembly objects. In Figure 8.4 (a), the section between two expansion joints is a reinforced earth retaining wall section. Some reinforced earth retaining wall sections compose the reinforced earth retaining wall. In Figure 8.4 (b), section ① and section ② are anchorage pile and retaining plate in IfcSubgradeRetainingElement. The combination of section ① and section ② is reinforced concrete retaining wall section assembly. Some reinforced concrete retaining wall section assembly objects compose reinforced concrete retaining wall.



(a) Reinforced earth retaining wall (b) reinforced concrete retaining wall

**Figure 8.4 Retaining structure**

IfcSubgradeTransitionSectionStructureElement is used to define the section requiring special treatment to connect the subgrade and structures, which is composed of IfcSubgradeTransitionSectionElement objects. In Figure 8.5, the "Graded crushed stone mixed with

3% cement" section indicates a transition cone. The transition cone in vertical-section is a subgrade transition section, whose length is  $L$  in Figure 8.5.

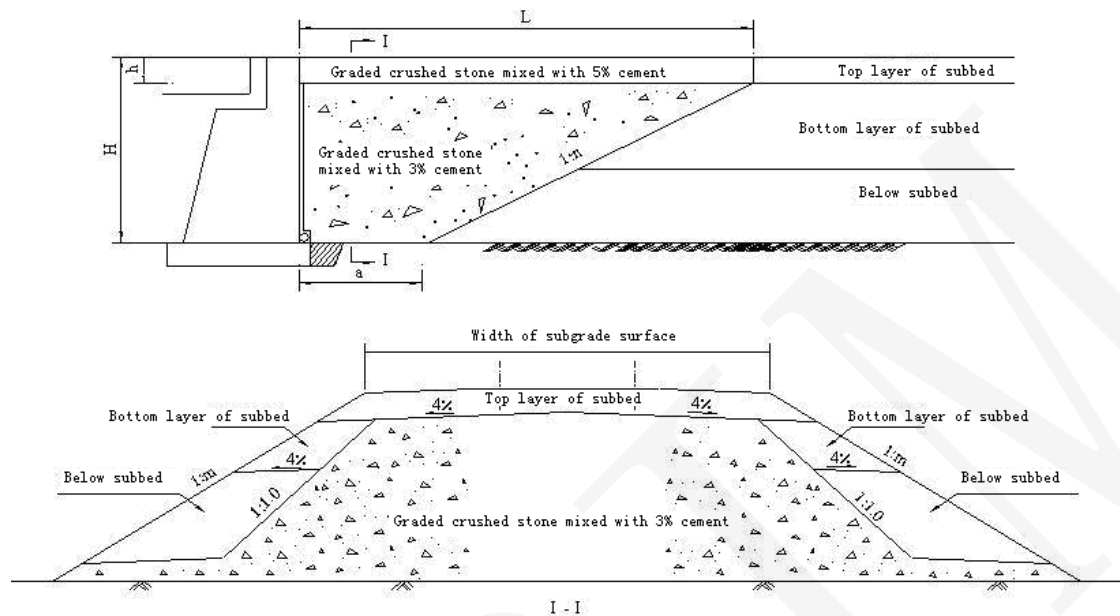

Figure 8.5 Subgrade transition section

### 8.1.2 Physical Elements of Subgrade

Figure 8.6 shows the EXPRESS-G diagram for physical elements in subgrade engineering.

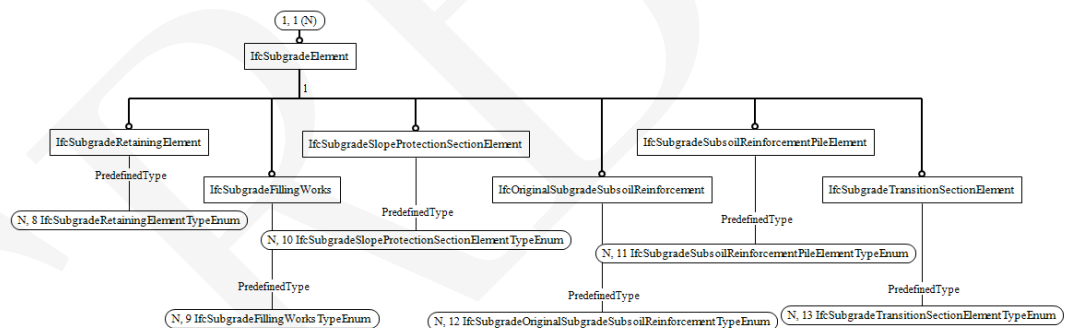

Figure 8.6 EXPRESS-G diagram for physical elements of subgrade

IfcSubgradeElement is the supertype of all the physical elements in subgrade engineering.

IfcSubgradeRetainingElement refers to the basic elements of subgrade retaining structure, containing GRARETBODY, BALWEIRETBODY, CANRETBODY, COURETBODY, ANCHORAGEPILE, RETAININGPLATE, RIBBEDCOLUMN, PANEL, REIEARRETBODY, WALLFOUNDATION, PRECABLEBODY, PILEFOUNTRIMMER, DOCKRETBODY, SHORTRELRETBODY, WINDBREAKBODY, SOILNAILRATBODY, ANCHORPLATE, ANCHORPLATEPULLROD, WALLPANEL, ANCHRIBCOLUMN, and so on.

IfcSubgradeFillingWorks refers to the components of subgrade filling, including TOPLAYERSUBBED, BOTTOMLAYERSUBBED, BELOWSUBBED and REPSUBBASE.

IfcSubgradeSlopeProtectionSectionElement refers to the basic elements of subgrade slope protection. Subgrade slope protection is usually composed of several IfcSubgradeSlopeProtectionSectionElements. IfcSubgradeSlopeProtectionSectionElement includes ARCHEDFRAMEWORK, HOLETYPEPROWALL, MORTARRUBBLE, ANCHOREDFRAMEBEAM, GRIDFRAME, DIOMONDFRAME, HUMANSHAPEDFRAME, HOLLOWBRICK, SOLIDSLOPEPROTECTION, and so on.

IfcSubgradeSubsoilReinforcementPileElement refers to the pile elements to improve the bearing capacity of foundation composed of soil or rock. IfcSubgradeSubsoilReinforcementPileElement includes PILEBODY and PILECAP.

IfcOriginalSubgradeSubsoilReinforcement refers to the engineer measures to improve the bearing capacity of foundation, such as COMPACTION, RAMMED, GROUTING, SANDWICK and SHEETDRAIN.

IfcSubgradeTransitionSectionElement refers to the basic elements of subgrade transition section, including TRANSITIONCONE, FOUNDATIONBACKFILLINGSOIL, NONSANDCONPERPLATE and REPLACEMENTSOIL.

### 8.1.3 Element Assemblies of Subgrade

Figure 8.7 shows the EXPRESS-G diagram for element assemblies in subgrade engineering.

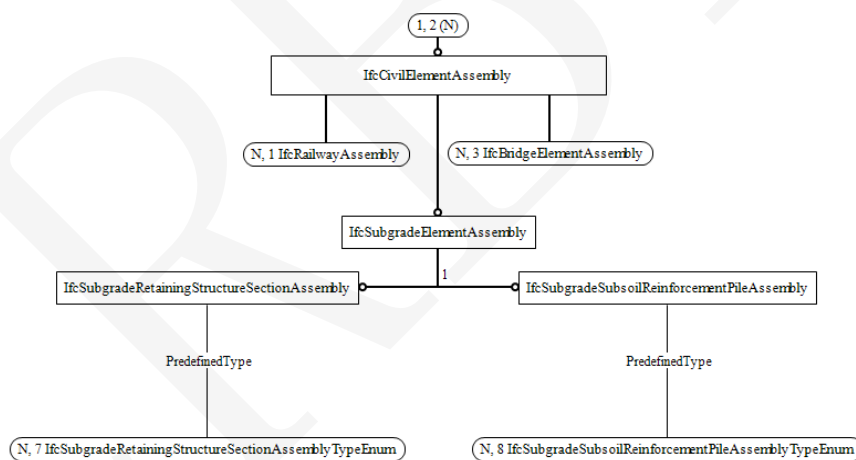

Figure 8.7 EXPRESS-G diagram for IfcSubgradeElementAssembly

IfcSubgradeElementAssembly is the supertype of all the element assemblies in subgrade engineering.

IfcSubgradeRetainingStructureSectionAssembly is composed of IfcSubgradeRetainingElement. Generally, IfcSubgradeRetainingStructureSectionAssembly is a retaining wall section with expansion joint as the dividing line.

IfcSubgradeSubsoilReinforcementPileAssembly refers to a single pile composed of IfcSubgradeSubsoilReinforcementPileElement.

## 8.2 Type Definition

### 8.2.1 IfcSubgradeStructureTypeEnum

This enumeration defines the different predefined types of subgrade from the perspective of form.

#### Enumerated Item Definitions:

EMBANKMENT;  
CUTTING;  
CUTANDFILLSUBGRADE;  
USERDEFINED;  
NOTDEFINED.

#### EXPRESS Specification:

```
TYPE IfcSubgradeStructureTypeEnum = ENUMERATION OF  
  (EMBANKMENT  
  , CUTTING  
  , CUTANDFILLSUBGRADE  
  , USERDEFINED  
  , NOTDEFINED  
);  
END_TYPE;
```

### 8.2.2 IfcSubgradeFunctionTypeEnum

This enumeration defines the different functional types of subgrade.

#### Enumerated Item Definitions:

RAILWAYSUBGRADE;  
HIGHWAYSUBGRADE;  
ROADSUBGRADE;  
USERDEFINED;  
NOTDEFINED.

#### EXPRESS Specification:

```
TYPE IfcSubgradeFunctionTypeEnum = ENUMERATION OF  
  (RAILWAYSUBGRADE  
  , HIGHWAYSUBGRADE  
  , ROADSUBGRADE  
  , USERDEFINED  
  , NOTDEFINED  
);  
END_TYPE;
```

### 8.2.3 IfcSubgradeStructurePartTypeEnum



This enumeration defines the different predefined types of an IfcSubgradeStructurePartElement.

**Enumerated Item Definitions:**

USERDEFINED;  
NOTDEFINED.

**EXPRESS Specification:**

```
TYPE IfcSubgradeStructurePartTypeEnum = ENUMERATION OF  
  ( USERDEFINED  
    , NOTDEFINED  
  );  
END_TYPE;
```

#### 8.2.4 IfcSubgradeSlopeProtectionTypeEnum

This enumeration defines the different predefined types of an IfcSubgradeSlopeProtectionElement.

**Enumerated Item Definitions:**

USERDEFINED;  
NOTDEFINED.

**EXPRESS Specification:**

```
TYPE IfcSubgradeSlopeProtectionTypeEnum = ENUMERATION OF  
  ( USERDEFINED  
    , NOTDEFINED  
  );  
END_TYPE;
```

#### 8.2.5 IfcSubgradeRetainingStructureTypeEnum

This enumeration defines the different predefined types of an IfcSubgradeRetainingStructureElement.

**Enumerated Item Definitions:**

GRARETWALL;  
BALWEIRETWALL;  
CANRETWALL;  
COURETWALL;  
REICONRETWALL;  
ANCBOLTRETWALL;  
REIEARRETWALL;  
PRECABLE;

PILEFOUNRETWALL;  
DOCKRETWALL;  
SHORTRELRETWALL;  
WINDBREAKWALL;  
SOILNAILRATWALL;  
ANCPLARETWALL;  
USERDEFINED;  
NOTDEFINED.

**EXPRESS Specification:**

```
TYPE IfcSubgradeRetainingStructureTypeEnum = ENUMERATION OF  
  (GRARETWALL  
  ,BALWEIRETWALL  
  ,CANRETWALL  
  ,COURETWALL  
  ,REICONRETWALL  
  ,ANCBOLTRETWALL  
  ,REIEARRETWALL  
  ,PRECABLE  
  ,PILEFOUNRETWALL  
  ,DOCKRETWALL  
  ,SHORTRELRETWALL  
  ,WINDBREAKWALL  
  ,SOILNAILRATWALL  
  ,ANCPLARETWALL  
  ,USERDEFINED  
  ,NOTDEFINED  
  );  
END_TYPE;
```

**8.2.6 IfcSubgradeSubsoilTreatmentTypeEnum**

This enumeration defines the different predefined types of an IfcSubgradeSubsoilTreatmentElement.

**Enumerated Item Definitions:**

USERDEFINED;  
NOTDEFINED.

**EXPRESS Specification:**

```
TYPE IfcSubgradeSubsoilTreatmentTypeEnum = ENUMERATION OF  
  ( USERDEFINED  
  , NOTDEFINED
```

```
);  
END_TYPE;
```

### 8.2.7 IfcSubgradeTransitionSectionStructureTypeEnum

This enumeration defines the different predefined types of an IfcSubgradeTransitionSectionStructureElement.

#### Enumerated Item Definitions:

```
EMBANKMENTABUTMENT;  
MBANKMENTLATERALSTRUCTURE; EMBANKMENTCUTTING;  
CUTTINGABUTMENT;  
CUTTINGTUNNEL;  
USERDEFINED;  
NOTDEFINED.
```

#### EXPRESS Specification:

```
TYPE IfcSubgradeTransitionSectionStructureTypeEnum = ENUMERATION OF  
  (EMBANKMENTABUTMENT  
  , EMBANKMENTLATERALSTRUCTURE  
  , EMBANKMENTCUTTING  
  , CUTTINGABUTMENT  
  , CUTTINGTUNNEL  
  , USERDEFINED  
  , NOTDEFINED  
);  
END_TYPE;
```

### 8.2.8 IfcSubgradeRetainingElementTypeEnum

This enumeration defines the different predefined types of an IfcSubgradeRetainingElement.

#### Enumerated Item Definitions:

```
GRARETBODY;  
BALWEIRETBODY;  
CANRETBODY;  
COURETBODY;  
ANCHORAGEPILE;  
RETAININGPLATE;  
RIBBEDCOLUMN;  
PANEL;  
REIEARRETBODY;  
WALLFOUNDATION;  
PRECABLEBODY;
```

PILEFOUNTRIMMER;  
DOCKRETBODY;  
SHORTRELRETBODY;  
WINDBREAKBODY;  
SOILNAILRATBODY;  
ANCHORPLATE;  
ANCHORPLATEPULLROD;  
WALLPANEL;  
ANCHRIBCOLUMN;  
USERDEFINED;  
NOTDEFINED.

**EXPRESS Specification:**

TYPE IfcSubgradeRetainingElementTypeEnum = ENUMERATION OF

(GRARETBODY  
,BALWEIRETBODY  
,CANRETBODY  
,COURETBODY  
,ANCHORAGEPILE  
,RETAININGPLATE  
,RIBBEDCOLUMN  
,PANEL  
,REIEARRETBODY  
,WALLFOUNDATION  
,PRECABLEBODY  
,PILEFOUNTRIMMER  
,DOCKRETBODY  
,SHORTRELRETBODY  
,WINDBREAKBODY  
,SOILNAILRATBODY  
,ANCHORPLATE  
,ANCHORPLATEPULLROD  
,WALLPANEL  
,ANCHRIBCOLUMN  
,USERDEFINED  
, NOTDEFINED

);

END\_TYPE;

**8.2.9 IfcSubgradeFillingWorksTypeEnum**

This enumeration defines the different predefined types of an IfcSubgradeFillingWorks.

**Enumerated Item Definitions:**

TOPLAYERSUBBED;  
BOTTOMLAYERSUBBED;  
BELOWSUBBED;  
REPSUBBASE;  
USERDEFINED;  
NOTDEFINED.

**EXPRESS Specification:**

```
TYPE IfcSubgradeFillingWorksTypeEnum = ENUMERATION OF  
  (TOPLAYERSUBBED  
  ,BOTTOMLAYERSUBBED  
  ,BELOWSUBBED  
  ,REPSUBBASE  
  ,USERDEFINED  
  , NOTDEFINED  
  );  
END_TYPE;
```

**8.2.10 IfcSubgradeSlopeProtectionSectionElementTypeEnum**

This enumeration defines the different predefined types of an IfcSubgradeSlopeProtectionSectionElement.

**Enumerated Item Definitions:**

ARCHEDFRAMEWORK;  
HOLETYPPEPROWALL;  
MORTARRUBBLE;  
ANCHOREDFRAMEBEAM;  
GRIDFRAME;  
DIOMONDFRAME;  
HUMANSHAPEDFRAME;  
HOLLOWBRICK;  
SOLIDSLOPEPROTECTION;;  
USERDEFINED;  
NOTDEFINED.

**EXPRESS Specification:**

```
TYPE IfcSubgradeSlopeProtectionSectionElementTypeEnum = ENUMERATION OF  
  (ARCHEDFRAMEWORK  
  ,HOLETYPPEPROWALL
```

```

        ,MORTARRUBBLE
        ,ANCHOREDFRAMEBEAM
        ,GRIDFRAME
        ,DIOMONDFRAME
        ,HUMANSHAPEDFRAME
        ,HOLLOWBRICK
        ,SOLIDSLOPEPROTECTION
        ,USERDEFINED
        ,NOTDEFINED
    );
    END_TYPE;

```

### 8.2.11 IfcSubgradeSubsoilReinforcementPileElementTypeEnum

This enumeration defines the different predefined types of an IfcSubgradeSubsoilReinforcementPileElement.

#### Enumerated Item Definitions:

```

PILECAP;
PILEBODY;
USERDEFINED;
NOTDEFINED.

```

#### EXPRESS Specification:

```

TYPE IfcSubgradeSubsoilReinforcementPileElementTypeEnum = ENUMERATION OF
    (PILECAP
    ,PILEBODY
    ,USERDEFINED
    , NOTDEFINED
    );
    END_TYPE;

```

### 8.2.12 IfcSubgradeOriginalSubgradeSubsoilReinforcementTypeEnum

This enumeration defines the different predefined types of an IfcSubgradeOriginalSubgradeSubsoilReinforcement.

#### Enumerated Item Definitions:

```

COMPACTION;
RAMMED;
GROUTING;
SANDWICK;
SHEETDRAIN;
USERDEFINED;
NOTDEFINED.

```

**EXPRESS Specification:**

```
TYPE IfcSubgradeOriginalSubgradeSubsoilReinforcementTypeEnum = ENUMERATION OF  
  (COMPACTION  
  ,RAMMED  
  ,GROUTING  
  ,SANDWICK  
  ,SHEETDRAIN  
  ,USERDEFINED  
  , NOTDEFINED  
  );  
END_TYPE;
```

**8.2.13 IfcSubgradeTransitionSectionElementTypeEnum**

This enumeration defines the different predefined types of an IfcSubgradeTransitionSectionElement.

**Enumerated Item Definitions:**

```
TRANSITIONCONE;  
FOUNDATIONBACKFILLINGSOIL;  
NONSANDCONPERPLATE;  
REPLACEMENTSOIL;  
USERDEFINED;  
NOTDEFINED.
```

**EXPRESS Specification:**

```
TYPE IfcSubgradeTransitionSectionElementTypeEnum= ENUMERATION OF  
  (TRANSITIONCONE  
  ,FOUNDATIONBACKFILLINGSOIL  
  ,NONSANDCONPERPLATE  
  ,REPLACEMENTSOIL  
  ,USERDEFINED  
  , NOTDEFINED  
  );  
END_TYPE;
```

**8.2.14 IfcSubgradeRetainingStructureSectionAssemblyTypeEnum**

This enumeration defines the different predefined types of an IfcSubgradeRetainingStructureSectionAssembly.

**Enumerated Item Definitions:**

```
GRARETSECTION;  
BALWEIRETSECTION;
```

CANRETSECTION;  
COURETSECTION;  
REICONRETSECTION;  
ANCBOLTRETSECTION;  
REIEARRETSECTION;  
PRECABLESECTION;  
PILEFOUNRETSECTION;  
DOCKRETSECTION;  
SHORTRELRETSECTION;  
WINDBREAKSECTION;  
SOILNAILRATSECTION;  
ANCPLARETSECTION;  
USERDEFINED;  
NOTDEFINED.

**EXPRESS Specification:**

TYPE IfcSubgradeRetainingStructureSectionAssemblyTypeEnum= ENUMERATION OF

(GRARETSECTION  
,BALWEIRETSECTION  
,CANRETSECTION  
,COURETSECTION  
,REICONRETSECTION  
,ANCBOLTRETSECTION  
,REIEARRETSECTION  
,PRECABLESECTION  
,PILEFOUNRETSECTION  
,DOCKRETSECTION  
,SHORTRELRETSECTION  
,WINDBREAKSECTION  
,SOILNAILRATSECTION  
,ANCPLARETSECTION  
,USERDEFINED  
,NOTDEFINED

);  
END\_TYPE;

**8.2.15 IfcSubgradeSubsoilReinforcementPileAssemblyTypeEnum**

This enumeration defines the different predefined types of an IfcSubgradeSubsoilReinforcementPileAssembly.

**Enumerated Item Definitions:**



CEMENTMIXINGPILE;  
 LIMESOILCOMPILE;  
 CEMFLYGRAPILE;  
 CHEMICALCHURNINGPILE;  
 COLUMNHAMEXPPILE;  
 CEMSOILCOMPPILE;  
 USERDEFINED;  
 NOTDEFINED.

**EXPRESS Specification:**

```
TYPE IfcSubgradeSubsoilReinforcementPileAssemblyTypeEnum= ENUMERATION OF
  (CEMENTMIXINGPILE
  ,LIMESOILCOMPILE
  ,CEMFLYGRAPILE
  ,CHEMICALCHURNINGPILE
  ,COLUMNHAMEXPPILE
  ,CEMSOILCOMPPILE
  ,USERDEFINED
  ,NOTDEFINED
);
END_TYPE;
```

**8.3 Entity Definition**

**8.3.1 IfcSubgradeStructureElement**

IfcSubgradeStructureElement is the supertype of all the spatial structure elements in subgrade engineering.

**EXPRESS Specification:**

```
ENTITY IfcSubgradeStructureElement
  SUPERTYPE OF (ONEOF
    (IfcSubgrade,IfcSubgradeStructurePartElement,IfcSubgradeSlopeProtectionElement,IfcSubgradeRetain
    ingStructureElement,IfcSubgradeSubsoilTreatmentElement,IfcSubgradeTransitionSectionStructureElement)
  SUBTYPE OF (IfcCivilStructureElement);
END_ENTITY;
```

**8.3.2 IfcSubgrade**

IfcSubgrade refers to a segment of subgrade with certain functions, clear start point and end point.

**Table 8.1 IfcSubgrade spatial composition**

Spatial Composite	Description
IfcRailway	IfcSubgrade can be a component of IfcRailway.
IfcRailwayStation	IfcSubgrade can be a component of IfcRailwayStation.

**Table 8.2 IfcSubgrade spatial decomposition**

<b>Spatial Parts</b>	<b>Description</b>
IfcSubgradeStructurePartElement	IfcSubgradeStructurePartElement is a component of IfcSubgrade.
IfcSubgradeSlopeProtectionElement	IfcSubgradeSlopeProtectionElement is a component of IfcSubgrade.
IfcSubgradeRetainingStructureElement	IfcSubgradeRetainingStructureElement is a component of IfcSubgrade.
IfcSubgradeSubsoilTreatmentElement	IfcSubgradeSubsoilTreatmentElement is a component of IfcSubgrade.
IfcSubgradeTransitionSectionStructureElement	IfcSubgradeTransitionSectionStructureElement is a component of IfcSubgrade.

**EXPRESS Specification:**

```

ENTITY IfcSubgrade
  SUBTYPE OF (IfcSubgradeStructureElement);
    PredefinedType: IfcSubgradeStructureTypeEnum;
    FunctionType: IfcSubgradeFunctionTypeEnum;
END_ENTITY;

```

**Attribute definitions:**

PreDefinedType: IfcSubgrade is structurally decomposed into EMBANKMENT, CUTTING and CUTANDFILLSUBGRADE.

FunctionType: To define different function types of subgrade, such as RAILWAYSUBGRADE, HIGHWAYSUBGRADE and ROADSUBGRADE.

**8.3.3 IfcSubgradeStructurePartElement**

IfcSubgradeStructurePartElement is used to define the main body of subgrade. An IfcSubgradeStructurePartElement is composed of one or more IfcSubgradeFillingWorks. An IfcSubgrade may contain one or more IfcSubgradeStructurePartElement objects.

**Table 8.3 Property sets for IfcSubgradeStructurePartElement**

<b>PredefinedType</b>	<b>Name</b>
	Pset_SubgradeStructurePartElementCommon

**Table 8.4 IfcSubgradeStructurePartElement spatial composition**

<b>Spatial Composite</b>	<b>Description</b>
IfcSubgrade	AIfcSubgradeStructurePartElement is a component of IfcSubgrade.

**Table 8.5 IfcSubgradeStructurePartElement spatial containment**

<b>PredefinedType</b>	<b>Contained Entities</b>	<b>Description</b>
	IfcSubgradeFillingWorks	IfcSubgradeFillingWorks can be contained in IfcSubgradeStructurePartElement.

**EXPRESS Specification:**

ENTITY IfcSubgradeStructurePartElement  
 SUBTYPE OF (IfcSubgradeStructureElement);  
 PredefinedType: IfcSubgradeStructurePartTypeEnum;  
 END\_ENTITY;

**Attribute definitions:**

PreDefinedType.

**8.3.4 IfcSubgradeSlopeProtectionElement**

IfcSubgradeSlopeProtectionElement is used to define block-based subgrade slope protection. An IfcSubgrade may be composed of one or more IfcSubgradeSlopeProtectionElement objects. Generally speaking, the slope protection measures on both sides of the subgrade are defined as two IfcSubgradeSlopeProtectionElement objects. An IfcSubgradeSlopeProtectionElement is composed of one or more IfcSubgradeSlopeProtectionSectionElement objects.

**Table 8.6 Property sets for IfcSubgradeSlopeProtectionElement**

PredefinedType	Name
	Pset_SubgradeSlopeProtectionElementCommon

**Table 8.7 IfcSubgradeSlopeProtectionElement spatial composition**

Spatial Composite	Description
IfcSubgrade	IfcSubgradeSlopeProtectionElement is a component of IfcSubgrade.

**Table 8.8 IfcSubgradeSlopeProtectionElement spatial containment**

PredefinedType	Contained Entities	Description
	IfcSubgradeSlopeProtectionSectionElement	IfcSubgradeSlopeProtectionElement may contain IfcSubgradeSlopeProtectionSectionElement.

**EXPRESS Specification:**

ENTITY IfcSubgradeSlopeProtectionElement  
 SUBTYPE OF (IfcSubgradeStructureElement);  
 PredefinedType: IfcSubgradeSlopeProtectionTypeEnum;  
 END\_ENTITY;

**Attribute definitions:**

PreDefinedType.

**8.3.5 IfcSubgradeRetainingStructureElement**

IfcSubgradeRetainingStructureElement is used to define subgrade retaining structures, such as gravity retaining wall, balance weight retaining wall and cantilever retaining wall. An IfcSubgradeRetainingStructureElement is composed of one or more IfcSubgradeRetainingStructureSectionAssembly objects.

**Table 8.9 Property sets for IfcSubgradeRetainingStructureElement**

PredefinedType	Name
----------------	------

	Pset_SubgradeRetainingStructureElementCommon
REICONRETWALL	Pset_REICONRETWALL
ANCBOLTRETWALL	Pset_ANCBOLTRETWALL

**Table 8.10 IfcSubgradeRetainingStructureElement spatial composition**

<b>Spatial Composite</b>	<b>Description</b>
IfcSubgrade	IfcSubgradeRetainingStructureElement is a component of IfcSubgrade.

**Table 8.11 IfcSubgradeRetainingStructureElement spatial containment**

<b>PredefinedType</b>	<b>Contained Entities</b>	<b>Description</b>
GRARETWALL	IfcSubgradeRetainingStructureSection Assembly/GRARETSECTION	Gravity retaining wall may contain gravity retaining wall section.
BALWEIRETWALL	IfcSubgradeRetainingStructureSection Assembly/BALWEIRETSECTION	Balance weight retaining wall may contain balance weight retaining wall section.
CANRETWALL	IfcSubgradeRetainingStructureSection Assembly/CANRETSECTION	Cantilever retaining wall may contain cantilever retaining wall section.
COURETWALL	IfcSubgradeRetainingStructureSection Assembly/COURETSECTION	Counterfort retaining wall may contain counterfort retaining wall section.
REICONRETWALL	IfcSubgradeRetainingStructureSection Assembly/REICONRETSECTION	Reinforced concrete retaining wall may contain reinforced concrete retaining wall section.
ANCBOLTRETWALL	IfcSubgradeRetainingStructureSection Assembly/ANCBOLTRETSECTION	Anchor bolt retaining wall may contain anchor bolt retaining wall section.
REIEARRETWALL	IfcSubgradeRetainingStructureSection Assembly/REIEARRETSECTION	Reinforced earth retaining wall may contain reinforced earth retaining wall section.
PRECABLE	IfcSubgradeRetainingStructureSection Assembly/PRECABLESECTION	Prestressed cable may contain prestressed cable section.
PILEFOUNRETWALL	IfcSubgradeRetainingStructureSection Assembly/PILEFOUNRETSECTION	Pile foundation retaining wall may contain pile foundation retaining wall section.
DOCKRETWALL	IfcSubgradeRetainingStructureSection Assembly/DOCKRETSECTION	Dock retaining wall may contain dock retaining wall section.
SHORTRELRETWALL	IfcSubgradeRetainingStructureSection Assembly/SHORTRELRETSECTION	Short relieving slab retaining wall may contain short relieving slab retaining wall section.
WINDBREAKWALL	IfcSubgradeRetainingStructureSection Assembly/WINDBREAKSECTION	Wind brake wall may contain wind brake wall section.
SOILNAILRATWALL	IfcSubgradeRetainingStructureSection	Soil nail retaining wall may

	Assembly/ SOILNAILRATSECTION	contain soil nail retaining wall section.
ANCPLARETWALL	IfcSubgradeRetainingStructureSection Assembly/ ANCPLARETSECTION	Anchored plate retaining wall may contain anchored plate retaining wall section.

**EXPRESS Specification:**

ENTITY IfcSubgradeRetainingStructureElement  
SUBTYPE OF (IfcSubgradeStructureElement);  
PredefinedType: IfcSubgradeRetainingStructureTypeEnum;  
END\_ENTITY;

**Attribute definitions:**

PreDefinedType: IfcSubgradeRetainingStructureElement may include gravity retaining wall, balance weight retaining wall, cantilever retaining wall, counterfort retaining wall, reinforced concrete retaining wall, anchor bolt retaining wall, reinforced earth retaining wall, prestressed cable, pile foundation retaining wall, dock retaining wall, short relieving slab retaining wall, wind brake wall, Soil nail retaining wall, anchored plate retaining wall and so on.

**8.3.6 IfcSubgradeSubsoilTreatmentElement**

IfcSubgradeSubsoilTreatmentElement is used to define block-based subgrade subsoil treatment. An IfcSubgrade usually contains an IfcSubgradeSubsoilTreatmentElement object. An IfcSubgradeSubsoilTreatmentElement is composed of one or more IfcSubgradeSubsoilReinforcementPileAssembly or IfcOriginalSubgradeSubsoilReinforcement objects.

**Table 8.12 Property sets for IfcSubgradeSubsoilTreatmentElement**

PredefinedType	Name
	Pset_SubgradeSubsoilTreatmentElementCommon

**Table 8.13 IfcSubgradeSubsoilTreatmentElement spatial composition**

Spatial Composite	Description
IfcSubgrade	IfcSubgradeSubsoilTreatmentElement is a component of IfcSubgrade.

**Table 8.14 IfcSubgradeSubsoilTreatmentElement spatial containment**

PredefinedType	Contained Entities	Description
	IfcSubgradeSubsoilReinforcementPileAssembly	IfcSubgradeSubsoilTreatmentElement may contain IfcSubgradeSubsoilReinforcementPileAssembly.
	IfcOriginalSubgradeSubsoilReinforcement	IfcSubgradeSubsoilTreatmentElement may contain IfcOriginalSubgradeSubsoilReinforcement.

**EXPRESS Specification:**

ENTITY IfcSubgradeSubsoilTreatmentElement  
SUBTYPE OF (IfcSubgradeStructureElement);  
PredefinedType: IfcSubgradeSubsoilTreatmentTypeEnum;

END\_ENTITY;

**Attribute definitions:**

PreDefinedType.

### 8.3.7 IfcSubgradeTransitionSectionStructureElement

IfcSubgradeTransitionSectionStructureElement is used to define the section requiring special treatment to connect the subgrade and structures, which is composed of IfcSubgradeTransitionSectionElement objects.

**Table 8.15 Property sets for IfcSubgradeTransitionSectionStructureElement**

PredefinedType	Name
EMBANKMENTCUTTING	Pset_EMBANKMENTCUTTING

**Table 8.16 IfcSubgradeTransitionSectionStructureElement spatial composition**

Spatial Composite	Description
IfcSubgrade	IfcSubgradeTransitionSectionStructureElement is a component of IfcSubgrade.

**Table 8.17 IfcSubgradeTransitionSectionStructureElement spatial containment**

PredefinedType	Contained Entities	Description
	IfcSubgradeTransitionSectionElement	IfcSubgradeTransitionSectionElement can be included in IfcSubgradeTransitionSectionStructureElement.

**EXPRESS Specification:**

ENTITY IfcSubgradeTransitionSectionStructureElement

SUBTYPE OF (IfcSubgradeStructureElement);

PredefinedType: IfcSubgradeTransitionSectionStructureTypeEnum;

END\_ENTITY;

**Attribute definitions:**

PreDefinedType: It contains embankment and abutment, embankment and lateral structure, embankment and cutting, cutting and abutment, cutting and tunnel, etc.

### 8.3.8 IfcSubgradeElement

IfcSubgradeElement is the supertype of all the physical elements in subgrade engineering.

**EXPRESS Specification:**

ENTITY IfcSubgradeElement

SUPERTYPE OF (ONEOF

(IfcSubgradeRetainingElement,IfcSubgradeFillingWorks,IfcSubgradeSlopeProtectionSectionElement,IfcSubgradeSubsoilReinforcementPileElement,IfcOriginalSubgradeSubsoilReinforcementElement))

SUBTYPE OF (IfcCivilElement);

END\_ENTITY;

### 8.3.9 IfcSubgradeRetainingElement

IfcSubgradeRetainingElement refers to the basic elements of subgrade retaining structure.

Some IfcSubgradeRetainingElements can compose IfcSubgradeRetainingStructureSectionAssembly.

**Table 8.18 Property sets for IfcSubgradeRetainingElement**

PredefinedType	Name
GRARETBODY	Pset_GRARETBODY
BALWEIRETBODY	Pset_BALWEIRETBODY
CANRETBODY	Pset_CANRETBODY
COURETBODY	Pset_COURETBODY
ANCHORAGEPILE	Pset_ANCHORAGEPILE
RETAININGPLATE	Pset_RETAININGPLATE
RIBBEDCOLUMN	Pset_RIBBEDCOLUMN
PANEL	Pset_PANEL
REIEARRETBODY	Pset_REIEARRETBODY
PRECABLEBODY	Pset_PRECABLEBODY

**Table 8.19 IfcSubgradeRetainingElement contained in Assembly**

Assembly	Description
IfcSubgradeRetainingStructureSectionAssembly	IfcSubgradeRetainingElement should be included in IfcSubgradeRetainingStructureSectionAssembly.

**EXPRESS Specification:**

```
ENTITY IfcSubgradeRetainingElement
  SUBTYPE OF (IfcSubgradeElement);
    PredefinedType: IfcSubgradeRetainingElementTypeEnum;
END_ENTITY;
```

**Attribute definitions:**

PreDefinedType: It contains gravity retaining wall body, balance weight retaining wall body, cantilever retaining wall body, counterfort retaining wall body, anchorage pile, retaining plate, ribbed column, panel, reinforced earth retaining wall body, wall foundation, prestressed cable body, pile foundation trimmer, dock retaining wall body, short relieving slab retaining wall body, wind brake wall body, Soil nail retaining wall body, anchor plate, anchor plate pullrod, wall panel, anchor ribbed column and so on.

**8.3.10 IfcSubgradeFillingWorks**

IfcSubgradeFillingWorks refers to the component of subgrade filling, and can compose IfcSubgradeStructurePartElement.

**Table 8.20 Property sets for IfcSubgradeFillingWorks**

PredefinedType	Name
	Pset_SubgradeFillingWorksCommon

**Table 8.21 IfcSubgradeFillingWorks contained in spatial structure**

Spatial Structure	Description
IfcSubgradeStructurePartElement	IfcSubgradeFillingWorks can be included in

	IfcSubgradeStructurePartElement.
--	----------------------------------

**EXPRESS Specification:**

ENTITY IfcSubgradeFillingWorks  
 SUBTYPE OF (IfcSubgradeElement);  
 PredefinedType: IfcSubgradeFillingWorksTypeEnum;  
 END\_ENTITY;

**Attribute definitions:**

PreDefinedType: It contains top layer subbed, bottom layer subbed, below subbed, replace subbed base and so on.

**8.3.11 IfcSubgradeSlopeProtectionSectionElement**

IfcSubgradeSlopeProtectionSectionElement refers to the basic elements of subgrade slope protection, and can compose IfcSubgradeSlopeProtectionElement.

**Table 8.22 Property sets for IfcSubgradeSlopeProtectionSectionElement**

PredefinedType	Name
	Pset_SubgradeSlopeProtectionSectionElementCommon

**Table 8.23 IfcSubgradeSlopeProtectionSectionElement contained in spatial structure**

Spatial Structure	Description
IfcSubgradeSlopeProtectionElement	IfcSubgradeSlopeProtectionSectionElement can be included in IfcSubgradeSlopeProtectionElement.

**EXPRESS Specification:**

ENTITY IfcSubgradeSlopeProtectionSectionElement  
 SUBTYPE OF (IfcSubgradeElement);  
 PredefinedType: IfcSubgradeSlopeProtectionSectionElementTypeEnum;  
 END\_ENTITY;

**Attribute definitions:**

PreDefinedType: It contains arch framework, hole type protective wall, mortar rubble, anchored frame beam, grid frame, diamond frame, human shaped frame, hollow brick, solid slope protection, and so on.

**8.3.12 IfcSubgradeSubsoilReinforcementPileElement**

IfcSubgradeSubsoilReinforcementPileElement refers to the pile foundation to improve the bearing capacity of foundation composed of soil or rock. IfcSubgradeSubsoilReinforcementPileElement can compose IfcSubgradeSubsoilReinforcementPileAssembly.

**Table 8.24 Property sets for IfcSubgradeSubsoilReinforcementPileElement**

PredefinedType	Name
	Pset_SubgradeSubsoilReinforcementPileElementCommon

**Table 8.25 IfcSubgradeSubsoilReinforcementPileElement contained in Assembly**

Assembly	Description
IfcSubgradeSubsoilReinforceme	IfcSubgradeSubsoilReinforcementPileElement should be



ntPileAssembly	included in IfcSubgradeSubsoilReinforcementPileAssembly.
----------------	--

**EXPRESS Specification:**

ENTITY IfcSubgradeSubsoilReinforcementPileElement

SUBTYPE OF (IfcSubgradeElement);

PredefinedType: IfcSubgradeSubsoilReinforcementPileElementTypeEnum;

END\_ENTITY;

**Attribute definitions:**

PreDefinedType: It contains pilebody and pilecap, etc.

**8.3.13 IfcOriginalSubgradeSubsoilReinforcement**

IfcOriginalSubgradeSubsoilReinforcement refers to the engineering measures such as compaction, rammed, and grouting to improve the bearing capacity of foundation. IfcOriginalSubgradeSubsoilReinforcement can compose IfcSubgradeSubsoilTreatmentElement.

**Table 8.26 Property sets for IfcOriginalSubgradeSubsoilReinforcement**

PredefinedType	Name
	Pset_OriginalSubgradeSubsoilReinforcementCommon

**Table 8.27 IfcOriginalSubgradeSubsoilReinforcemen contained in spatial structure**

Spatial Structure	Description
IfcSubgradeSubsoilTreatmentElement	IfcOriginalSubgradeSubsoilReinforcement can be included in IfcSubgradeSubsoilTreatmentElement.

**EXPRESS Specification:**

ENTITY IfcOriginalSubgradeSubsoilReinforcement

SUBTYPE OF (IfcSubgradeElement);

PredefinedType: IfcOriginalSubgradeSubsoilReinforcementTypeEnum;

END\_ENTITY;

**Attribute definitions:**

PreDefinedType: It contains compaction, rammed, grouting, sand wick, sheet drain and so on.

**8.3.14 IfcSubgradeTransitionSectionElement**

IfcSubgradeTransitionSectionElement refers to the basic elements of subgrade transition section. IfcSubgradeTransitionSectionElement can compose IfcSubgradeTransitionSectionStructureElement.

**Table 8.28 Property sets for IfcSubgradeTransitionSectionElement**

PredefinedType	Name
TRANSITIONCONE	Pset_TRANSITIONCONE
FOUNDATIONBACKFILLINGSOIL	Pset_FOUNDATIONBACKFILLINGSOIL
NONSANDCONPERPLATE	Pset_NONSANDCONPERPLATE
REPLACEMENTSOIL	Pset_REPLACEMENTSOIL

**Table 8.29 IfcSubgradeTransitionSectionElement contained in spatial structure**

Spatial Structure	Description
IfcSubgradeTransitionSectionStruc	AIfcSubgradeTransitionSectionElement can be included

tureElement	in IfcSubgradeTransitionSectionStructureElement.
-------------	--

**EXPRESS Specification:**

ENTITY IfcSubgradeTransitionSectionElement  
 SUBTYPE OF (IfcSubgradeElement);  
 PredefinedType: IfcSubgradeTransitionSectionElementTypeEnum;  
 END\_ENTITY;

**Attribute definitions:**

PreDefinedType: It contains transition cone, foundation backfilling soil, non-sand concrete permeable plate, replacement soil and so on.

**8.3.15 IfcSubgradeElementAssembly**

IfcSubgradeElementAssembly is the supertype of all the element assemblies in subgrade engineering.

**EXPRESS Specification:**

ENTITY IfcSubgradeElementAssembly  
 SUPERTYPE OF (ONEOF  
 (IfcSubgradeRetainingStructureSectionAssembly, IfcSubgradeSubsoilReinforcementPileAssembly)  
 SUBTYPE OF (IfcCivilElementAssembly);  
 END\_ENTITY;

**8.3.16 IfcSubgradeRetainingStructureSectionAssembly**

IfcSubgradeRetainingStructureSectionAssembly is composed of some IfcSubgradeRetainingElement objects. Some IfcSubgradeRetainingStructureSectionAssembly objects can compose IfcSubgradeRetainingStructureElement.

**Table 8.30 IfcSubgradeRetainingStructureSectionAssembly contained in spatial structure**

Spatial Structure	Description
IfcSubgradeRetainingStructureElement	IfcSubgradeRetainingStructureSectionAssembly can be included in IfcSubgradeRetainingStructureElement.

**Table 8.31 IfcSubgradeRetainingStructureSectionAssembly entity composition**

PredefinedType	Contained Entities	Description
	IfcSubgradeRetainin gElement	IfcSubgradeRetainingElement can be included in IfcSubgradeRetainingStructureSectionAssembly.

**EXPRESS Specification:**

ENTITY IfcSubgradeRetainingStructureSectionAssembly  
 SUBTYPE OF (IfcSubgradeElementAssembly);  
 PredefinedType: IfcSubgradeRetainingStructureSectionAssemblyTypeEnum;  
 END\_ENTITY;

**Attribute definitions:**

PreDefinedType: It contains gravity retaining wall section, balance weight retaining wall section, cantilever retaining wall section, counterfort retaining wall section, reinforced concrete

retaining wall section, anchor bolt retaining wall section, reinforced earth retaining wall section, prestressed cable section, pile foundation retaining wall section, dock retaining wall section, short relieving slab retaining wall section, wind brake wall section, Soil nail retaining wall section, anchored plate retaining wall section and so on.

### 8.3.17 IfcSubgradeSubsoilReinforcementPileAssembly

IfcSubgradeSubsoilReinforcementPileAssembly is composed of IfcSubgradeTransitionSectionElement. Some IfcSubgradeSubsoilReinforcementPileAssembly objects can compose IfcSubgradeSubsoilTreatmentElement.

**Table 8.32 IfcSubgradeSubsoilReinforcementPileAssembly contained in spatial structure**

Spatial Structure	Description
IfcSubgradeSubsoilTreatmentElement	IfcSubgradeSubsoilReinforcementPileAssembly can be included in IfcSubgradeSubsoilTreatmentElement.

**Table 8.33 IfcSubgradeSubsoilReinforcementPileAssembly entity composition**

PredefinedType	Contained Entities	Description
	IfcSubgradeRetaining Element	IfcSubgradeSubsoilReinforcementPileElement can be included in IfcSubgradeSubsoilReinforcementPileAssembly.

#### **EXPRESS Specification:**

```
ENTITY IfcSubgradeSubsoilReinforcementPileAssembly
  SUBTYPE OF (IfcSubgradeElementAssembly);
  PredefinedType: IfcSubgradeSubsoilReinforcementPileAssemblyTypeEnum;
  END_ENTITY;
```

#### **Attribute definitions:**

PreDefinedType: It contains cement mixing pile, lime-soil compaction pile, cement fly-ash gravel pile, chemical churning pile, column hammer expansion pile, cement soil compaction pile and so on.

## 8.4 Property Set Definition

### 8.4.1 Pset\_SubgradeStructurePartElementCommon

Name: Pset\_SubgradeStructurePartElementCommon

Applicable Entities: IfcSubgradeStructurePartElement

Description: Properties common to the definition of all occurrences of IfcSubgradeStructurePartElement.

Property Definitions: See Table 8.34.

**Table 8.34 Property definitions of Pset\_SubgradeStructurePartElementCommon**

Name	Type	Description
fillingmaximum	TypePropertySingleValue/IfcLengthMeasure/m	Indicates the maximum

		filling height.
diggingmaximum	TypePropertySingle Value/IfcLengthMeasure/m	Indicates the maximum digging depth.

#### 8.4.2 Pset\_SubgradeSlopeProtectionElementCommon

Name: Pset\_SubgradeSlopeProtectionElementCommon

Applicable Entities: IfcSubgradeSlopeProtectionElement

Description: Properties common to the definition of all occurrences of IfcSubgradeSlopeProtectionElement.

Property Definitions: See Table 8.35.

**Table 8.35 Property definitions of Pset\_SubgradeSlopeProtectionElementCommon**

Name	Type	Description
slopeprotectionsectionnumber	TypePropertySingle Value/IfcInteger	Indicates the number slope protection sections.
protectiontype	TypePropertySingle Value/IfcLabel	Protection type.
protectionarea	TypePropertySingle Value/IfcAreaMeasure/m <sup>2</sup>	Protection area.
protectionsectionlength	TypePropertySingle Value/IfcLengthMeasure/m	Indicates the length of the protection section.

#### 8.4.3 Pset\_SubgradeRetainingStructureElementCommon

Name: Pset\_SubgradeRetainingStructureElementCommon

Applicable Entities: IfcSubgradeRetainingStructureElement

Description: Properties common to the definition of all occurrences of IfcSubgradeRetainingStructureElement.

Property Definitions: See Table 8.36.

**Table 8.36 Property definitions of Pset\_SubgradeRetainingStructureElementCommon**

Name	Type	Description
wallsectionnumber	TypePropertySingle Value/IfcInteger	Indicates the number of wall sections.
expansionjointspacing	TypePropertySingle Value/IfcLengthMeasure/m	Expansion joint spacing.
expansionjointwidth	TypePropertySingle Value/IfcLengthMeasure/m	Indicates the width of the expansion joint.
wallsectionlength	TypePropertySingle Value/IfcLengthMeasure/m	Indicates the length of the wall section.

#### 8.4.4 Pset\_SubgradeSubsoilTreatmentElementCommon

Name: Pset\_SubgradeSubsoilTreatmentElementCommon

Applicable Entities: IfcSubgradeSubsoilTreatmentElement

Description: Properties common to the definition of all occurrences of

IfcSubgradeSubsoilTreatmentElement.

Property Definitions: See Table 8.37.

**Table 8.37 Property definitions of Pset\_SubgradeSubsoilTreatmentElementCommon**

Name	Type	Description
treatmentlength	TypePropertySingleValue/IfcLengthMeasure/m	Treatment length.
treatmentdepth	TypePropertySingleValue/IfcLengthMeasure/m	Treatment depth.
treatmentcapacity	TypePropertySingleValue/IfcPlanarForceMeasure/Pa	Capacity after treatment.
pilenumber	TypePropertySingleValue/IfcInteger	Pile number.
leftboundary	TypePropertySingleValue/IfcLengthMeasure/m	Left boundary.
rightboundary	TypePropertySingleValue/IfcLengthMeasure/m	Right boundary.

#### 8.4.5 Pset\_REICONRETWALL

Name: Pset\_REICONRETWALL

Applicable Entities: IfcSubgradeRetainingStructure/REICONRETWALL

Description: A set of properties of reinforced concrete retaining walls.

Property Definitions: See Table 8.38.

**Table 8.38 Property definitions of Pset\_REICONRETWALL**

Name	Type	Description
anchorpilesnumber	TypePropertySingleValue/IfcInteger	The number of anchor piles.
retainingplatenumber	TypePropertySingleValue/IfcInteger	The number of retaining plates.

#### 8.4.6 Pset\_ANCBOLTRETWALL

Name: Pset\_ANCBOLTRETWALL

Applicable Entities: IfcSubgradeRetainingStructure/ANCBOLTRETWALL

Description: A set of properties of anchor bolt retaining walls.

Property Definitions: See Table 8.39.

**Table 8.39 Property definitions of Pset\_ANCBOLTRETWALL**

Name	Type	Description
ribbedcolumnnumber	TypePropertySingleValue/IfcInteger	Ribbed column number.
panelnumber	TypePropertySingleValue/IfcInteger	Panel number.
anchoredboltnumber	TypePropertySingleValue/IfcInteger	Anchored bolt number.

#### 8.4.7 Pset\_EMBANKMENTCUTTING

Name: Pset\_EMBANKMENTCUTTING

Applicable Entities: IfcSubgradeTransitionSectionStructure/EMBANKMENTCUTTING

Description: A set of properties of embankment and cutting.

Property Definitions: See Table 8.40.

**Table 8.40 Property definitions of Pset\_EMBANKMENTCUTTING**

Name	Type	Description
------	------	-------------

stepheight	TypePropertySingleValue/IfcLengthMeasure/m	Step height.
firststepheight	TypePropertySingleValue/IfcLengthMeasure/m	First step height.
longitudinaldepth	TypePropertySingleValue/IfcLengthMeasure/m	Longitudinal depth.

#### 8.4.8 Pset\_SubgradeFillingWorksCommon

Name: Pset\_SubgradeFillingWorksCommon

Applicable Entities: IfcSubgradeFillingWorks

Description: Properties common to the definition of all occurrences of IfcSubgradeFillingWorks.

Property Definitions: See Table 8.41.

**Table 8.41 Property definitions of Pset\_SubgradeFillingWorksCommon**

Name	Type	Description
fillingheight	TypePropertySingleValue/IfcLengthMeasure/m	Filling height.
fillingname	TypePropertySingleValue/IfcLabel	Filling name.
fillingvolume	TypePropertySingleValue/IfcVolumeMeasure/m <sup>3</sup>	Filling volume.
compactiondegree	TypePropertySingleValue/ IfcModulusOfSubgradeReacionMeasure	Compaction degree.
moisturedegree	TypePropertySingleValue/IfcNormalisedRatioMeasure	Moisture degree.

#### 8.4.9 Pset\_SubgradeSlopeProtectionSectionElementCommon

Name: Pset\_SubgradeSlopeProtectionSectionElementCommon

Applicable Entities: IfcSubgradeSlopeProtectionSectionElement

Description: Properties common to the definition of all occurrences of IfcSubgradeSlopeProtectionSectionElement.

Property Definitions: See Table 8.42.

**Table 8.42 Property definitions of Pset\_SubgradeSlopeProtectionSectionElementCommon**

Name	Type	Description
height	TypePropertySingleValue/IfcLengthMeasure/m	height
width	TypePropertySingleValue/IfcLengthMeasure/m	width
mortarrubbletype	TypePropertySingleValue/IfcLabel	material

#### 8.4.10 Pset\_SubgradeSubsoilReinforcementPileElementCommon

Name: Pset\_SubgradeSubsoilReinforcementPileElementCommon

Applicable Entities: IfcSubgradeSubsoilReinforcementPileElement

Description: Properties common to the definition of all occurrences of IfcSubgradeSubsoilReinforcementPileElement.

Property Definitions: See Table 8.43.

**Table 8.43 Property definitions of Pset\_SubgradeSubsoilReinforcementPileElementCommon**

Name	Type	Description
waterdepth	TypePropertySingleValue/IfcLengthMeasure/m	Water depth.

#### 8.4.11 Pset\_OriginalSubgradeSubsoilReinforcementCommon

Name: Pset\_OriginalSubgradeSubsoilReinforcementCommon

Applicable Entities: IfcOriginalSubgradeSubsoilReinforcement

Description: Properties common to the definition of all occurrences of IfcOriginalSubgradeSubsoilReinforcement.

Property Definitions: See Table 8.44.

**Table 8.44 Property definitions of Pset\_OriginalSubgradeSubsoilReinforcementCommon**

Name	Type	Description
reinforcearea	TypePropertySingleValue/IfcAreaMeasure/m <sup>2</sup>	Reinforcement area.
engineeringquantity	TypePropertySingleValue/IfcInteger	Engineering quantity.

#### 8.4.12 Pset\_GRARETBODY

Name: Pset\_GRARETBODY

Applicable Entities: IfcSubgradeRetainingElement/GRARETBODY

Description: A set of properties of gravity retaining wall body.

Property Definitions: See Table 8.45.

**Table 8.45 Property definitions of Pset\_GRARETBODY**

Name	Type	Description
totalheight	TypePropertySingleValue/IfcLengthMeasure/m	Total height.
topwidth	TypePropertySingleValue/IfcLengthMeasure/m	Top width.
positivesloperatio	TypePropertySingleValue/IfcRatioMeasure	Positive slope ratio.
backsloperatio	TypePropertySingleValue/IfcRatioMeasure	Back slope ratio.
bottomratio	TypePropertySingleValue/IfcRatioMeasure	Bottom ratio.

#### 8.4.13 Pset\_BALWEIRETBODY

Name: Pset\_BALWEIRETBODY

Applicable Entities: IfcSubgradeRetainingElement/BALWEIRETBODY

Description: A set of properties of balance weight retaining wall body.

Property Definitions: See Table 8.46.

**Table 8.46 Property definitions of Pset\_BALWEIRETBODY**

Name	Type	Description
totalheight	TypePropertySingleValue/IfcLengthMeasure/m	Total height.
upperwallheight	TypePropertySingleValue/IfcLengthMeasure/m	Upper wall height.
topwidth	TypePropertySingleValue/IfcLengthMeasure/m	Top width.
platformwidth	TypePropertySingleValue/IfcLengthMeasure/m	Platform width.
positivesloperatio	TypePropertySingleValue/IfcRatioMeasure	Positive slope ratio.

upbackslopeoperatio	TypePropertySingleValue/IfcRatioMeasure	Up back-slope ratio.
bottombackslopeoperatio	TypePropertySingleValue/IfcRatioMeasure	Bottom back-slope ratio.

#### 8.4.14 Pset\_CANRETBODY

Name: Pset\_CANRETBODY

Applicable Entities: IfcSubgradeRetainingElement/CANRETBODY

Description: A set of properties of cantilever retaining wall body.

Property Definitions: See Table 8.47.

**Table 8.47 Property definitions of Pset\_CANRETBODY**

Name	Type	Description
totalheight	TypePropertySingleValue/IfcLengthMeasure/m	Total height.
topwidth	TypePropertySingleValue/IfcLengthMeasure/m	Top width.
positivesloperatio	TypePropertySingleValue/IfcRatioMeasure	Positive slope ratio.
backslopeoperatio	TypePropertySingleValue/IfcRatioMeasure	Back slope ratio.

#### 8.4.15 Pset\_COURETBODY

Name: Pset\_COURETBODY

Applicable Entities: IfcSubgradeRetainingElement/COURETBODY

Description: A set of properties of counterfort retaining wall body.

Property Definitions: See Table 8.48.

**Table 8.48 Property definitions of Pset\_COURETBODY**

Name	Type	Description
totalheight	TypePropertySingleValue/IfcLengthMeasure/m	Total height.
wallwidth	TypePropertySingleValue/IfcLengthMeasure/m	Wall width.
floorheight	TypePropertySingleValue/IfcLengthMeasure/m	Floor height.
armspacing	TypePropertySingleValue/IfcLengthMeasure/m	Arm spacing.
armthickness	TypePropertySingleValue/IfcLengthMeasure/m	Arm thickness.

#### 8.4.16 Pset\_ANCHORAGEPILE

Name: Pset\_ANCHORAGEPILE

Applicable Entities: IfcSubgradeRetainingElement/ANCHORAGEPILE

Description: A collection of properties applicable to anchorage piles for subgrade retaining.

Property Definitions: See Table 8.49.

**Table 8.49 Property definitions of Pset\_ANCHORAGEPILE**

Name	Type	Description
pilelength	TypePropertySingleValue/IfcLengthMeasure/m	Pile length.
embeddingdepth	TypePropertySingleValue/IfcLengthMeasure/m	Embedding depth.
crosssectionshape	TypePropertySingleValue/IfcLabel	Cross section shape.
pilespacing	TypePropertySingleValue/IfcLengthMeasure/m	Pile spacing.

#### 8.4.17 Pset\_RETAININGPLATE

Name: Pset\_RETAININGPLATE



Applicable Entities: IfcSubgradeRetainingElement/RETAININGPLATE

Description: A collection of properties applicable to retaining plates for subgrade retaining.

Property Definitions: See Table 8.50.

**Table 8.50 Property definitions of Pset\_RETAININGPLATE**

Name	Type	Description
platethickness	TypePropertySingleValue/IfcLengthMeasure/m	Plate thickness.
platewidth	TypePropertySingleValue/IfcLengthMeasure/m	Plate width.

#### 8.4.18 Pset\_RIBBEDCOLUMN

Name: Pset\_RIBBEDCOLUMN

Applicable Entities: IfcSubgradeRetainingElement/RIBBEDCOLUMN

Description: A collection of properties applicable to ribbed columns for subgrade retaining.

Property Definitions: See Table 8.51.

**Table 8.51 Property definitions of Pset\_RIBBEDCOLUMN**

Name	Type	Description
totalheight	TypePropertySingleValue/IfcLengthMeasure/m	Total height of the wall.
wallbottomsupportcondition	TypePropertySingleValue/IfcLabel	Wall bottom support condition.

#### 8.4.19 Pset\_PANEL

Name: Pset\_PANEL

Applicable Entities: IfcSubgradeRetainingElement/PANEL

Description: A collection of properties applicable to panels for subgrade retaining.

Property Definitions: See Table 8.52.

**Table 8.52 Property definitions of Pset\_PANEL**

Name	Type	Description
retainingplatewidth	TypePropertySingleValue/IfcLengthMeasure/m	Indicates the width of the retaining plate.
retainingplatethickness	TypePropertySingleValue/IfcLengthMeasure/m	Indicates the thickness of the retaining plate.

#### 8.4.20 Pset\_REIEARRETBODY

Name: Pset\_REIEARRETBODY

Applicable Entities: IfcSubgradeRetainingElement/REIEARRETBODY

Description: A collection of properties applicable to reinforced earth retaining wall body.

Property Definitions: See Table 8.53.

**Table 8.53 Property definitions of Pset\_REIEARRETBODY**

Name	Type	Description
totalheight	TypePropertySingleValue/IfcLengthMeasure/m	Total height of the wall.

bandthickness	TypePropertySingleValue/IfcLengthMeasure/m	The thickness of the band.
verticalsegment	TypePropertySingleValue/IfcInteger	The number of vertical segments.

#### 8.4.21 Pset\_PRECABLEBODY

Name: Pset\_PRECABLEBODY

Applicable Entities: IfcSubgradeRetainingElement/PRECABLEBODY

Description: A collection of properties applicable to prestressed cable body.

Property Definitions: See Table 8.54.

**Table 8.54 Property definitions of Pset\_PRECABLEBODY**

Name	Type	Description
steelwirediameter	TypePropertySingleValue/IfcLengthMeasure/m	The diameter of steel wire.
steelwirelength	TypePropertySingleValue/IfcLengthMeasure/m	The length of steel wire.
boreholelength	TypePropertySingleValue/IfcLengthMeasure/m	The length of bore hole.

#### 8.4.22 Pset\_REPSUBBASE

Name: Pset\_REPSUBBASE

Applicable Entities: IfcSubgradeFillingWorks/REPSUBBASE

Description: A collection of properties applicable to subbed bases.

Property Definitions: See Table 8.55.

**Table 8.55 Property definitions of Pset\_REPSUBBASE**

Name	Type	Description
filltype	TypePropertySingleValue/IfcLabel	Filling type.
fillmaterial	TypePropertySingleValue/ IfcLabel	Filling material.
diggingbasetype	TypePropertySingleValue/IfcLabel	Digging base type.

#### 8.4.23 Pset\_PILECAP

Name: Pset\_PILECAP

Applicable Entities: IfcSubgradeSubsoilReinforcementPileElement/PILECAP

Description: A collection of properties applicable to pile caps.

Property Definitions: See Table 8.56.

**Table 8.56 Property definitions of Pset\_PILECAP**

Name	Type	Description
thickness	TypePropertySingleValue/IfcLengthMeasure/m	thickness
diameter	TypePropertySingleValue/IfcLengthMeasure/m	diameter
volume	TypePropertySingleValue/IfcVolumeMeasure/m <sup>3</sup>	volume

#### 8.4.24 Pset\_PILEBODY

Name: Pset\_PILEBODY

Applicable Entities: IfcSubgradeSubsoilReinforcementPileElement/PILEBODY

Description: A collection of properties applicable to pile body for subgrade reinforcement piles.

Property Definitions: See Table 8.57.

**Table 8.57 Property definitions of Pset\_PILEBODY**

Name	Type	Description
pile length	TypePropertySingleValue/IfcLengthMeasure/m	Pile length.
diameter	TypePropertySingleValue/IfcLengthMeasure/m	Diameter.
volume	TypePropertySingleValue/IfcVolumeMeasure/m <sup>3</sup>	Volume.

#### 8.4.25 Pset\_COMPACTION

Name: Pset\_COMPACTION

Applicable Entities: IfcSubgradeOriginalSubgradeSubsoilReinforcement/COMPACTION

Description: A collection of properties applicable to compaction subgrade.

Property Definitions: See Table 8.58.

**Table 8.58 Property definitions of Pset\_COMPACTION**

Name	Type	Description
compactionarea	TypePropertySingleValue/IfcAreaMeasure/m <sup>2</sup>	Compaction area.
engineeringquantity	TypePropertySingleValue/IfcInteger	Engineering quantity.
K30	TypePropertySingleValue/ IfcModulusOfSubgradeReacionMeasure/ N/m <sup>3</sup>	K30 test value.

#### 8.4.26 Pset\_RAMMED

Name: Pset\_RAMMED

Applicable Entities: IfcSubgradeOriginalSubgradeSubsoilReinforcement/RAMMED

Description: A collection of properties applicable to rammed subgrade.

Property Definitions: See Table 8.59.

**Table 8.59 Property definitions of Pset\_RAMMED**

Name	Type	Description
rammedarea	TypePropertySingleValue/IfcAreaMeasure/m <sup>2</sup>	Rammed area.
engineeringquantity	TypePropertySingleValue/IfcInteger	Engineering quantity.
K30	TypePropertySingleValue/ IfcModulusOfSubgradeReacionMeasure/ N/m <sup>3</sup>	K30 test value.

#### 8.4.27 Pset\_GROUTING

Name: Pset\_GROUTING

Applicable Entities: IfcSubgradeOriginalSubgradeSubsoilReinforcement/GROUTING

Description: A collection of properties applicable to grouting for original subgrade subsoil reinforcement.

Property Definitions: See Table 8.60.

**Table 8.60 Property definitions of Pset\_GROUTING**

Name	Type	Description
groutingvolume	TypePropertySingleValue/IfcVolumeMeasure/m <sup>3</sup>	Grouting volume.
materialtype	TypePropertySingleValue/IfcLabel	Material type.

#### 8.4.28 Pset\_TRANSITIONCONE

Name: Pset\_TRANSITIONCONE

Applicable Entities: IfcSubgradeTransitionSectionElement/TRANSITIONCONE

Description: A collection of properties applicable to transition cone for subgrade transition section.

Property Definitions: See Table 8.61.

**Table 8.61 Property definitions of Pset\_TRANSITIONCONE**

Name	Type	Description
bottomdepth	TypePropertySingleValue/IfcLengthMeasure/m	Bottom depth.
crosssectionsloperatio	TypePropertySingleValue/IfcRatioMeasure	Cross section slope ratio.
originalthickness	TypePropertySingleValue/IfcLengthMeasure/m	Original thickness.
longitudinalsectionsloperatio	TypePropertySingleValue/IfcRatioMeasure	Longitudinal section slope ratio.
equalthicknessdepth	TypePropertySingleValue/IfcLengthMeasure/m	Equal thickness depth
variousthicknessdepth	TypePropertySingleValue/IfcLengthMeasure/m	Various thickness depth.

#### 8.4.29 Pset\_FOUNDATIONBACKFILLINGSOIL

Name: Pset\_FOUNDATIONBACKFILLINGSOIL

Applicable Entities: IfcSubgradeTransitionSectionElement/FOUNDATIONBACKFILLINGSOIL

Description: A set of properties of foundation backfilling soil.

Property Definitions: See Table 8.62.

**Table 8.62 Property definitions of Pset\_FOUNDATIONBACKFILLINGSOIL**

Name	Type	Description
backfillmaterial	TypePropertySingleValue/IfcLabel	Backfill material.
backfillvolume	TypePropertySingleValue/IfcVolumeMeasure/m <sup>3</sup>	Backfill volume.

#### 8.4.30 Pset\_NONSANDCONPERPLATE

Name: Pset\_NONSANDCONPERPLATE

Applicable Entities: IfcSubgradeTransitionSectionElement/NONSANDCONPERPLATE

Description: A set of properties of non-sand concrete permeable plates.

Property Definitions: See Table 8.63.

**Table 8.63 Property definitions of Pset\_NONSANDCONPERPLATE**

Name	Type	Description
platethickness	TypePropertySingleValue/IfcLengthMeasure/m	Plate thickness.
plateheight	TypePropertySingleValue/IfcLengthMeasure/m	Plate height.

#### 8.4.31 Pset\_REPLACEMENTSOIL

Name: Pset\_REPLACEMENTSOIL

Applicable Entities: IfcSubgradeTransitionSectionElement/REPLACEMENTSOIL

Description: A set of properties of replacement soil.

Property Definitions: See Table 8.64.

**Table 8.64 Property definitions of Pset\_REPLACEMENTSOIL**

<b>Name</b>	<b>Type</b>	<b>Description</b>
fillthickness	TypePropertySingleValue/IfcLengthMeasure/m	Filling thickness.
fillmaterial	TypePropertySingleValue/IfcLabel	Filling material.

## **9. Bridge Schema**

### **9.1 Schema Definition**

The information model defined in this schema includes beam bridge, arch bridge, rigid frame bridge, cable-stayed bridge, suspension bridge, frame bridge, culvert and their main components.

The basic data architecture of bridge information model is composed of IfcBridgeStructureElement, IfcBridgeElementAssembly and IfcBridgeElement.

IfcBridgeStructureElement includes IfcBridge and IfcBridgePart.

IfcBridgeElementAssembly includes IfcBridgeTruss, IfcBridgeJoint, IfcBeamFallingPreventionDevice and IfcCrossBrace.

IfcBridgeElement includes IfcBridgeMember, IfcStiffeningRib, IfcBridgeSlab, IfcBridgeGirderSegment, IfcBridgeGearBlocks, IfcBridgeBedstone, IfcBridgePierSegment, IfcBridgeAbutmentSegment, IfcBridgePylon, IfcBridgeArchrib, IfcBridgeArchfoot, IfcBridgeStandColumn, IfcBridgeSuspender, IfcBridgeCable, IfcBridgeSuspendedTendon, IfcBridgeBearing, IfcBridgeExpansionInstallation, IfcBridgeProtectingWall, IfcBridgeFrameSegment, IfcBridgeWingWall, IfcBridgeCulvertSegment, IfcBridgeHatStone, IfcBridgeCoping, IfcBridgeEmbeddedPartsFoundation and IfcBridgeRefugePlatform.

The relationship between all the classes in the bridge domain is shown in Figure 9.1.

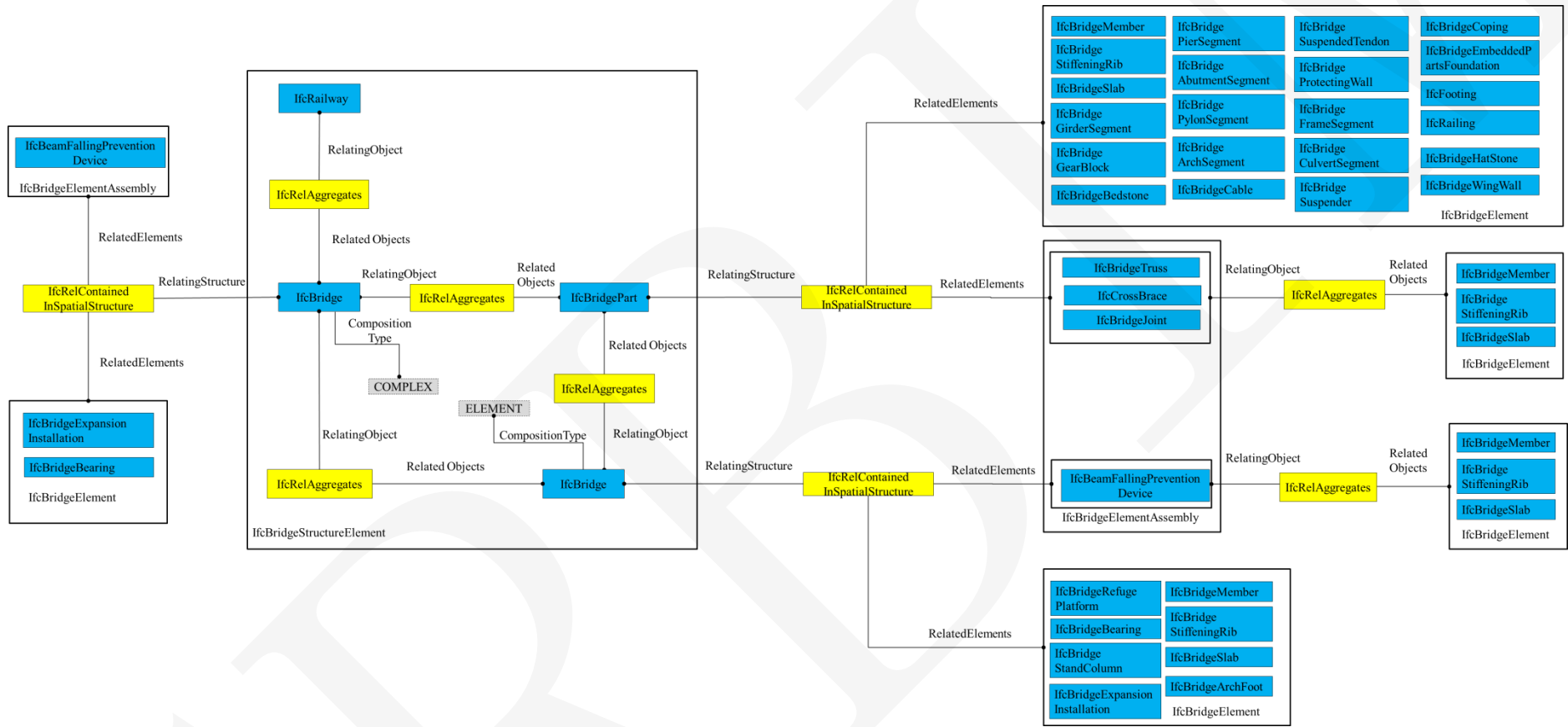
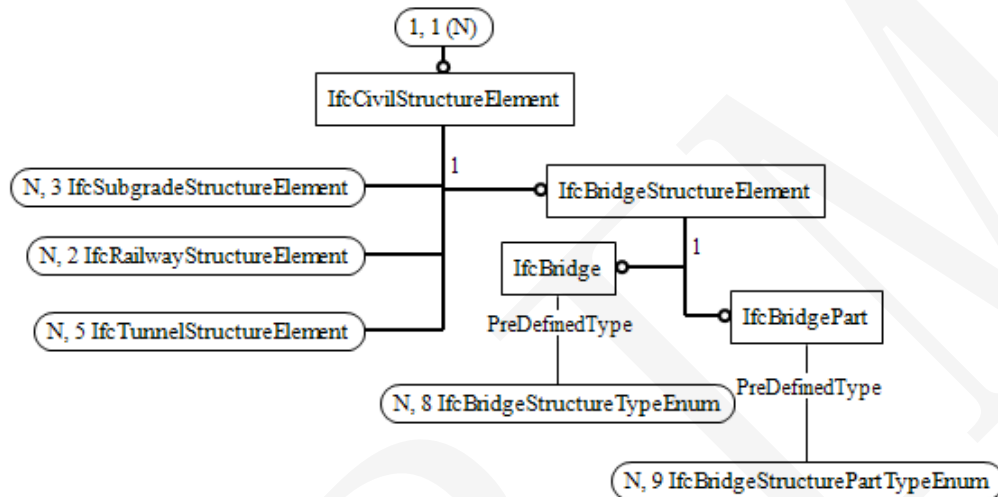

Figure 9.1 Bridge composition

### 9.1.1 Spatial Structure Elements of Bridge

Firstly, the `IfcBridgeStructureElement` is derived from the `IfcCivilStructureElement`, and it is the supertype of all the spatial structure elements in bridge engineering. Then `IfcBridge` and `IfcBridgePart` are derived from the `IfcBridgeStructureElement`. The inheritance relationship between the spatial structure elements in bridge domain is shown in Figure 9.2.



**Figure 9.2 EXPRESS-G diagram for `IfcBridgeStructureElements`**

`IfcBridgeStructureElement` inherits from `IfcCivilStructureElement`, and is the supertype of all the spatial structure elements of bridge.

`IfcBridge` refers to a bridge which may be a single structure bridge or a composite bridge comprised of one or more single structure bridges and bridge parts.

A single structure bridge is usually comprised of `IfcBridgePart` such as bridge girder, pier, foundation and abutment, and `IfcBridgeElement` such as bridge expansion installation, bridge bearing, etc.

A composite bridge is usually comprised of one or more single structure bridges and `IfcBridgePart` such as bridge girder, pier, foundation and abutment, and `IfcBridgeElement` such as bridge expansion installation, bridge bearing, etc.

When `IfcBridge` refers to a single structure bridge, the “CompositionType” property that inherited from the `IfcSpatialStructureElement` should be ELEMENT. When `IfcBridge` refers to a composite bridge, the “CompositionType” property that inherited from the `IfcSpatialStructureElement` should be COMPLEX. As is shown in Figure 9.3.

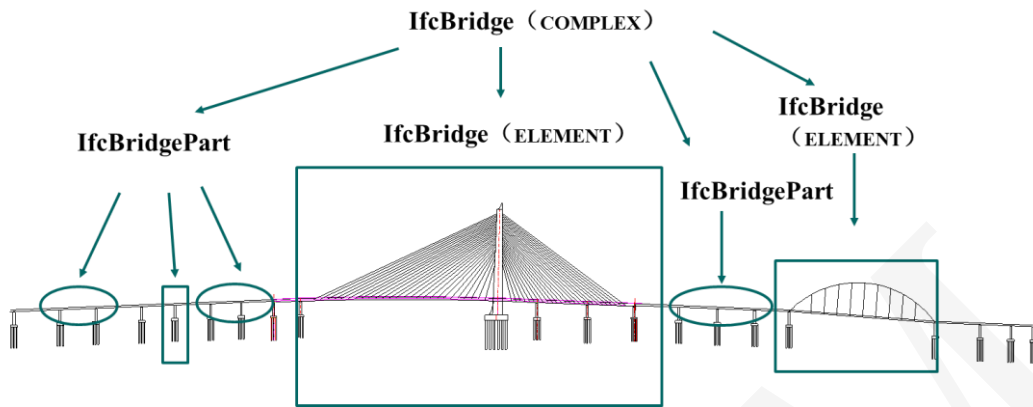

**Figure 9.3 Sketch map of bridge spatial structure decomposition (IfcBridge (COMPLEX))**

IfcBridge is further subdivided into GIRDERBRIDGE, ARCHBRIDGE, RIGIDFRAMEBRIDGE, CABLESTAYEDBRIDGE, SUSPENSIONBRIDGE, FRAMEBRIDGE and CULVERT by predefined types.

IfcBridgePart refers to the various parts of the IfcBridge from the perspective of spatial structure. IfcBridgePart is further subdivided into GIRD, ABUTMENT, PIRE, PYLONS, CABLES, ARCH, SUSPENDERS, FOUNDATION, SUSPENDED TENDONS and BRIDGEFLOORSYSTEM by predefined types. As is shown in Figure 9.4.

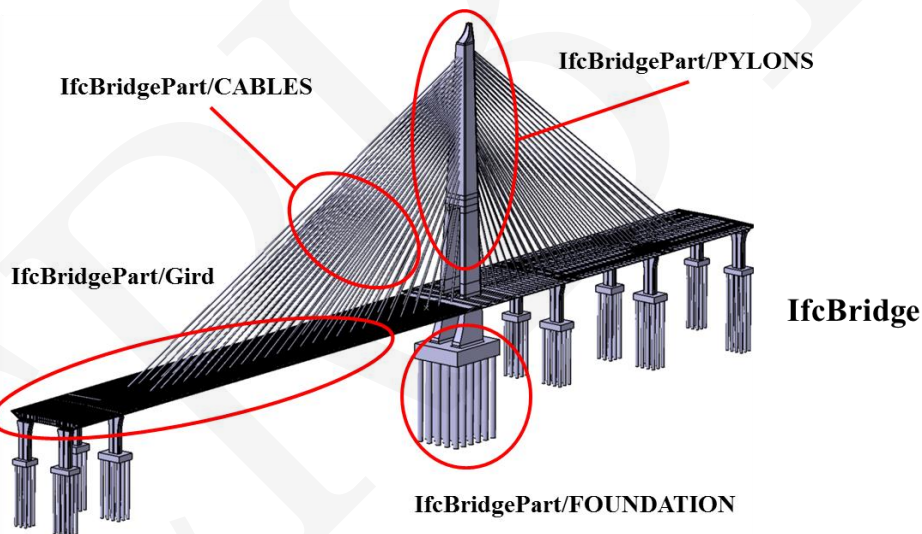

**Figure 9.4 Sketch map of bridge spatial structure decomposition (IfcBridge (ELEMENT))**

### 9.1.2 Physical Elements of Bridge

IfcBridgeElement is derived from IfcCivilElement, which is the supertype of all the physical elements in bridge engineering. Then IfcBridgeElement derives IfcBridgeMember, IfcStiffeningRib, IfcBridgeSlab, IfcBridgeGirderSegment, IfcBridgeGearBlocks, IfcBridgeBedstone, IfcBridgePierSegment, IfcBridgeAbutmentSegment, IfcBridgePylon, IfcBridgeArchrib, IfcBridgeArchfoot, IfcBridgeStandColumn, IfcBridgeSuspender, IfcBridgeCable, IfcBridgeSuspendedTendon, IfcBridgeBearing, IfcBridgeExpansionInstallation, IfcBridgeProtectingWall, IfcBridgeFrameSegment, IfcBridgeWingWall, IfcBridgeCulvertSegment,



IfcBridgeHatStone, IfcBridgeCoping, IfcBridgeEmbeddedPartsFoundation, and IfcBridgeRefugePlatform.

The inheritance relationship between the physical elements of bridge is shown in Figure 9.5.

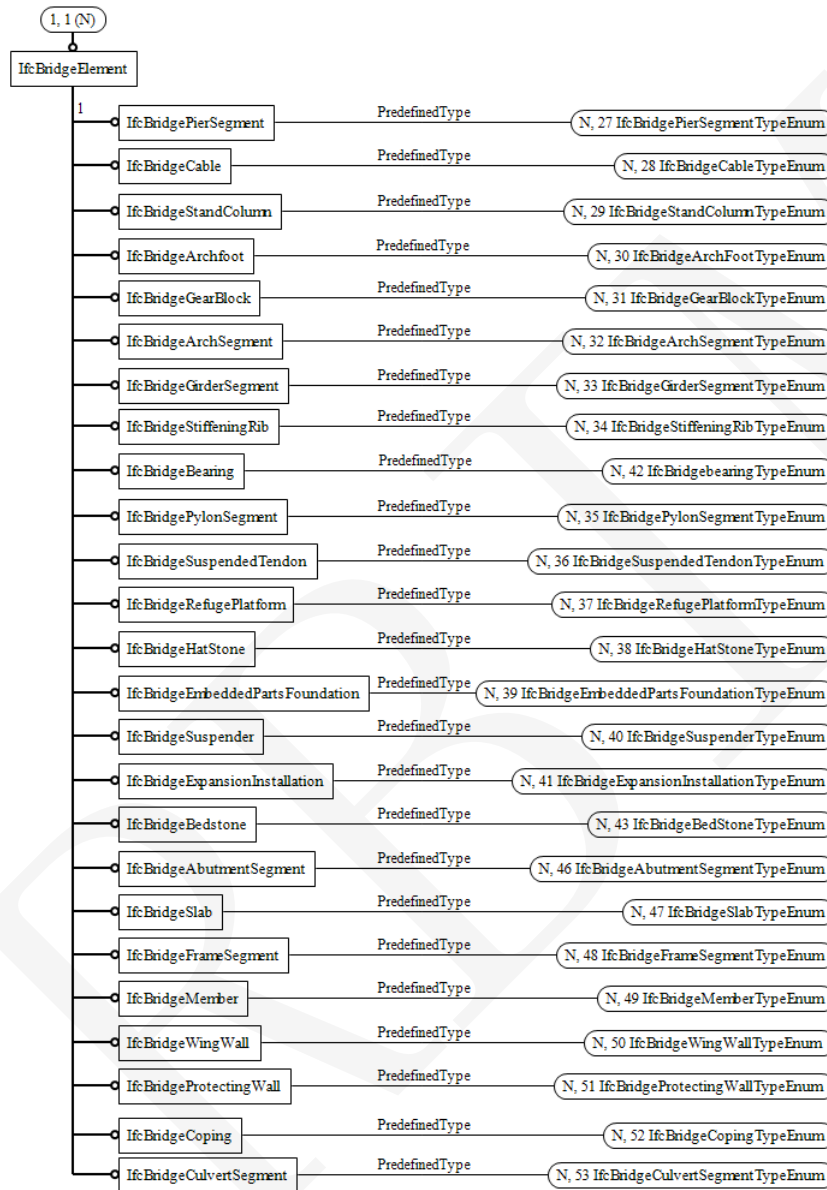

**Figure 9.5 EXPRESS-G diagram for IfcBridgeElements**

IfcBridgeElement is derived from IfcCivilElement and is the supertype of all the physical elements of bridge.

IfcBridgeMember refers to the components of truss such as chord, longitudinal beam, cross beam, etc. Considering that the bridge members are generally the main bearing components with complex structure, so this schema don't directly reference the original IfcMember in IFC4 schema.

IfcStiffeningRib refers to stiffening structure such as U-shape rib, plate rib, etc.

IfcBridgeSlab refers to the gusset plate, bridge deck, splice plate, cantilever plate, pavement plate and web plate, and the thickness can be changed. In IFC4, IfcSlab refers to ceiling, floor and

stair board in the building, and IfcPlate mainly refers to the flat plate with a uniform thickness. IfcSlab and IfcPlate can't fully meet the requirements for the bridge slabs, therefore this schema don't directly use IfcSlab or IfcPlate to define the bridge slabs.

IfcBridgeGirderSegment refers to the segment of the main girder of the bridge. Because the main girder is constructed segment by segment and the section size of the main girder is different at different locations, so the main girder is not defined as a physical element.

IfcBridgeGearBlocks refers to the wedge structure of anchorage prestressed steel strand. The gear block is generally designed separately, so it is defined as an entity.

IfcBridgeBedstone refers to the structure placed on the top of the pier or abutment to support the bearing.

IfcBridgePierSegment refers to the pier shaft segment, the top cap or the tray. Because the bridge pier is poured segment by segment in the construction process and the materials of the pier, the top cap and the tray are different, so the bridge pier is not defined as a physical element.

IfcBridgeAbutmentSegment refers to the components of the abutment. Because the bridge abutment is poured segment by segment in the construction process, so the bridge abutment is not defined as a physical element.

IfcBridgePylonsegment refers to the components of the pylon. Because the bridge pylon is poured or assembled segment by segment in the construction process, so the bridge pylon is not defined as a physical element.

IfcBridgeArchrib refers to the components of the arch. Because the bridge arch is poured or assembled segment by segment in the construction process, so the bridge arch is not defined as a physical element.

IfcBridgeArchfoot refers to the structure used to support the arch rib and connect the foundation or main girder to the arch rib.

IfcBridgeStandColumn refers to the structure on the arch rib to support the main girder.

IfcBridgeSuspender refers to the structure used to connect the suspension cable or the arch rib with the bridge floor system. A bridge suspender comprises a hanger body, sheath, sleeve, bolts, etc.

IfcBridgeCable refers to the structure used to connect the pylon with the bridge floor system. A bridge cable comprises a hanger body, sheath, sleeve, bolts, etc.

IfcBridgeSuspendedTendon refers to the single suspension cable, which comprises steel wire, sheath, etc.

IfcBridgeBearing refers to the structure used to support the main girder and transfer the load from the superstructure to the bridge pier.

IfcBridgeExpansionInstallation refers to the structure installed on between two main girders to facilitate the vehicle smoothly pass the bridge deck and to meet the deformation of the upper

structure of the bridge. It is comprised of rubber and steel parts.

IfcBridgeProtectingWall refers to the structure located on the bridge deck to protect the pedestrians and to retain the ballast. The IfcWall defined in IFC4 mainly refers to the wall of the building. In order to emphasize the specific meaning of the bridge protection wall, IfcWall is not used.

IfcBridgeFrameSegment refers to a segment of a frame bridge. Because the main body of the frame bridge is casted or assembled segment by segment in the construction process, so the frame bridge is not defined as a physical element.

IfcBridgeWingWall refers to the structure at the inlet and outlet of a culvert or a frame bridge to ensure the two sides of the embankment slope stability and to guide the river. The IfcWall defined in IFC4 mainly refers to the wall of the building. To emphasize the specific meaning of the bridge wing wall, IfcWall is not used.

IfcBridgeCulvertSegment refers to a segment of a culvert. Because the culvert body is usually designed and constructed segment by segment in the design and construction process, so the culvert is not defined as a physical element.

IfcBridgeHatStone refers to the structure located on the end of the wing wall of the culvert to support the subgrade filling material.

IfcBridgeCoping refers to the structure set on the top of the frame or the double column pier to support, distribute and transfer the load of the upper structure, also known as cap beam.

IfcBridgeEmbeddedPartsFoundation refers to the joint structure placed on bridge deck or piers to connect other structures.

IfcBridgeRefugePlatform refers to the platform on the bridge for maintenance personnel to avoid the train.

### **9.1.3 Element Assemblies of Bridge**

IfcBridgeElementAssembly is derived from the IfcCivilElementAssembly and is the supertype of all the element assemblies in bridge engineering. Then IfcBridgeElementAssembly derives IfcBridgeTruss, IfcBridgeJoint, IfcBeamFallingPreventionDevice and IfcCrossBrace. The inheritance relationship between the element assemblies of the bridge is shown in Figure 9.6.

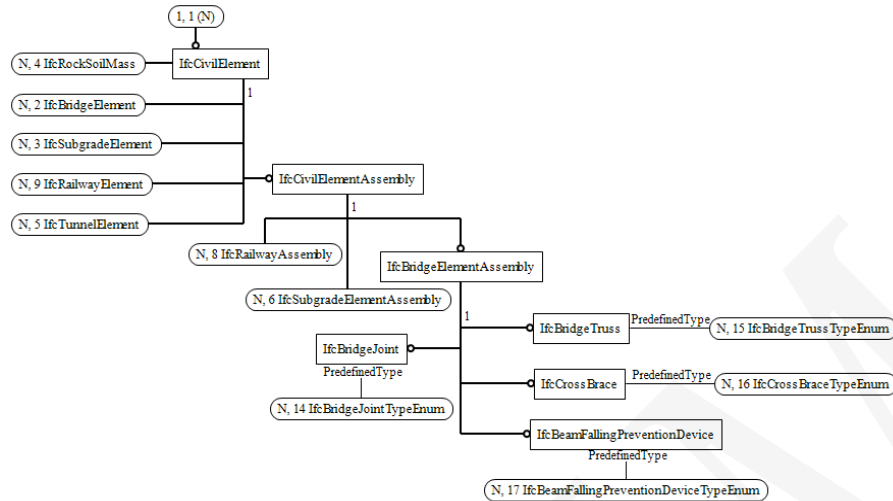

**Figure 9.6 EXPRESS-G diagram for IfcBridgeElementAssembly**

IfcBridgeElementAssembly, inherited from IfcCivilElementAssembly, is the supertype of all the element assemblies in bridge engineering. It has 4 subtypes which are IfcBridgeTruss, IfcBridgeJoint, IfcBeamFallingPreventionDevice and IfcCrossBrace.

IfcBridgeTruss refers to a truss structure comprised of members and is a part of a steel truss bridge. In IFC4, there is the definition of truss, but it is only an enumeration value of IfcElementAssembly. The truss structure in the bridge is complex and the original definition in IFC4 can not fully express the concept of truss in the bridge structure, so IfcBridgeTruss is defined.

IfcBridgeJoint refers to the structure to connect the members of the truss. It is constituted by members, plates, stiffening ribs, bolts, etc.

IfcBeamFallingPreventionDevice refers to the structure to prevent the falling of main girder during earthquake. Generally it is composed of shock proof block and retaining structure.

IfcCrossBrace refers to the transverse connection structure of arch rib. It mainly consists of members, plates and stiffening ribs.

#### 9.1.4 Others

(1) IfcRailing in IFC4 is used to describe the sidewalk railing, baskets on the pier and the inspection ladder in this schema.

(2) IfcReinforcingBar and IfcReinforcingMesh in IFC4 are used to describe the ReinforcingBar and ReinforcingMesh in this schema.

(3) IfcPile and IfcFooting in IFC4 are used to describe the pile foundation and footing in this schema.

(4) IfcTendon and IfcTendonAnchor in IFC4 are used to describe the prestressed tendon and anchorage in this schema. The description of prestressed bellows is in Section 4 of this document.

(5) IfcMechanicalFastener\BOLT and IfcMechanicalFastener\STUDSHEARCONNECTOR in IFC4 are used to describe bolts and shear studs in this schema.

(6) IfcFastener\WELD in IFC4 is used to describe the weld in this schema.

(7) IfcDiscreteAccessory\ANCHORPLATE in IFC4 is used to describe the anchor plate in this schema.

(8) The definition of cable slot is in Section 14 of this document.

(9) The definition of drainage pipe, chute and flow well is in Section 11 of this document.

## 9.2 Type Definition

### 9.2.1 IfcBridgeStructureTypeEnum

IfcBridgeStructureTypeEnum is an enumeration of bridge structure types, to define the different types of bridges from the perspective of the bridge's structural style.

#### Enumerated Item Definitions:

GIRDERBRIDGE;

ARCHBRIDGE;

RIGIDFRAMEBRIDGE;

CABLESTAYEDBRIDGE;

SUSPENSIONBRIDGE;

FRAME BRIDGE;

CULVERT;

USERDEFINED;

NOTDEFINED.

#### EXPRESS Specification:

TYPE IfcBridgeStructureTypeEnum = ENUMERATION OF

(GIRDERBRIDGE  
,ARCHBRIDGE  
,RIGIDFRAMEBRIDGE  
,CABLESTAYEDBRIDGE  
,SUSPENSIONBRIDGE  
,FRAME BRIDGE  
,CULVERT  
,USERDEFINED  
,NOTDEFINED);

END\_TYPE;

### 9.2.2 IfcBridgeStructurePartTypeEnum

IfcBridgeStructurePartTypeEnum defines the different types of bridge structure parts.

#### Enumerated Item Definitions:

GIRD;

ABUTMENT;

PIRE;

PYLONS;  
CABLES;  
ARCH;  
SUSPENDERS;  
FOUNDATION;  
SUSPENDED Tendons;  
BRIDGEFLOORSystem;  
USERDEFINED;  
NOTDEFINED.

**EXPRESS Specification:**

TYPE IfcBridgeStructurePartTypeEnum = ENUMERATION OF  
(GIRD  
,ABUTMENT  
,PIRE  
,PYLONS  
,CABLES  
,ARCH  
,SUSPENDERS  
,FOUNDATION  
,SUSPENDED Tendons  
,BRIDGEFLOORSystem  
,USERDEFINED  
,NOTDEFINED);  
END\_TYPE;

**9.2.3 IfcBridgeMemberTypeEnum**

IfcBridgeMemberTypeEnum defines the different types of bridge members.

**Enumerated Item Definitions:**

USERDEFINED;  
NOTDEFINED.

**EXPRESS Specification:**

TYPE IfcBridgeMemberTypeEnum = ENUMERATION OF  
(USERDEFINED  
,NOTDEFINED);  
END\_TYPE;

**9.2.4 IfcBridgeStiffeningRibTypeEnum**

IfcBridgeStiffeningRibTypeEnum defines the different types of bridge stiffening ribs.

**Enumerated Item Definitions:**

USERDEFINED;  
NOTDEFINED.

**EXPRESS Specification:**

TYPE IfcBridgeStiffeningRibTypeEnum = ENUMERATION OF  
(USERDEFINED  
,NOTDEFINED);  
END\_TYPE;

**9.2.5 IfcBridgeSlabTypeEnum**

IfcBridgeSlabTypeEnum defines the different types of bridge slabs.

**Enumerated Item Definitions:**

GUSSETPLATE;  
SPLICEPLATE;  
DECK;  
FOOTSLABS;  
USERDEFINED;  
NOTDEFINED.

**EXPRESS Specification:**

TYPE IfcBridgeSlabTypeEnum = ENUMERATION OF  
(GUSSETPLATE  
,SPLICEPLATE  
,DECK  
,FOOTSLABS  
,USERDEFINED  
,NOTDEFINED);  
END\_TYPE;

**9.2.6 IfcBridgeGirderSegmentTypeEnum**

IfcBridgeGirderSegmentTypeEnum defines the different types of bridge girder segments.

**Enumerated Item Definitions:**

USERDEFINED;  
NOTDEFINED.

**EXPRESS Specification:**

TYPE IfcBridgeGirderSegmentTypeEnum = ENUMERATION OF  
(USERDEFINED  
,NOTDEFINED);  
END\_TYPE;

**9.2.7 IfcBridgeGearBlockTypeEnum**

IfcBridgeGearBlockTypeEnum defines the different types of bridge gear blocks.

**Enumerated Item Definitions:**

USERDEFINED;

NOTDEFINED.

**EXPRESS Specification:**

```
TYPE IfcBridgeGearBlockTypeEnum = ENUMERATION OF
  (USERDEFINED
  ,NOTDEFINED);
END_TYPE;
```

**9.2.8 IfcBridgeBedStoneTypeEnum**

IfcBridgeBedStoneTypeEnum different the different types of bridge bed stones.

**Enumerated Item Definitions:**

USERDEFINED;

NOTDEFINED.

**EXPRESS Specification:**

```
TYPE IfcBridgeBedStoneTypeEnum = ENUMERATION OF
  (USERDEFINED
  ,NOTDEFINED);
END_TYPE;
```

**9.2.9 IfcBridgePierSegmentTypeEnum**

IfcBridgePierSegmentTypeEnum defines the different types of bridge pier segments.

**Enumerated Item Definitions:**

TOPCAP;

PIERBODY;

TRAY;

USERDEFINED;

NOTDEFINED.

**EXPRESS Specification:**

```
TYPE IfcBridgePierSegmentTypeEnum= ENUMERATION OF
  (TOPCAP
  ,PIERBODY
  ,TRAY
  ,USERDEFINED
  ,NOTDEFINED);
END_TYPE;
```

**9.2.10 IfcBridgeAbutmentSegmentTypeEnum**



IfcBridgeAbutmentSegmentTypeEnum defines the different types of bridge abutment segments.

**Enumerated Item Definitions:**

USERDEFINED;  
NOTDEFINED.

**EXPRESS Specification:**

```
TYPE IfcBridgeAbutmentSegmentTypeEnum= ENUMERATION OF
  (USERDEFINED
  ,NOTDEFINED);
END_TYPE;
```

### 9.2.11 IfcBridgePylonSegmentTypeEnum

IfcBridgePylonSegmentTypeEnum defines the different types of bridge pylon segments.

**Enumerated Item Definitions:**

USERDEFINED;  
NOTDEFINED.

**EXPRESS Specification:**

```
TYPE IfcBridgePylonSegmentTypeEnum= ENUMERATION OF
  (USERDEFINED
  ,NOTDEFINED);
END_TYPE;
```

### 9.2.12 IfcBridgeArchSegmentTypeEnum

IfcBridgeArchSegmentTypeEnum defines the different types of bridge arch segments.

**Enumerated Item Definitions:**

STEELPIPECONCRETEARCH;  
CONCRETEARCH;  
STEELBOXARCH;  
USERDEFINED;  
NOTDEFINED.

**EXPRESS Specification:**

```
TYPE IfcBridgeArchSegmentTypeEnum= ENUMERATION OF
  (STEELPIPECONCRETEARCH
  ,CONCRETEARCH
  ,STEELBOXARCH
  ,USERDEFINED
  ,NOTDEFINED);
END_TYPE;
```

### 9.2.13 IfcBridgeArchfootTypeEnum

IfcBridgeArchfootTypeEnum defines the different types of bridge arch foots.

#### Enumerated Item Definitions:

USERDEFINED;  
NOTDEFINED.

#### EXPRESS Specification:

```
TYPE IfcBridgeArchfootTypeEnum= ENUMERATION OF  
  ( USERDEFINED  
    ,NOTDEFINED);  
END_TYPE;
```

### 9.2.14 IfcBridgeStandColumnTypeEnum

IfcBridgeStandColumnTypeEnum defines the different types of bridge stand columns.

#### Enumerated Item Definitions:

USERDEFINED;  
NOTDEFINED.

#### EXPRESS Specification:

```
TYPE IfcBridgeStandColumnTypeEnum= ENUMERATION OF  
  ( USERDEFINED  
    ,NOTDEFINED);  
END_TYPE;
```

### 9.2.15 IfcBridgeSuspenderTypeEnum

IfcBridgeSuspenderTypeEnum defines the different types of bridge suspenders.

#### Enumerated Item Definitions:

USERDEFINED;  
NOTDEFINED.

#### EXPRESS Specification:

```
TYPE IfcBridgeSuspenderTypeEnum= ENUMERATION OF  
  ( USERDEFINED  
    ,NOTDEFINED);  
END_TYPE;
```

### 9.2.16 IfcBridgeCableTypeEnum

IfcBridgeCableTypeEnum defines the different types of bridge cables.

#### Enumerated Item Definitions:

USERDEFINED;  
NOTDEFINED.

**EXPRESS Specification:**

```
TYPE IfcBridgeCableTypeEnum= ENUMERATION OF
  ( USERDEFINED
    ,NOTDEFINED);
END_TYPE;
```

**9.2.17 IfcBridgeSuspendedTendonTypeEnum**

IfcBridgeSuspendedTendonTypeEnum defines the different types of bridge suspended tendons.

**Enumerated Item Definitions:**

```
USERDEFINED;
NOTDEFINED.
```

**EXPRESS Specification:**

```
TYPE IfcBridgeSuspendedTendonTypeEnum= ENUMERATION OF
  (USERDEFINED
    ,NOTDEFINED);
END_TYPE;
```

**9.2.18 IfcBridgeBearingTypeEnum**

IfcBridgeBearingTypeEnum defines the different types of bridge bearings from the perspective of the bearing's structural style.

**Enumerated Item Definitions:**

```
BASINRUBBERSUPPORT;
LAMINATEDRUBBERBEARING;
STEELBEARING;
USERDEFINED;
NOTDEFINED.
```

**EXPRESS Specification:**

```
TYPE IfcBridgeBearingTypeEnum= ENUMERATION OF
  (BASINRUBBERSUPPORT
    ,LAMINATEDRUBBERBEARING
    ,STEELBEARING
    ,USERDEFINED
    ,NOTDEFINED);
END_TYPE;
```

**9.2.19 IfcBridgeExpansionInstallationTypeEnum**

IfcBridgeExpansionInstallationTypeEnum defines the different types of bridge expansion installations.

**Enumerated Item Definitions:**

USERDEFINED;  
NOTDEFINED.

**EXPRESS Specification:**

TYPE IfcBridgeExpansionInstallationTypeEnum= ENUMERATION OF  
(USERDEFINED  
,NOTDEFINED);  
END\_TYPE;

**9.2.20 IfcBridgeProtectingWallTypeEnum**

IfcBridgeProtectingWallTypeEnum defines the different types of bridge protecting walls.

**Enumerated Item Definitions:**

USERDEFINED;  
NOTDEFINED.

**EXPRESS Specification:**

TYPE IfcBridgeProtectingWallTypeEnum= ENUMERATION OF  
(USERDEFINED  
,NOTDEFINED);  
END\_TYPE;

**9.2.21 IfcBridgeFrameSegmentTypeEnum**

IfcBridgeFrameSegmentTypeEnum defines the different types of bridge frame segments.

**Enumerated Item Definitions:**

USERDEFINED;  
NOTDEFINED.

**EXPRESS Specification:**

TYPE IfcBridgeFrameSegmentTypeEnum= ENUMERATION OF  
(USERDEFINED  
,NOTDEFINED);  
END\_TYPE;

**9.2.22 IfcBridgeWingWallTypeEnum**

IfcBridgeWingWallTypeEnum defines the different types of bridge wing walls.

**Enumerated Item Definitions:**

USERDEFINED;  
NOTDEFINED.

**EXPRESS Specification:**

TYPE IfcBridgeWingWallTypeEnum= ENUMERATION OF

```
(USERDEFINED
,NOTDEFINED);
END_TYPE;
```

### 9.2.23 IfcBridgeCulvertSegmentTypeEnum

IfcBridgeCulvertSegmentTypeEnum defines the different types of bridge culvert segments.

#### Enumerated Item Definitions:

```
USERDEFINED;
NOTDEFINED.
```

#### EXPRESS Specification:

```
TYPE IfcBridgeCulvertSegmentTypeEnum= ENUMERATION OF
(USERDEFINED
,NOTDEFINED);
END_TYPE;
```

### 9.2.24 IfcBridgeHatStoneTypeEnum

IfcBridgeHatStoneTypeEnum defines the different types of bridge hat stones.

#### Enumerated Item Definitions:

```
USERDEFINED;
NOTDEFINED.
```

#### EXPRESS Specification:

```
TYPE IfcBridgeHatStoneTypeEnum= ENUMERATION OF
(USERDEFINED
,NOTDEFINED);
END_TYPE;
```

### 9.2.25 IfcBridgeCopingTypeEnum

IfcBridgeCopingTypeEnum defines the different types of bridge copings.

#### Enumerated Item Definitions:

```
USERDEFINED;
NOTDEFINED.
```

#### EXPRESS Specification:

```
TYPE IfcBridgeCopingTypeEnum= ENUMERATION OF
(USERDEFINED
,NOTDEFINED);
END_TYPE;
```

### 9.2.26 IfcBridgeEmbeddedPartsFoundationTypeEnum

IfcBridgeEmbeddedPartsFoundationTypeEnum defines the different types of bridge

embedded parts foundation.

**Enumerated Item Definitions:**

USERDEFINED;  
NOTDEFINED.

**EXPRESS Specification:**

```
TYPE IfcBridgeEmbeddedPartsFoundationTypeEnum= ENUMERATION OF  
  ( USERDEFINED  
    ,NOTDEFINED);  
END_TYPE;
```

**9.2.27 IfcBridgeRefugePlatformTypeEnum**

IfcBridgeRefugePlatformTypeEnum defines the different types of bridge refuge platforms.

**Enumerated Item Definitions:**

USERDEFINED;  
NOTDEFINED.

**EXPRESS Specification:**

```
TYPE IfcBridgeRefugePlatformTypeEnum = ENUMERATION OF  
  (USERDEFINED  
    ,NOTDEFINED);  
END_TYPE;
```

**9.2.28 IfcBridgeTrussTypeEnum**

IfcBridgeTrussTypeEnum defines the different types of bridge trusses from the perspective of the truss's form.

**Enumerated Item Definitions:**

N-TRUSS;  
TRI-TRUSS;  
USERDEFINED;  
NOTDEFINED.

**EXPRESS Specification:**

```
TYPE IfcBridgeTrussTypeEnum= ENUMERATION OF  
  (N-TRUSS  
    ,TRI-TRUSS  
    ,USERDEFINED  
    ,NOTDEFINED);  
END_TYPE;
```

**9.2.29 IfcBridgeJointTypeEnum**

IfcBridgeJointTypeEnum defines the different types of bridge joints from the perspective of the joint's assembly method.

**Enumerated Item Definitions:**

INTEGRALJOINT;  
DISTRIBUTEDJOINT;  
USERDEFINED;  
NOTDEFINED.

**EXPRESS Specification:**

```
TYPE IfcBridgeJointTypeEnum= ENUMERATION OF
  (INTEGRALJOINT
  , DISTRIBUTEDJOINT
  ,USERDEFINED
  ,NOTDEFINED);
END_TYPE;
```

### 9.2.30 IfcBeamFallingPreventionDeviceTypeEnum

IfcBeamFallingPreventionDeviceTypeEnum defines the different types of beam falling prevention device.

**Enumerated Item Definitions:**

USERDEFINED;  
NOTDEFINED.

**EXPRESS Specification:**

```
TYPE IfcBeamFallingPreventionDeviceTypeEnum= ENUMERATION OF
  (USERDEFINED
  ,NOTDEFINED);
END_TYPE;
```

### 9.2.31 IfcCrossBraceTypeEnum

IfcCrossBraceTypeEnum defines the different types of cross braces according to the structural style of the cross brace.

**Enumerated Item Definitions:**

HORIZONTALBRACE;  
K-BRACE;  
USERDEFINED;  
NOTDEFINED.

**EXPRESS Specification:**

```
TYPE IfcCrossBraceTypeEnum= ENUMERATION OF
```

```

(HORIZONTALBRACE
,K-BRACE
,USERDEFINED
,NOTDEFINED);
END_TYPE;

```

### 9.3 Entity Definition

#### 9.3.1 IfcBridgeStructureElement

IfcBridgeStructureElement inherits from IfcCivilStructureElement, which is the supertype of all the spatial structure elements in the bridge domain.

##### EXPRESS Specification:

```

ENTITY IfcBridgeStructureElement
  ABSTRACT SUPERTYPE OF (ONEOF(IfcBridge, IfcBridgePart))
  SUBTYPE OF (IfcCivilStructureElement);
END_ENTITY;

```

#### 9.3.2 IfcBridge

IfcBridge defines a bridge which can be a single structure bridge or a composite bridge comprised of one or more single structure bridges.

**Table 9.1 IfcBridge spatial composition**

Spatial Composite	Description
IfcRailway	IfcBridge is part of IfcRailway.
IfcRailwayStation	IfcBridge is part of IfcRailwayStation.

**Table 9.2 IfcBridge spatial decomposition**

Spatial Parts	Description
IfcBridgePart	IfcBridge is composed of one or more IfcBridgeParts, but different types of bridges are composed of different types of IfcBridgePart, as shown in Table 9.4.
IfcBridge	IfcBridge can be composed of one or more IfcBridges.

**Table 9.3 Property sets for IfcBridge**

PredefinedType	Name
	Pset_BridgeCommon
	Pset_TechnicalStandard
ARCHBRIDGE	Pset_ArchBridge
RIGIDFRAMEBRIDGE	Pset_RigidBridge
CULVERT	Pset_Culvert

**Table 9.4 IfcBridge spatial decomposition and containment**

PredefinedType	Contained Bridge Parts	Contained Entities	Description
GIRDERBRIDGE	GIRD		GIRD is a component of GIRDERBRIDGE.



	ABUTMENT		ABUTMENT is a component of GIRDERBRIDGE.
	PIRE		PIRE is a component of GIRDERBRIDGE.
	FOUNDATION		FOUNDATION is a component of GIRDERBRIDGE.
	BRIDGEFLOORSYSTEM		BRIDGEFLOORSYSTEM is a component of GIRDERBRIDGE.
		IfcBridgeExpansion Installation	IfcBridgeExpansion Installation should be contained in GIRDERBRIDGE.
		IfcBridgeBearing	IfcBridgeBearing should be contained in GIRDERBRIDGE.
		IfcBeamFalling PreventionDevice	IfcBeamFalling PreventionDevice should be contained in GIRDERBRIDGE.
ARCHBRIDGE	GIRD		GIRD is a component of ARCHBRIDGE.
	ABUTMENT		ABUTMENT is a component of ARCHBRIDGE.
	PIRE		PIRE is a component of ARCHBRIDGE.
	FOUNDATION		FOUNDATION is a component of ARCHBRIDGE.
	BRIDGEFLOORSYSTEM		BRIDGEFLOORSYSTEM is a component of ARCHBRIDGE.
	ARCH		ARCH is a component of ARCHBRIDGE.
	SUSPENDERS		SUSPENDERS is a component of ARCHBRIDGE.
		IfcBridgeExpansion Installation	IfcBridgeExpansion Installation should be contained in ARCHBRIDGE.

		IfcBridgeBearing	IfcBridgeBearing should be contained in ARCHBRIDGE.
		IfcBeamFalling PreventionDevice	IfcBeamFalling PreventionDevice should be contained in ARCHBRIDGE.
		IfcBridgeArchfoot	IfcBridgeArchfoot should be contained in ARCHBRIDGE.
RIGIDFRAMEBRIDGE	GIRD		GIRD is a component of RIGIDFRAMEBRIDGE.
	ABUTMENT		ABUTMENT is a component of RIGIDFRAMEBRIDGE.
	PIRE		PIRE is a component of RIGIDFRAMEBRIDGE.
	FOUNDATION		FOUNDATION is a component of RIGIDFRAMEBRIDGE.
	BRIDGEFLOORSYSTEM		BRIDGEFLOORSYSTEM is a component of RIGIDFRAMEBRIDGE.
		IfcBridgeExpansion Installation	IfcBridgeExpansion Installation should be contained in RIGIDFRAMEBRIDGE.
		IfcBridgeBearing	IfcBridgeBearing should be contained in RIGIDFRAMEBRIDGE.
		IfcBeamFalling PreventionDevice	IfcBeamFalling PreventionDevice should be contained in RIGIDFRAMEBRIDGE.
CABLESTAYEDBRIDGE	GIRD		GIRD is a component of CABLESTAYEDBRIDGE.
	ABUTMENT		ABUTMENT is a component of CABLESTAYEDBRIDGE.
	PIRE		PIRE is a component of CABLESTAYEDBRIDGE.
	FOUNDATION		FOUNDATION is a component of CABLESTAYEDBRIDGE.

	BRIDGEFLOOR		BRIDGEFLOORSYSTEM is a component of CABLESTAYEDBRIDGE.
	PYLONS		PYLONS is a component of CABLESTAYEDBRIDGE.
	CABLES		CABLES is a component of CABLESTAYEDBRIDGE.
		IfcBridgeExpansion Installation	IfcBridgeExpansion Installation should be contained in CABLESTAYEDBRIDGE.
		IfcBridgeBearing	IfcBridgeBearing should be contained in CABLESTAYEDBRIDGE.
		IfcBeamFalling PreventionDevice	IfcBeamFalling PreventionDevice should be contained in CABLESTAYEDBRIDGE.
SUSPENSIONBRIDGE	GIRD		GIRD is a component of SUSPENSIONBRIDGE.
	ABUTMENT		ABUTMENT is a component of SUSPENSIONBRIDGE.
	PIRE		PIRE is a component of SUSPENSIONBRIDGE.
	FOUNDATION		FOUNDATION is a component of SUSPENSIONBRIDGE.
	BRIDGEFLOOR		BRIDGEFLOORSYSTEM is a component of SUSPENSIONBRIDGE.
	PYLONS		PYLONS is a component of SUSPENSIONBRIDGE.
	SUSPENDED TENDONS		SUSPENDED TENDONS is a component of SUSPENSIONBRIDGE.
		IfcBridgeExpansion Installation	IfcBridgeExpansion Installation should be contained in SUSPENSIONBRIDGE.

		IfcBridgeBearing	IfcBridgeBearing should be contained in SUSPENSIONBRIDGE.
		IfcBeamFalling PreventionDevice	IfcBeamFalling PreventionDevice should be contained in SUSPENSIONBRIDGE.
FRAMEBRIDGE	FOUNDATION		FOUNDATION is a component of FRAMEBRIDGE.
	BRIDGEFLOORSYSTEM		BRIDGEFLOORSYSTEM is a component of FRAMEBRIDGE.
		IfcBridgeFrameSegment	IfcBridgeFrameSegment should be contained in FRAMEBRIDGE.
		IfcBridgeWingWall	IfcBridgeWingWall should be contained in FRAMEBRIDGE.
CULVERT	FOUNDATION		FOUNDATION is a component of CULVERT.
		IfcBridgeCulvertSegment	IfcBridgeCulvertSegment should be contained in CULVERT.
		IfcBridgeWingWall	IfcBridgeWingWall should be contained in CULVERT.
		IfcBridgeHatStone	IfcBridgeHatStone should be contained in CULVERT.

**EXPRESS Specification:**

```

ENTITY IfcBridge
  SUBTYPE OF (IfcBridgeStructureElement);
  PreDefinedType: IfcBridgeStructureTypeEnum;
END_ENTITY;

```

**Attribute definitions:**

PreDefinedType: IfcBridge is subdivided into girder bridge, arch bridge, rigid frame bridge, cable-stayed bridge, suspension bridge, frame bridge and culvert from the perspective of structural style.

**9.3.3 IfcBridgePart**

IfcBridgePart refers to the various spatial parts of IfcBridge.

**Table 9.5 IfcBridgePart spatial composition**

Spatial Composite	Description
IfcBridge	IfcBridgePart is a component of IfcBridge.

**Table 9.6 IfcBridgePart spatial containment**

<b>PredefinedType</b>	<b>Contained Entities</b>	<b>Description</b>
GIRD	IfcBridgeMember	IfcBridgeMember can be contained in GIRD.
	IfcBridgeStiffeningRib	IfcBridgeStiffeningRib can be contained in GIRD.
	IfcBridgeSlab	IfcBridgeSlab can be contained in GIRD.
	IfcBridgeGirderSegment	IfcBridgeGirderSegment can be contained in GIRD.
ABUTMENT	IfcBridgeAbutmentSegment	IfcBridgeAbutmentSegment should be contained in ABUTMENT.
PIRE	IfcBridgePierSegment	IfcBridgePierSegment should be contained in PIRE.
PYLONS	IfcBridgePylonSegment	IfcBridgePylonSegment should be contained in PYLONS.
CABLES	IfcBridgeCable	IfcBridgeCable should be contained in CABLES.
ARCH	IfcBridgeArchSegment	IfcBridgeArchSegment should be contained in ARCH.
	IfcBridgeArchFoot	IfcBridgeArchFoot should be contained in ARCH.
	IfcCrossBrace	IfcCrossBrace should be contained in ARCH.
SUSPENDERS	IfcBridgeSuspender	IfcBridgeSuspender should be contained in SUSPENDERS.
FOUNDATION	IfcFooting	IfcFooting should be contained in FOUNDATION.
	IfcPile	IfcPile should be contained in FOUNDATION.
SUSPENDED TENDONS	IfcBridgeSuspendedTendon	IfcBridgeSuspendedTendon should be contained in SUSPENDED TENDONS.
BRIDGE FLOOR SYSTEM	IfcBridgeMember	IfcBridgeMember can be contained in BRIDGE FLOOR SYSTEM.
	IfcBridgeStiffeningRib	IfcBridgeStiffeningRib can be contained in BRIDGE FLOOR SYSTEM.
	IfcBridgeSlab	IfcBridgeSlab can be contained in BRIDGE FLOOR SYSTEM.
	IfcRailing	IfcRailing can be contained in

		BRIDGEFLOORSYSTEM.
	IfcBridgeRefugePlatform	IfcBridgeRefugePlatform can be contained in BRIDGEFLOORSYSTEM.

**Table 9.7 Property sets for IfcBridgePart**

PredefinedType	Name
GIRD	Pset_TechnicalIndex
ABUTMENT	Pset_Abutment
PIRE	Pset_BridgePier

**EXPRESS Specification:**

ENTITY IfcBridgePart

SUBTYPE OF (IfcBridgeStructureElement);

PreDefinedType: IfcBridgeStructurePartTypeEnum;

END\_ENTITY;

**Attribute definitions:**

PreDefinedType: IfcBridgePart includes GIRD, ABUTMENT, PIER, PYLONS, CABLES, ARCH, SUSPENDERS, FOUNDATION, SUSPENDED TENDONS and BRIDGEFLOORSYSTEM.

**9.3.4 IfcBridgeElement**

IfcBridgeElement is derived from the IfcCivilElement, which is the supertype of all physical elements in bridge engineering.

**Table 9.8 IfcBridgeElement contained in spatial structure**

Spatial Structure	Description
IfcBridge	IfcBridgeElement is a component of IfcBridge. Some of IfcBridgeElement can be directly contained in IfcBridge.
IfcBridgePart	IfcBridgeElement is a component of IfcBridgePart. Some of IfcBridgeElement should be contained in IfcBridgePart, but some of IfcBridgeElement can also be directly contained in IfcBridge.

**EXPRESS Specification:**

ENTITY IfcBridgeElement

ABSTRACT SUPERTYPE OF(ONEOF(IfcBridgeMember,IfcStiffeningRib,IfcBridgeSlab,IfcBridgeGirderSegment,IfcBridgeGearBlocks,IfcBridgeBedstone,IfcBridgePierSegment,IfcBridgeAbutmentSegment,IfcBridgePylon,IfcBridgeArchrib,IfcBridgeArchfoot,IfcBridgeStandColumn,IfcBridgeSuspender,IfcBridgeCable,IfcBridgeSuspendedTendon,IfcBridgeBearing,IfcBridgeExpansionInstallation,IfcBridgeProtectingWall,IfcBridgeFrameSegment,IfcBridgeWingWall,IfcBridgeCulvertSegment,IfcBridgeHatStone,IfcBridgeCoping,IfcBridgeEmbeddedPartsFoundation,IfcBridgeRefugePlatform))

SUBTYPE OF (IfcCivilElement);

END\_ENTITY;

**9.3.5 IfcBridgeMember**

IfcBridgeMember mainly refers to the members comprising the structure, such as truss member, longitudinal beam, cross beam, etc.

**Table 9.9 IfcBridgeMember contained in spatial structure**

Spatial Structure	Description
IfcBridgePart\GIRD	IfcBridgeMember can be contained in IfcBridgePart\GIRD.
IfcBridgePart\PYLONS	IfcBridgeMember can be contained in IfcBridgePart\PYLONS.
IfcBridgePart\ARCH	IfcBridgeMember can be contained in IfcBridgePart\ARCH.
IfcBridgePart\BRIDGEFLOOR SYSTEM	IfcBridgeMember can be contained in IfcBridgePart\BRIDGEFLOORSYSTEM.

**EXPRESS Specification:**

ENTITY IfcBridgeMember

SUBTYPE OF (IfcBridgeElement);

PreDefinedType: IfcBridgeMemberTypeEnum;

END\_ENTITY;

**Attribute definitions:**

PreDefinedType: Currently it only includes USERDEFINED and NOTDEFINED.

**9.3.6 IfcBridgeStiffeningRib**

IfcBridgeStiffeningRib mainly refers to U-type rib, plate rib and other stiffening structures.

**Table 9.10 IfcBridgeStiffeningRib contained in spatial structure**

Spatial Structure	Description
IfcBridgePart\GIRD	IfcBridgeStiffeningRib can be contained in IfcBridgePart\GIRD.
IfcBridgePart\PYLONS	IfcBridgeStiffeningRib can be contained in IfcBridgePart\PYLONS.
IfcBridgePart\ARCH	IfcBridgeStiffeningRib can be contained in IfcBridgePart\ARCH.
IfcBridgePart\BRIDGEFLOOR SYSTEM	IfcBridgeStiffeningRib can be contained in IfcBridgePart\BRIDGEFLOORSYSTEM.

**EXPRESS Specification:**

ENTITY IfcBridgeStiffeningRib

SUBTYPE OF (IfcBridgeElement);

PreDefinedType: IfcBridgeStiffeningRibTypeEnum;

END\_ENTITY;

**Attribute definitions:**

PreDefinedType: Currently it only includes USERDEFINED and NOTDEFINED.

**9.3.7 IfcBridgeSlab**

IfcBridgeSlab mainly refers to gusset plate, bridge deck, splice plate, cantilever plate and pavement slab, and their thickness can be changed.

**Table 9.11 IfcBridgeSlab contained in spatial structure**

Spatial Structure	Description
IfcBridgePart\GIRD	IfcBridgeSlab can be contained in IfcBridgePart\GIRD.
IfcBridgePart\PYLONS	IfcBridgeSlab can be contained in IfcBridgePart\PYLONS.
IfcBridgePart\ARCH	IfcBridgeSlab can be contained in IfcBridgePart\ARCH.
IfcBridgePart\BRIDGEFLOOR SYSTEM	IfcBridgeSlab can be contained in IfcBridgePart\BRIDGEFLOORSYSTEM.

**EXPRESS Specification:**

```
ENTITY IfcBridgeSlab
  SUBTYPE OF (IfcBridgeElement);
  PreDefinedType: IfcBridgeSlabTypeEnum;
END_ENTITY;
```

**Attribute definitions:**

PreDefinedType: It currently includes gusset plate, splice plate, bridge deck and pavement slab.

**9.3.8 IfcBridgeGirderSegment**

IfcBridgeGirderSegment is a component of IfcBridgePart\GIRD.

**Table 9.12 IfcBridgeGirderSegment contained in spatial structure**

Spatial Structure	Description
IfcBridgePart\GIRD	IfcBridgeGirderSegment is a component of IfcBridgePart\GIRD.

**Table 9.13 IfcBridgeGirderSegment decomposition**

Parts	Description
IfcBridgeMember	IfcBridgeMember can be contained in IfcBridgeGirderSegment.
IfcBridgeStiffeningRib	IfcBridgeStiffeningRib can be contained in IfcBridgeGirderSegment.
IfcBridgeSlab	IfcBridgeSlab can be contained in IfcBridgeGirderSegment.
IfcBridgeGearBlocks	IfcBridgeGearBlocks can be contained in IfcBridgeGirderSegment.

**EXPRESS Specification:**

```
ENTITY IfcBridgeGirderSegment
  SUBTYPE OF (IfcBridgeElement);
  PreDefinedType: IfcBridgeGirderSegmentTypeEnum;
END_ENTITY;
```

**Attribute definitions:**

PreDefinedType: It currently only includes USERDEFINED and NOTDEFINED.

**9.3.9 IfcBridgeGearBlock**

IfcBridgeGearBlock refers to the wedge structure to anchor the prestressed steel strand.



**Table 9.14 IfcBridgeGearBlock contained in spatial structure**

Spatial Structure	Description
IfcBridgePart\GIRD	IfcBridgeGearBlock is a component of IfcBridgePart\GIRD.

**EXPRESS Specification:**

ENTITY IfcBridgeGearBlock  
 SUBTYPE OF (IfcBridgeElement);  
 PreDefinedType: IfcBridgeGearBlockTypeEnum;  
 END\_ENTITY;

**Attribute definitions:**

PreDefinedType: It currently only includes USERDEFINED and NOTDEFINED.

**9.3.10 IfcBridgeBedstone**

IfcBridgeBedstone refers to the structure placed on the top of the pier or abutment to support the bearing.

**Table 9.15 IfcBridgeBedstone contained in spatial structure**

Spatial Structure	Description
IfcBridgePart\PIRE	IfcBridgeBedstone should be contained in IfcBridgePart\PIRE.
IfcBridgePart\ABUTMENT	IfcBridgeBedstone should be contained in IfcBridgePart\ABUTMENT.

**EXPRESS Specification:**

ENTITY IfcBridgeBedstone  
 SUBTYPE OF (IfcBridgeElement);  
 PreDefinedType: IfcBridgeBedstoneTypeEnum;  
 END\_ENTITY;

**Attribute definitions:**

PreDefinedType: It currently only includes USERDEFINED and NOTDEFINED.

**9.3.11 IfcBridgePierSegment**

IfcBridgePierSegment refers to the pier shaft segment, the top cap and tray.

**Table 9.16 IfcBridgePierSegment contained in spatial structure**

Spatial Structure	Description
IfcBridgePart\PIRE	IfcBridgePierSegment is a component of IfcBridgePart\PIRE.

**EXPRESS Specification:**

ENTITY IfcBridgePierSegment  
 SUBTYPE OF (IfcBridgeElement);  
 PreDefinedType: IfcBridgePierSegmentTypeEnum;  
 END\_ENTITY;

**Attribute definitions:**

PreDefinedType: It currently includes the pier shaft segment, the top cap and tray.

**9.3.12 IfcBridgeAbutmentSegment**

IfcBridgeAbutmentSegment refers to the component of the abutment.

**Table 9.17 IfcBridgeAbutmentSegment contained in spatial structure**

Spatial Structure	Description
IfcBridgePart\Abutment	IfcBridgeAbutmentSegment is a component of IfcBridgePart\Abutment.

**EXPRESS Specification:**

ENTITY IfcBridgeAbutmentSegment  
 SUBTYPE OF (IfcBridgeElement);  
 PreDefinedType: IfcBridgeAbutmentSegmentTypeEnum;  
 END\_ENTITY;

**Attribute definitions:**

PreDefinedType: It currently only includes USERDEFINED and NOTDEFINED.

**9.3.13 IfcBridgePylonSegment**

IfcBridgePylonSegment refers to the component of the pylon.

**Table 9.18 IfcBridgePylonSegment contained in spatial structure**

Spatial Structure	Description
IfcBridgePart\PYLONS	IfcBridgePylonSegment is a component of IfcBridgePart\PYLONS.

**EXPRESS Specification:**

ENTITY IfcBridgePylonSegment  
 SUBTYPE OF (IfcBridgeElement);  
 PreDefinedType: IfcBridgePylonSegmentTypeEnum;  
 END\_ENTITY;

**Attribute definitions:**

PreDefinedType: It currently only includes USERDEFINED and NOTDEFINED.

**9.3.14 IfcBridgeArchSegment**

IfcBridgeArchSegment refers to the component of the bridge arch.

**Table 9.19 IfcBridgeArchSegment contained in spatial structure**

Spatial Structure	Description
IfcBridgePart\ARCH	IfcBridgeArchSegment is a component of IfcBridgePart\ARCH.

**EXPRESS Specification:**

ENTITY IfcBridgeArchSegment  
 SUBTYPE OF (IfcBridgeElement);  
 PreDefinedType: IfcBridgeArchSegmentTypeEnum;  
 END\_ENTITY;

**Attribute definitions:**

PreDefinedType: It currently includes STEELPIPECONCRETEARCH, CONCRETEARCH and STEELBOXARCH.

**9.3.15 IfcBridgeArchFoot**

IfcBridgeArchFoot refers to the structure to support the arch rib and connect the foundation or main girder to the arch rib.

**Table 9.20 IfcBridgeArchFoot contained in spatial structure**

Spatial Structure	Description
IfcBridge\ARCHBRIDGE	IfcBridgeArchFoot is a component of IfcBridge\ARCHBRIDGE.

**EXPRESS Specification:**

ENTITY IfcBridgeArchFoot  
 SUBTYPE OF (IfcBridgeElement);  
 PreDefinedType: IfcBridgeArchFootTypeEnum;  
 END\_ENTITY;

**Attribute definitions:**

PreDefinedType: It currently only includes USERDEFINED and NOTDEFINED.

**9.3.16 IfcBridgeStandColumn**

IfcBridgeStandColumn refers to the structure on the arch rib to support the main girder.

**Table 9.21 IfcBridgeStandColumn contained in spatial structure**

Spatial Structure	Description
IfcBridge\ARCHBRIDGE	IfcBridgeStandColumn is a component of IfcBridge\ARCHBRIDGE.

**EXPRESS Specification:**

ENTITY IfcBridgeStandColumn  
 SUBTYPE OF (IfcBridgeElement);  
 PreDefinedType: IfcBridgeStandColumnTypeEnum;  
 END\_ENTITY;

**Attribute definitions:**

PreDefinedType: It currently only includes USERDEFINED and NOTDEFINED.

**9.3.17 IfcBridgeSuspender**

IfcBridgeSuspender: refers to the structure to connect the suspension cable or the arch rib with the bridge floor system.

**Table 9.22 IfcBridgeSuspender contained in spatial structure**

Spatial Structure	Description
IfcBridgePart\SUSPENDERS	IfcBridgeSuspender is a component of IfcBridgePart\SUSPENDERS.

**EXPRESS Specification:**

ENTITY IfcBridgeSuspender  
 SUBTYPE OF (IfcBridgeElement);  
 PreDefinedType: IfcBridgeSuspenderTypeEnum;  
 END\_ENTITY;

**Attribute definitions:**

PreDefinedType: It currently includes USERDEFINED and NOTDEFINED.

### 9.3.18 IfcBridgeCable

IfcBridgeCable refers to the structure to connect the pylon with the bridge floor system.

**Table 9.23 IfcBridgeCable contained in spatial structure**

Spatial Structure	Description
IfcBridgePart\CABLES	IfcBridgeCable is a component of IfcBridgePart\CABLES.

**Table 9.24 Property sets for IfcBridgeCable**

PredefinedType	Name
	Pset_BridgeCable

**EXPRESS Specification:**

ENTITY IfcBridgeCable  
 SUBTYPE OF (IfcBridgeElement);  
 PreDefinedType: IfcBridgeCableTypeEnum;  
 END\_ENTITY;

**Attribute definitions:**

PreDefinedType: It currently includes USERDEFINED and NOTDEFINED.

### 9.3.19 IfcBridgeSuspendedTendon

IfcBridgeSuspendedTendon refers to the single suspension cable, which comprises steel wire, sheath, etc.

**Table 9.25 IfcBridgeSuspendedTendon contained in spatial structure**

Spatial Structure	Description
IfcBridgePart\SUSPENDED TendONS	IfcBridgeSuspendedTendon is a component of IfcBridgePart\SUSPENDED TendONS.

**EXPRESS Specification:**

ENTITY IfcBridgeSuspendedTendon  
 SUBTYPE OF (IfcBridgeElement);  
 PreDefinedType: IfcBridgeSuspendedTendonTypeEnum;  
 END\_ENTITY;

**Attribute definitions:**

PreDefinedType: It only includes USERDEFINED and NOTDEFINED.

### 9.3.20 IfcBridgeBearing

IfcBridgeBearing refers to a structure to support the main girder and transfer the load from the superstructure to the bridge pier.

**Table 9.26 IfcBridgeBearing contained in spatial structure**

Spatial Structure	Description
IfcBridge	IfcBridgeBearing is a component of IfcBridge.

**Table 9.27 Property sets for IfcBridgeBearing**

PredefinedType	Name
	Pset_BridgeBearing

**EXPRESS Specification:**

ENTITY IfcBridgeBearing  
 SUBTYPE OF (IfcBridgeElement);  
 PreDefinedType: IfcBridgeBearingTypeEnum;  
 END\_ENTITY;

**Attribute definitions:**

PreDefinedType: IfcBridgeBearing is subdivided into BASINRUBBERSUPPORT, LAMINATEDRUBBERBEARING and STEELBEARING.

**9.3.21 IfcBridgeExpansionInstallation**

IfcBridgeExpansionInstallation refers to the structure installed on between two main girders to facilitate the vehicle smoothly pass the bridge deck and to meet the deformation of the upper structure of the bridge. It is comprised of rubber and steel parts.

**Table 9.28 IfcBridgeExpansionInstallation contained in spatial structure**

Spatial Structure	Description
IfcBridge	IfcBridgeExpansionInstallation is a component of IfcBridge.

**Table 9.29 Property sets for IfcBridgeExpansionInstallation**

PredefinedType	Name
	Pset_ExpansionInstallation

**EXPRESS Specification:**

ENTITY IfcBridgeExpansionInstallation  
 SUBTYPE OF (IfcBridgeElement);  
 PreDefinedType: IfcBridgeExpansionInstallationTypeEnum;  
 END\_ENTITY;

**Attribute definitions:**

PreDefinedType: It currently includes USERDEFINED and NOTDEFINED.

**9.3.22 IfcBridgeProtectingWall**

IfcBridgeProtectingWall refers to the structure located on the bridge deck to protect the pedestrians and to retain ballast.

**Table 9.30 IfcBridgeProtectingWall contained in spatial structure**

Spatial Structure	Description
IfcBridgePart\BRIDGEFLOORSYSTEM	IfcBridgeProtectingWall is a component of IfcBridgePart\BRIDGEFLOORSYSTEM.

**EXPRESS Specification:**

ENTITY IfcBridgeProtectingWall  
 SUBTYPE OF (IfcBridgeElement);

PreDefinedType: IfcBridgeProtectingWallTypeEnum;  
 END\_ENTITY;

**Attribute definitions:**

PreDefinedType: It currently includes USERDEFINED and NOTDEFINED.

**9.3.23 IfcFrameSegment**

IfcFrameSegment refers to a segment of a frame bridge.

**Table 9.31 IfcFrameSegment contained in spatial structure**

Spatial Structure	Description
IfcBridge\FRAMEBRIDGE	IfcFrameSegment is a component of IfcBridge\FRAMEBRIDGE.

**EXPRESS Specification:**

ENTITY IfcFrameSegment  
 SUBTYPE OF (IfcBridgeElement);  
 PreDefinedType: IfcFrameSegmentWallTypeEnum;  
 END\_ENTITY;

**Attribute definitions:**

PreDefinedType: It currently includes USERDEFINED and NOTDEFINED.

**9.3.24 IfcBridgeWingWall**

IfcBridgeWingWall refers to the structure on the inlet and outlet of culvert and a frame bridge to ensure the two sides of the embankment slope stability and to guide the river.

**Table 9.32 IfcBridgeWingWall contained in spatial structure**

Spatial Structure	Description
IfcBridge\FRAMEBRIDGE	IfcBridgeWingWall is a component of IfcBridge\FRAMEBRIDGE.
IfcBridge\CULVERT	IfcBridgeWingWall is a component of IfcBridge\CULVERT.

**EXPRESS Specification:**

ENTITY IfcBridgeWingWall  
 SUBTYPE OF (IfcBridgeElement);  
 PreDefinedType: IfcBridgeWingWallTypeEnum;  
 END\_ENTITY;

**Attribute definitions:**

PreDefinedType: It currently includes USERDEFINED and NOTDEFINED.

**9.3.25 IfcBridgeCulvertSegment**

IfcBridgeCulvertSegment refers to a segment of a culvert.

**Table 9.33 IfcBridgeCulvertSegment contained in spatial structure**

Spatial Structure	Description
IfcBridge\CULVERT	IfcBridgeCulvertSegment is a component of IfcBridge\CULVERT.

**EXPRESS Specification:**

ENTITY IfcBridgeCulvertSegment  
 SUBTYPE OF (IfcBridgeElement);  
 PreDefinedType: IfcBridgeCulvertSegmentTypeEnum;  
 END\_ENTITY;

**Attribute definitions:**

PreDefinedType: It currently includes USERDEFINED and NOTDEFINED.

**9.3.26 IfcBridgeHatStone**

IfcBridgeHatStone refers to the structure on the end of wall of the culvert used to support the subgrade filling material.

**Table 9.34 IfcBridgeHatStone contained in spatial structure**

Spatial Structure	Description
IfcBridge\CULVERT	IfcBridgeHatStone is a component of IfcBridge\CULVERT.

**EXPRESS Specification:**

ENTITY IfcBridgeHatStone  
 SUBTYPE OF (IfcBridgeElement);  
 PreDefinedType: IfcBridgeHatStoneTypeEnum;  
 END\_ENTITY;

**Attribute definitions:**

PreDefinedType: It currently includes USERDEFINED and NOTDEFINED.

**9.3.27 IfcBridgeCoping**

IfcBridgeCoping refers to the structure set on the top of the frame or the double column pier to support, distribute and transfer the load of the upper structure, also known as cap beam.

**Table 9.35 IfcBridgeCoping contained in spatial structure**

Spatial Structure	Description
IfcBridgePart\PIRE	IfcBridgeCoping is a component of IfcBridgePart\PIRE.

**EXPRESS Specification:**

ENTITY IfcBridgeCoping  
 SUBTYPE OF (IfcBridgeElement);  
 PreDefinedType: IfcBridgeCopingTypeEnum;  
 END\_ENTITY;

**Attribute definitions:**

PreDefinedType: It currently includes USERDEFINED and NOTDEFINED.

**9.3.28 IfcBridgeEmbeddedPartsFoundation**

IfcBridgeEmbeddedPartsFoundation refers to the joint structure placed on bridge deck or piers to connect other structures.

**Table 9.36 IfcBridgeEmbeddedPartsFoundation contained in spatial structure**

Spatial Structure	Description
IfcBridgePart\BRIDGEFLOORSYSTEM	IfcBridgeEmbeddedPartsFoundation is a component of IfcBridgePart\BRIDGEFLOORSYSTEM.

**EXPRESS Specification:**

ENTITY IfcBridgeEmbeddedPartsFoundation  
 SUBTYPE OF (IfcBridgeElement);  
 PreDefinedType: IfcBridgeEmbeddedPartsFoundationTypeEnum;  
 END\_ENTITY;

**Attribute definitions:**

PreDefinedType: It only includes USERDEFINED and NOTDEFINED.

**9.3.29 IfcBridgeRefugePlatform**

IfcBridgeRefugePlatform refers to the platform on the bridge for maintenance personnel to avoid the train.

**Table 9.37 IfcBridgeRefugePlatform contained in spatial structure**

Spatial Structure	Description
IfcBridgePart\BRIDGEFLOORSYSTEM	IfcBridgeRefugePlatform is a component of IfcBridgePart\BRIDGEFLOORSYSTEM

**EXPRESS Specification:**

ENTITY IfcBridgeRefugePlatform  
 SUBTYPE OF (IfcBridgeElement);  
 PreDefinedType: IfcBridgeRefugePlatformTypeEnum;  
 END\_ENTITY;

**Attribute definitions:**

PreDefinedType: It only includes USERDEFINED and NOTDEFINED.

**9.3.30 IfcBridgeElementAssembly**

IfcBridgeElementAssembly is derived from the IfcCivilElementAssembly, which is the supertype of all element assemblies in bridge engineering.

**Table 9.38 IfcBridgeElementAssembly contained in spatial structure**

Spatial Structure	Description
IfcBridge	IfcBridgeElementAssembly is a component of IfcBridge.
IfcBridgePart	IfcBridgeElementAssembly is a component of IfcBridgePart.

**EXPRESS Specification:**

ENTITY IfcBridgeElementAssembly  
 ABSTRACT SUPERTYPE OF (ONEOF (IfcBridgeTruss,IfcBridgeJoint,  
 IfcBeamFallingPreventionDevice, IfcCrossBrace))  
 SUBTYPE OF (IfcCivilElementAssembly);  
 END\_ENTITY;

**9.3.31 IfcBridgeTruss**



IfcBridgeTruss refers to a truss structure comprised of members and is a part of a steel truss bridge.

**Table 9.39 IfcBridgeTruss entity composition**

PredefinedType	Contained Entities	Description
	IfcBridgeMember	IfcBridgeMember can be contained in IfcBridgeTruss.
	IfcBridgeStiffeningRib	IfcBridgeStiffeningRib can be contained in IfcBridgeTruss.
	IfcBridgeSlab	IfcBridgeSlab can be contained in IfcBridgeTruss.
	IfcBridgeJoint	IfcBridgeJoint can be contained in IfcBridgeTruss.

**Table 9.40 IfcBridgeTruss contained in spatial structure**

Spatial Structure	Description
IfcBridgePart\GIRD	IfcBridgeTruss is a component of IfcBridgePart\GIRD.

**EXPRESS Specification:**

ENTITY IfcBridgeTruss  
 SUBTYPE OF (IfcBridgeElementAssembly);  
 PreDefinedType: IfcBridgeTrussTypeEnum;  
 END\_ENTITY;

**Attribute definitions:**

PreDefinedType: It includes N-TRUSS and TRI-TRUSS.

**9.3.32 IfcBridgeJoint**

IfcBridgeJoint refers to the structure to connect the members of truss.

**Table 9.41 IfcBridgeJoint entity composition**

PredefinedType	Contained Entities	Description
	IfcBridgeStiffeningRib	IfcBridgeStiffeningRib can be contained in IfcBridgeJoint.
	IfcBridgeSlab	IfcBridgeSlab can be contained in IfcBridgeJoint.

**Table 9.42 IfcBridgeJoint contained in spatial structure**

Spatial Structure	Description
IfcBridgePart\GIRD	IfcBridgeJoint is a component of IfcBridgePart\GIRD.

**EXPRESS Specification:**

ENTITY IfcBridgeJoint  
 SUBTYPE OF (IfcBridgeElementAssembly);  
 PreDefinedType: IfcBridgeJointTypeEnum;  
 END\_ENTITY;

**Attribute definitions:**

PreDefinedType: It includes INTEGRALJOINT and DISTRIBUTEDJOINT.

### 9.3.33 IfcBeamFallingPreventionDevice

IfcBeamFallingPreventionDevice refers to the structure to prevent the falling of main girder during earthquake.

**Table 9.43 IfcBeamFallingPreventionDevice entity composition**

PredefinedType	Contained Entities	Description
	IfcBridgeMember	IfcBridgeMember can be contained in IfcBeamFallingPreventionDevice.
	IfcBridgeStiffeningRib	IfcBridgeStiffeningRib can be contained in IfcBeamFallingPreventionDevice.
	IfcBridgeSlab	IfcBridgeSlab can be contained in IfcBeamFallingPreventionDevice.

**Table 9.44 IfcBeamFallingPreventionDevice contained in spatial structure**

Spatial Structure	Description
IfcBridge	IfcBeamFallingPreventionDevice is a component of IfcBridge.

**EXPRESS Specification:**

ENTITY IfcBeamFallingPreventionDevice  
 SUBTYPE OF (IfcBridgeElementAssembly);  
 PreDefinedType: IfcBeamFallingPreventionDeviceTypeEnum;  
 END\_ENTITY;

**Attribute definitions:**

PreDefinedType: It currently includes USERDEFINED and NOTDEFINED.

### 9.3.34 IfcCrossBrace

IfcCrossBrace refers to the transverse connection structure of arch rib.

**Table 9.45 IfcCrossBrace entity composition**

PredefinedType	Contained Entities	Description
	IfcBridgeMember	IfcBridgeMember can be contained in IfcCrossBrace.
	IfcBridgeStiffeningRib	IfcBridgeStiffeningRib can be contained in IfcCrossBrace.
	IfcBridgeSlab	IfcBridgeSlab can be contained in IfcCrossBrace.

**Table 9.46 IfcCrossBrace contained in spatial structure**

Spatial Structure	Description
IfcBridgePart\ARCH	IfcCrossBrace is a component of IfcBridgePart\ARCH.

**EXPRESS Specification:**

ENTITY IfcCrossBrace  
 SUBTYPE OF (IfcBridgeElementAssembly);

PreDefinedType: IfcCrossBraceTypeEnum;  
END\_ENTITY;

**Attribute definitions:**

PreDefinedType: It only includes USERDEFINED and NOTDEFINED.

**9.4 Property Set Definition**

**9.4.1 Pset\_BridgeCommon**

Name: Pset\_BridgeCommon

Applicable Entities: IfcBridge

Description: Common property set of bridge.

Property Definitions: See Table 9.47.

**Table 9.47 Property definitions of Pset\_BridgeCommon**

Name	Type	Description
Name	TypePropertySingle Value/IfcLabel	Name of a bridge.
BridgeArrangement	TypePropertySingle Value/IfcLabel	Arrangement of a bridge.
CenterKilometerage	TypePropertySingle Value/IfcLabel	Center kilometer age of a bridge.
Number	TypePropertySingle Value/IfcLabel	Number of a bridge.
Span	TypePropertySingle Value/IfcLabel	The length of a bridge.
ConstructionMethod	TypePropertyEnumeratedValue/ PEnum_ConstructionMethod: CantileveredConcretingMethod, SegmentCantileveredAssemblingMethod, MobileFormMethod, FullSupportingFrameMethod, IncrementalLaunchingConstructionMethod, CantileveredAssemblingMethod, RotationConstructionMethod, FabricationAndErectionMethod, JackingEngineeringMethod.	Construction method of a bridge, including Cantilevered Concreting Method, Segment Cantilevered Assembling Method, Mobile Form Method, Full Supporting Frame Method, Incremental Launching Construction Method, Cantilevered Assembling Method, Rotation Construction Method, Fabrication And Erection Method and Jacking Engineering Method.
DrainForm	TypePropertyEnumeratedValue/ PEnum_DrainForm: DirectDriange, ConcentratedDrainage	Drain form, including DirectDriange and ConcentratedDrainage.
Scale	TypePropertyEnumeratedValue/PEnum_Scale:extra-long bridge,major bridge,medium bridge,minor bridge	Scale of a bridge. It is classified by the length of a bridge, including extra-long bridge, major bridge, medium bridge and minor bridge.

**9.4.2 Pset\_TechnicalStandard**

Name: Pset\_TechnicalStandard

Applicable Entities: IfcBridge

Description: Property set of technical standard of a bridge.

Property Definitions: See Table 9.48.

**Table 9.48 Property definitions of Pset\_TechnicalStandard**

Name	Type	Description
DesignSpeed	TypePropertySingleValue/IfcLinearVelocityMeasure/m/s	Design speed.
MaximumDistanceBetweenCentersOfTracks	TypePropertySingleValue/IfcPositiveLengthMeasure/m	Maximum distance between centers of tracks.
MinimumDistanceBetweenCentersOfTracks	TypePropertySingleValue/IfcPositiveLengthMeasure/m	Minimum distance between centers of tracks.
RoadLevel	TypePropertyEnumeratedValue/PEnum_RoadLevel: Highway,First-ClassHighway,Secondary-ClassHighway,Third-ClassHighway,Forth-ClassHighway	Road level. It includes Highway, First-Class Highway, Secondary-Class Highway, Third-Class Highway and Forth-Class Highway.
HighestDrivingSpeedOfCar	TypePropertySingleValue/IfcLinearVelocityMeasure/m/s	The highest driving speed of a car.
DesignFloodFrequency	TypePropertyEnumeratedValue/PEnum_DesignFloodFrequency : 1/100,1/50,1/30,1/20,1/10	Design flood frequency. It includes 1/100, 1/50, 1/30, 1/20 and 1/10.
NavigationLevel	TypePropertyEnumeratedValue/PEnum_NavigationLevel: I, II, III,IV, V ,VI,VII	Navigation Level. It includes I, II, III, IV, V, VI and VII.

#### 9.4.3 Pset\_TechnicalIndex

Name: Pset\_TechnicalIndex

Applicable Entities: IfcBridgePart\GIRD

Description: Property set of technical index of a bridge.

Property Definitions: See Table 9.49.

**Table 9.49 Property definitions of Pset\_TechnicalIndex**

Name	Type	Description
TheRatioOfDeflectionToSpan	TypePropertySingleValue/IfcRatioMeasure	The ratio of deflection to span.
RotationAngleAtBeamEnd	TypePropertySingleValue/IfcPositivePlaneAngleMeasure/rad	Rotation angle at beam end.
ResidualCreep	TypePropertySingleValue/IfcNonNegativeLengthMeasure/m	The residual deformation of creep.
Deflection	TypePropertySingleValue/IfcNonNegativeLengthMeasure/m	Deflection.
TheRatioOfHeightToSpan	TypePropertySingleValue/IfcRatioMeasure	The ratio of height to span.

#### 9.4.4 Pset\_Bellow

Name: Pset\_Bellow

Applicable Entities: IfcTendonBellow

Description: Common property set of tendon bellows.

Property definitions: See Table 9.50.

**Table 9.50 Property definitions of Pset\_Bellow**

Name	Type	Description
Material	TypePropertyEnumeratedValue/PEnum_Material : Metal, Plastic	Material of bellows, including metal and plastic.
Specifications	TypePropertySingleValue/IfcLabel	Specifications of bellows.

#### 9.4.5 Pset\_BridgeCable

Name: Pset\_BridgeCable

Applicable Entities: IfcBridgeCable

Description: Common property set of bridge cables.

Property Definitions: See Table 9.51.

**Table 9.51 Property definitions of Pset\_Cable**

Name	Type	Description
LengthError	TypePropertySingleValue/IfcLengthMeasure/m	The length between the actual length and designed length.
SuperTensionForce	TypePropertySingleValue/IfcForceMeasure/N	The force beyond the design force.
CableTensionForce	TypePropertySingleValue/IfcForceMeasure/N	Tension force of the cable.
WithdrawalValueOfChillCastingAnchorPlate	TypePropertySingleValue/IfcLengthMeasure/m	Withdrawal value of chill casting anchor plate.
DeadLoadBreakingForce	TypePropertySingleValue/IfcForceMeasure/N	The breaking force of cable on dead load.
NominalBreakingForce	TypePropertySingleValue/IfcForceMeasure/N	The nominal breaking force of cable.
DeadLoadBreakingElongation	TypePropertySingleValue/IfcRatioMeasure	The elongation value when the cable breaking.
TensileElasticModulus	TypePropertySingleValue/IfcPressureMeasure/Pa	Tensile elastic modulus.
SafetyCoefficient	TypePropertySingleValue/IfcReal	Safety coefficient.

#### 9.4.6 Pset\_ArchBridge

Name: Pset\_ArchBridge

Applicable Entities: IfcBridge\ARCHBRIDGE

Description: Common property set of arch bridges.

Property Definitions: See Table 9.52.

**Table 9.52 Property definitions of Pset\_ArchBridge**

Name	Type	Description
StructureForm	TypePropertyEnumeratedValue/PEnum_StructureForm:UpperBearing,MediumBearing,UnderBearing	Structure Form of arch bridges, including UpperBearing, MediumBearing and UnderBearing.
HorizontalThrust	TypePropertyEnumeratedValue/PEnum_HorizontalThrust:YES,NON	Indicates whether there is a horizontal force.
HingeNumber	TypePropertyEnumeratedValue/PEnum_HingeNumber:Non,One,Two,Three	Indicates the hinge number of an arch bridge.
ArchCurveType	TypePropertyEnumeratedValue/PEnum_ArchCurveType:Arc,Parabola,Catenary	Indicates the axis type of an arch. It can be Arc, Parabola and Catenary.

#### 9.4.7 Pset\_RigidBridge

Name: Pset\_RigidBridge

Applicable Entities: IfcBridge\RIGIDFRAMEBRIDGE

Description: Common property set of rigid bridges.

Property Definitions: See Table 9.53.

**Table 9.53 Property definitions of Pset\_RigidBridge**

Name	Type	Description
StructureForm	TypePropertyEnumeratedValue/PEnum_StructureForm: Portal TypeRigidFrameBridge, SlantLeggedRigidFrameBridge, TRigidFrameBridge, ContinueRigidFrameBridge	Indicates the structure form of a rigid bridge. It can be Portal Type rigid frame bridge, slant legged rigid frame bridge, T-rigid frame bridge and continuous rigid frame bridge.

#### 9.4.8 Pset\_Gird

Name: Pset\_Gird

Applicable Entities: IfcBridgePart\GIRD

Description: Common property set of girds.

Property Definitions: See Table 9.54.

**Table 9.54 Property definitions of Pset\_Gird**

Name	Type	Description
StructureForm	TypePropertyEnumeratedValue/PEnum_StructureForm: BoxGird, T-Gird, SlabGird, TroughGird, CompositeGird.	Indicates the structure form of a gird. It can be BoxGird, T-Gird, SlabGird, TroughGird and CompositeGird.
StraightOrCurve	TypePropertyEnumeratedValue/PEnum_StraightOrCurve: Straight, Curve	Indicates the gird is straight or curve.
ConstantOrVariabl	TypePropertyEnumeratedValue/PEnum_	Indicates whether the size of the

eCrossSection	ConstantOrVariableCrossSection: ConstantSection, Variable Cross-Section	section of a gird is changed. It can be constant section or variable cross-section.
---------------	--	---

#### 9.4.9 Pset\_BridgePier

Name: Pset\_BridgePier

Applicable Entities: IfcBridgePart\PIER

Description: Common property set of bridge piers.

Property Definitions: See Table 9.55.

**Table 9.55 Property definitions of Pset\_Pier**

Name	Type	Description
StructureForm	TypePropertyEnumeratedValue/PEnum_StructureForm:SolidPier,HollowPier	Indicates the structure form of bridge pier. It can be solid pier or hollow pier.

#### 9.4.10 Pset\_PileCommon

Name: Pset\_PileCommon

Applicable Entities: IfcPile

Description: Common property set of pile foundation.

Property Definitions: See Table 9.56.

**Table 9.56 Property definitions of Pset\_PileCommon**

Name	Type	Description
PileArrangement	TypePropertyEnumeratedValue/PEnum_PileArrangement: Quincunx Determinant, Userdefined	Indicates the arrangement form of piles. It can be quincunx or determinant.
PileForceTransmit Type	TypePropertyEnumeratedValue/PEnum_PileForceTransmitType: ColumnPile, FrictionPile	Indicates the mode of bearing force of a pile. It can be column pile and friction pile.

#### 9.4.11 Pset\_Abutment

Name: Pset\_Abutment

Applicable Entities: IfcBridgePart\ABUTMENT

Description: Common property set of abutments.

Property Definitions: See Table 9.57.

**Table 9.57 Property definitions of Pset\_Abutment**

Name	Type	Description
StructureForm	TypePropertyEnumeratedValue/PEnum_StructureForm: One-glyph Type, T-Type	Indicates the structure form of an abutment. It can be One-glyph-Type or T-Type.

#### 9.4.12 Pset\_Culvert

Name: Pset\_Culvert

Applicable Entities: IfcBridgePart/ABUTMENT

Description: Common property set of culverts.

Property Definitions: See Table 9.58.

**Table 9.58 Property definitions of Pset\_Culvert**

Name	Type	Description
StructureForm	TypePropertyEnumeratedValue/PEnum_StructureForm:SlabCulvert,FrameCulvert,ArchCulvert,PipeCulvert	Indicates the structure form of a culvert. It can be slab culvert, frame culvert, arch culvert and pipe culvert.
PressureBearingType	TypePropertyEnumeratedValue/PEnum_PressureBearingType:HavePress, NonePress,HalfPress	Indicates the pressure bearing type of a culvert. It can be have press, none press and half press.
Function	TypePropertyEnumeratedValue/PEnum_Function:FloodDrainageCulvert,InterchangeCulvert,IrrigationCulvert,InvertedSiphonProtectionCulvert,IrrigationandInterchangeCulvert,FloodDrainageandInterchangeCulvert,FloodDrainageandIrrigationCulvert	Indicates the function of a culvert. It can be flood and drainage culvert interchange culvert, irrigation culvert, inverted siphon and protection culvert, irrigation and interchange culvert, flood drainage and interchange culvert, flood drainage and irrigation culvert.

#### 9.4.13 Pset\_BridgeBearing

Name: Pset\_BridgeBearing

Applicable Entities: IfcBridgeBearing

Description: Common property set of bridge bearings.

Property Definitions: See Table 9.59.

**Table 9.59 Property definitions of Pset\_BridgeBearing**

Name	Type	Description
DrawingNumber	TypePropertySingleValue/IfcLabel	Indicates the drawing number of the bridge bearing.
Type	TypePropertySingleValue/IfcLabel	Indicates the type of the bearing.
CarryingCapacity	TypePropertySingleValue/IfcForceMeasure/N	Indicates the carrying capacity of the bearing.
MoveOrientation	TypePropertyEnumeratedValue/PEnum_MoveOrientation: DX, ZX, HX, GD, Multi-Orientation.	The orientation of the bearing can be moved. It can be DX, ZX, HX, GD and Multi-Orientation.
SeismalAcceleration	TypePropertyEnumeratedValue/PEnum_SeismalAcceleration: $a \leq 0.1g$ , $0.1g < a \leq 0.2g$ , $0.2g < a \leq 0.3g$ , $0.3g < a \leq 0.4g$ , $a > 0.4g$	The rang of seismal acceleration of bearing can be used, it can be $a \leq 0.1g$ , $0.1g < a \leq 0.2g$ , $0.2g < a \leq 0.3g$ , $0.3g < a \leq 0.4g$ and $a > 0.4g$ .
Displacement	TypePropertySingleValue/IfcLengthMeasure/m	Indicates the displacement of the bearing.

#### 9.4.14 Pset\_BridgeExpansionInstallation



Name: Pset\_ExpansionInstallation

Applicable Entities: IfcBridgeExpansionInstallation

Description: Common property set of bridge expansion installation.

Property Definitions: See Table 9.60.

**Table 9.60 Property definitions of Pset\_BridgeExpansionInstallation**

<b>Name</b>	<b>Type</b>	<b>Description</b>
DrawingNumber	TypePropertySingleValue/IfcLabel	The drawing number of the bridge expansion installation.
Type	TypePropertySingleValue/IfcLabel	The type of the bridge expansion installation.
Displacement	TypePropertySingleValue/IfcLengthMeasure/m	The displacement of the expansion installation.
Length	TypePropertySingleValue/IfcLengthMeasure/m	The length of the expansion installation.

## **10. Tunnel Schema**

### **10.1 Schema Definition**

The information model defined in this schema is applicable to tunnel and its components designed and constructed with New Austrian Tunneling Method. The data structure of tunnel information model consists of IfcTunnelStructureElement, IfcTunnelElement and IfcElementComponent. The definition of element components refers to Section 4.3.

The spatial structure elements of tunnel mainly include IfcTunnel and IfcTunnelPart.

The physical elements of tunnel mainly consist of IfcTunnelAdvanceSupport, IfcTunnelPrimarySupport, IfcSystemAncherBolt, IfcSystemSteelFrame, IfcInitialSupportShotcrete, IfcTunnelLiningStructure, IfcTunnelPortalStructure, IfcTunnelInvertFilling, IfcWaterproofLayer, IfcLevelingBlanket, IfcProtectiveLayer, IfcTemporarySupport and IfcProtectiveArch.

The relationship between spatial structure elements and physical elements of tunnel is described in Figure 10.1.

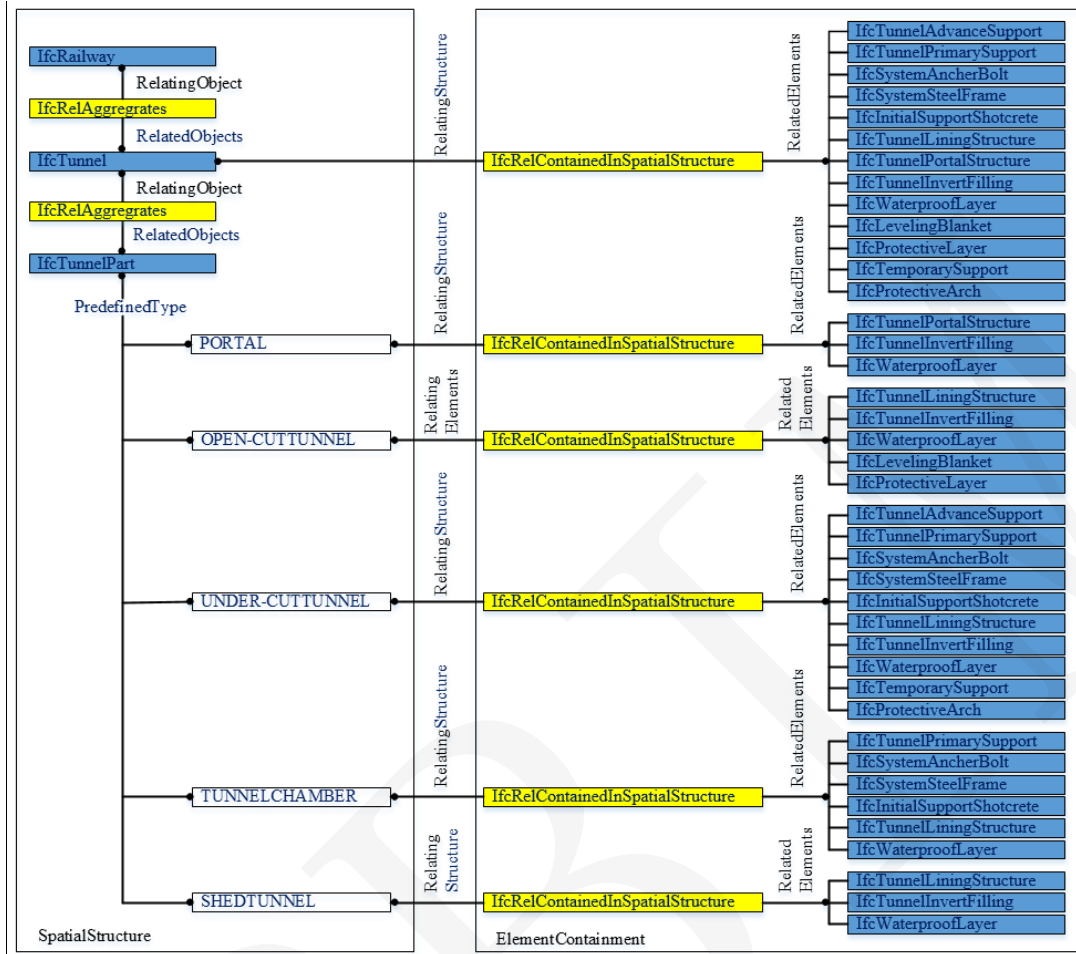

**Figure 10.1 Tunnel composition**

### 10.1.1 Spatial Structure Elements of Tunnel

As supertype of all the tunnel spatial structure elements, the `IfcTunnelStructureElement` inherits from `IfcCivilStructureElement`. And then `IfcTunnelStructureElement` derives `IfcTunnel` and `IfcTunnelPart`. The inheritance relationship is shown in Figure 10.2.

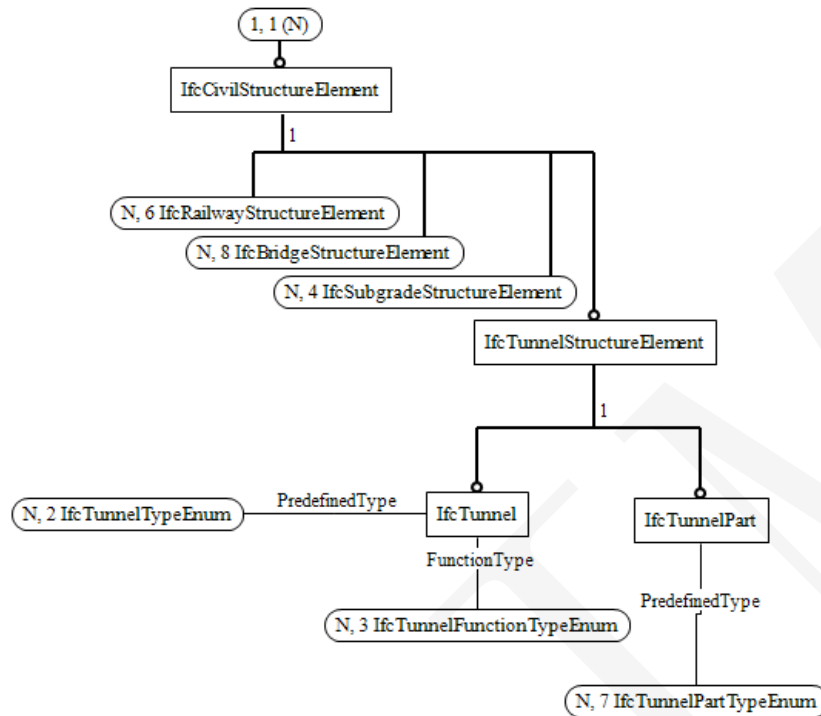

**Figure 10.2 EXPRESS-G diagram for the spatial structure elements of tunnel**

IfcTunnelStructureElement inherits from IfcCivilStructureElement and is the supertype of all the spatial structure elements of tunnel.

IfcTunnel refers to a tunnel which is spatially composed of a number of IfcTunnelParts. IfcTunnel is further subdivided into CIRCULARTUNNEL, CURVEDWALLANDARCHCROWNTUNNEL, STRAIGHTWALLANDARCHCROWNTUNNEL, RECTANGULARTUNNEL, THESHEDTUNNEL and THEOPEN-CUTTUNNEL by PredefinedType property. IfcTunnel can be subdivided into RAILWAYTUNNEL, HIGHWAYTUNNEL, HYDRAULICTUNNEL, MUNICIPALTUNNEL, MINETUNNEL and SERVICEGALLERY by FunctionType property.

IfcTunnelPart refers to the various parts forming a tunnel. IfcTunnelPart can be further divided into PORTAL, OPEN-CUTTUNNEL, UNDER-CUTTUNNEL, TUNNELCHAMBER and SHEDTUNNEL by PredefinedType property.

### 10.1.2 Physical Elements of Tunnel

The EXPRESS-G diagram for physical elements of tunnel is shown in Figure 10.3.

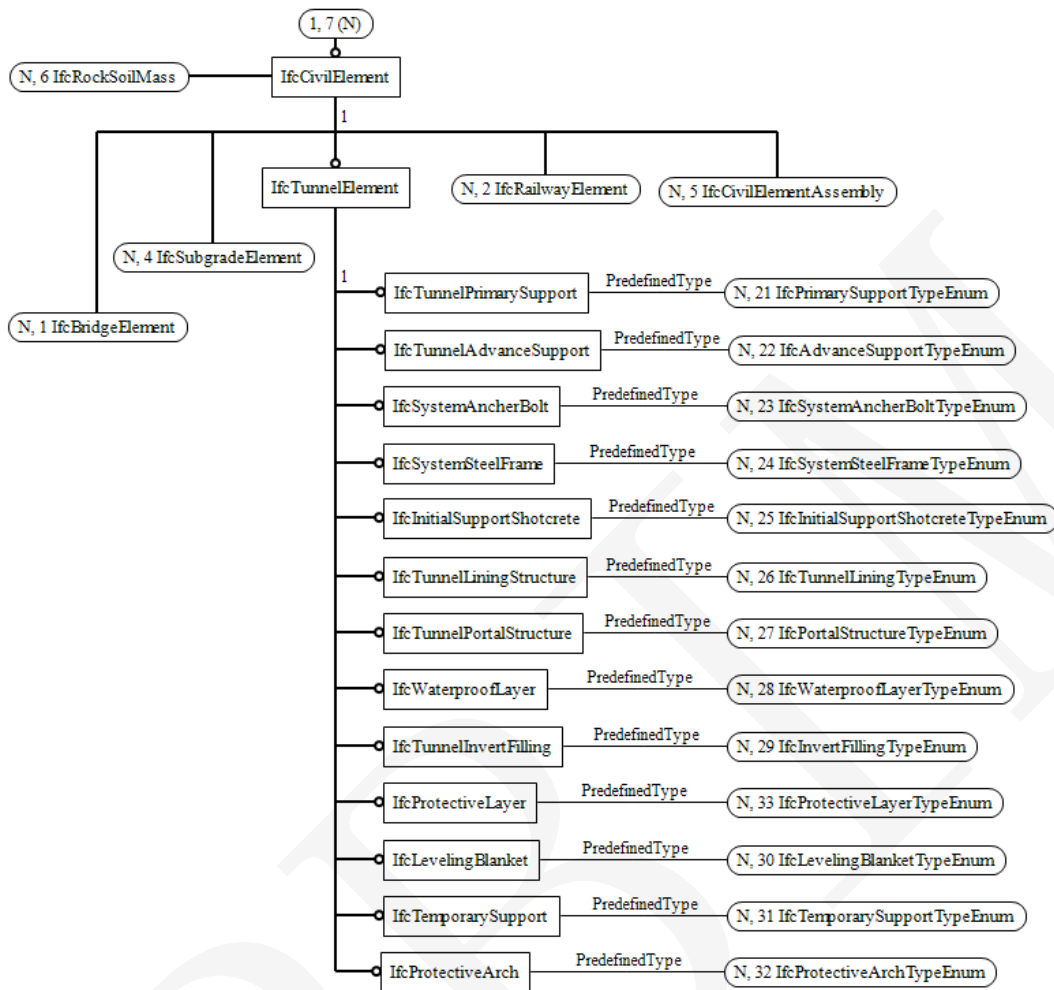

**Figure 10.3 EXPRESS-G diagram for physical elements of tunnel**

IfcTunnelElement inherits from IfcCivilElement and is the supertype of all the tunnel elements.

IfcTunnelAdvanceSupport refers to a pre-reinforced support to the face of surrounding rock before tunnel excavation. It inherits from IfcTunnelElement and is contained in UNDER-CUT TUNNEL or TUNNELCHAMBER. IfcTunnelAdvanceSupport is further subdivided into ADVANCEPIPE-ROOFSUPPORT, ADVANCEFOREPOLING and GROUTING by predefined types.

IfcTunnelPrimarySupport refers to the supporting structure made immediately after the excavation. It inherits from IfcTunnelElement and is contained in UNDER-CUTTUNNEL or TUNNELCHAMBER.

IfcSystemAncherBolt refers to the anchor group arranged according to certain vertical and horizontal spacing along the tunnel perimeter to stabilize the surrounding rock. It inherits from IfcTunnelElement and is contained in under-cut tunnel or tunnel chamber.

IfcSystemSteelFrame refers to the frame supporting structure made of section steels, steel rails or steel bars. It inherits from IfcTunnelElement and is contained in UNDER-CUTTUNNEL or TUNNELCHAMBER.

IfcInitialSupportShotcrete refers to a kind of concrete structure. The concrete mixture is vertically sprayed on the surface at a higher speed utilizing the compressed air or other power to be compacted by the continuous impact of cement and aggregate during the spraying process. It inherits from IfcTunnelElement and is contained in UNDER-CUTTUNNEL or TUNNELCHAMBER.

IfcTunnelLiningStructure refers to the permanent supporting structure of tunnel. It inherits from IfcTunnelElement and is contained in under-cut tunnel, open-cut tunnel or tunnel chamber. IfcTunnelLiningStructure is further subdivided into ARCHWALLLINING, INVERTLINING, SEGMENT and BASESLAB by predefined types.

IfcTunnelPortalStructure refers to door type building to maintain the stability of the front slope and side slope, to guide drainage slope flow and to decorate the entrance. It inherits from IfcTunnelElement and is contained in the spatial structure element of tunnel portal. IfcTunnelPortalStructure is further subdivided into HATSTYLEPORTALSTRUCTURE, BELLSTYLEPORTALSTRUCTURE, STRAIGHT-CUTPORTALSTRUCTURE, POURCHAMFEREDPORTALSTRUCTURE, BUFFEREDPORTALSTRUCTURE and ENDWALLPORTALSTRUCTURE by predefined types.

IfcTunnelInvertFilling refers to the concrete filled in the tunnel invert. It inherits from IfcTunnelElement and is contained in PORTAL, OPEN-CUTTUNNEL or UNDER-CUTTUNNEL.

IfcWaterproofLayer refers to the waterproof structure attached to the lining, construction joints and deformation joints. It inherits from IfcTunnelElement and is contained in PORTAL, OPEN-CUTTUNNEL or UNDER-CUTTUNNEL.

IfcLevelingBlanket refers to the cushion at the bottom of the structure or the leveling layer before the waterproof layer. It inherits from IfcTunnelElement and is contained in PORTAL or OPEN-CUTTUNNEL.

IfcProtectiveLayer refers to the protective layer for the tunnel portal or open-cut tunnel before backfilling. It inherits from IfcTunnelElement and is contained in PORTAL or OPEN-CUTTUNNEL.

IfcTemporarySupport refers to the temporary support to maintain the stability of the surrounding rock during the process of tunnel excavation. The support needs to be removed in the construction process. It inherits from IfcTunnelElement and is contained in UNDER-CUTTUNNEL.

IfcProtectiveArch refers to the protective structure to ensure the safety of tunnel excavation which is usually chosen when there is no condition for open cutting. It inherits from IfcTunnelElement and is contained in UNDER-CUTTUNNEL.

## **10.2 Type Definition**

### **10.2.1 IfcTunnelTypeEnum**

This enumeration defines the different predefined types of tunnels that can further specify an

IfcTunnel.

**Enumerated Item Definitions:**

CIRCULARTUNNEL;  
CURVEDWALLANDARCHCROWNTUNNEL;  
STRAIGHTWALLANDARCHCROWNTUNNEL;  
RECTANGULARTUNNEL;  
THESHEDTUNNEL;  
THEOPEN-CUTTUNNEL;  
USERDEFINED;  
NOTDEFINED.

**EXPRESS Specification:**

TYPE IfcTunnelTypeEnum = ENUMERATION OF

(CIRCULARTUNNEL,  
CURVEDWALLANDARCHCROWNTUNNEL,  
STRAIGHTWALLANDARCHCROWNTUNNEL,  
RECTANGULARTUNNEL,  
THESHEDTUNNEL,  
THEOPEN-CUTTUNNEL,  
USERDEFINED,  
NOTDEFINED);

END\_TYPE;

**10.2.2 IfcTunnelFunctionTypeEnum**

This enumeration defines the different function types of tunnels.

**Enumerated Item Definitions:**

RAILWAYTUNNEL;  
HIGHWAYTUNNEL;  
HYDRAULICTUNNEL;  
MUNICIPALTUNNEL;  
MINETUNNEL;  
SERVICEGALLERY;  
USERDEFINED;  
NOTDEFINED.

**EXPRESS Specification:**

TYPE IfcTunnelFunctionTypeEnum = ENUMERATION OF

(RAILWAYTUNNEL,  
HIGHWAYTUNNEL,

```
HYDRAULICTUNNEL,  
MUNICIPALTUNNEL,  
MINETUNNEL,  
SERVICEGALLERY,  
USERDEFINED,  
NOTDEFINED);  
END_TYPE;
```

### 10.2.3 IfcTunnelPartTypeEnum

This enumeration defines the different composition types of tunnels.

#### Enumerated Item Definitions:

```
PORTAL;  
OPEN-CUTTUNNEL;  
UNDER-CUTTUNNEL;  
TUNNELCHAMBER;  
SHEDTUNNEL;  
USERDEFINED;  
NOTDEFINED.
```

#### EXPRESS Specification:

```
TYPE IfcTunnelPartTypeEnum = ENUMERATION OF  
  (PORTAL,  
  OPEN-CUTTUNNEL,  
  UNDER-CUTTUNNEL,  
  TUNNELCHAMBER,  
  SHEDTUNNEL,  
  USERDEFINED,  
  NOTDEFINED);  
END_TYPE;
```

### 10.2.4 IfcAdvanceSupportTypeEnum

This enumeration defines the different advance support types of tunnels.

#### Enumerated Item Definitions:

```
ADVANCEPIPE-ROOFSUPPORT;  
ADVANCEFOREPOLING;  
GROUTING;  
USERDEFINED;  
NOTDEFINED.
```

#### EXPRESS Specification:

```
TYPE IfcAdvanceSupportTypeEnum = ENUMERATION OF  
  (ADVANCEPIPE-ROOFSUPPORT,
```

ADVANCEFOREPOLING,  
GROUTING,  
USERDEFINED,  
NOTDEFINED);  
END\_TYPE;

#### **10.2.5 IfcPrimarySupportTypeEnum**

This enumeration defines the different primary support types of tunnels.

##### **Enumerated Item Definitions:**

USERDEFINED;  
NOTDEFINED.

##### **EXPRESS Specification:**

TYPE IfcPrimarySupportTypeEnum = ENUMERATION OF  
(USERDEFINED,  
NOTDEFINED);  
END\_TYPE;

#### **10.2.6 IfcSystemAncherBoltTypeEnum**

This enumeration defines the different ancher bolt types of tunnels.

##### **Enumerated Item Definitions:**

USERDEFINED;  
NOTDEFINED.

##### **EXPRESS Specification:**

TYPE IfcSystemAncherBoltTypeEnum = ENUMERATION OF  
(USERDEFINED,  
NOTDEFINED);  
END\_TYPE;

#### **10.2.7 IfcSystemSteelFrameTypeEnum**

This enumeration defines the different system steel frame types of tunnels.

##### **Enumerated Item Definitions:**

USERDEFINED;  
NOTDEFINED.

##### **EXPRESS Specification:**

TYPE IfcSystemSteelFrameTypeEnum = ENUMERATION OF  
(USERDEFINED,  
NOTDEFINED);  
END\_TYPE;

#### **10.2.8 IfcInitialSupportShotcreteTypeEnum**



This enumeration defines the different initial support shotcrete types of tunnels.

**Enumerated Item Definitions:**

USERDEFINED;  
NOTDEFINED.

**EXPRESS Specification:**

```
TYPE IfcInitialSupportShotcreteTypeEnum = ENUMERATION OF  
  (USERDEFINED,  
   NOTDEFINED);  
END_TYPE;
```

**10.2.9 IfcTunnelLiningTypeEnum**

This enumeration defines the different lining types of tunnels.

**Enumerated Item Definitions:**

ARCHWALLLINING;  
INVERTLINING;  
SEGMENT;  
BASESLAB;  
USERDEFINED;  
NOTDEFINED.

**EXPRESS Specification:**

```
TYPE IfcTunnelLiningTypeEnum = ENUMERATION OF  
  (ARCHWALLLINING,  
   INVERTLINING,  
   SEGMENT,  
   BASESLAB,  
   USERDEFINED,  
   NOTDEFINED);  
END_TYPE;
```

**10.2.10 IfcPortalStructureTypeEnum**

This enumeration defines the different portal structure types of tunnels.

**Enumerated Item Definitions:**

HATSTYLEPORTALSTRUCTURE;  
BELLSTYLEPORTALSTRUCTURE;  
STRAIGHT-CUTPORTALSTRUCTURE;  
POURCHAMFEREDPORTALSTRUCTURE;  
BUFFEREDPORTALSTRUCTURE;  
ENDWALLPORTALSTRUCTURE;

USERDEFINED;  
NOTDEFINED.

**EXPRESS Specification:**

TYPE IfcPortalStructureTypeEnum = ENUMERATION OF  
(HATSTYLEPORTALSTRUCTURE,  
BELLSTYLEPORTALSTRUCTURE,  
STRAIGHT-CUTPORTALSTRUCTURE,  
POURCHAMFEREDPORTALSTRUCTURE,  
BUFFEREDPORTALSTRUCTURE,  
ENDWALLPORTALSTRUCTURE,  
USERDEFINED,  
NOTDEFINED);  
END\_TYPE;

**10.2.11 IfcInvertFillingTypeEnum**

This enumeration defines the different invert filling types of tunnels.

**Enumerated Item Definitions:**

USERDEFINED;  
NOTDEFINED.

**EXPRESS Specification:**

TYPE IfcInvertFillingTypeEnum = ENUMERATION OF  
(USERDEFINED,  
NOTDEFINED);  
END\_TYPE;

**10.2.12 IfcWaterproofLayerTypeEnum**

This enumeration defines the different waterproof layer types of tunnels.

**Enumerated Item Definitions:**

USERDEFINED;  
NOTDEFINED.

**EXPRESS Specification:**

TYPE IfcWaterproofLayerTypeEnum = ENUMERATION OF  
(USERDEFINED,  
NOTDEFINED);  
END\_TYPE;

**10.2.13 IfcLevelingBlanketTypeEnum**

This enumeration defines the different leveling blanket types of tunnels.

**Enumerated Item Definitions:**

USERDEFINED;

NOTDEFINED.

**EXPRESS Specification:**

```
TYPE IfcLevelingBlanketTypeEnum = ENUMERATION OF
  (USERDEFINED,
   NOTDEFINED);
END_TYPE;
```

**10.2.14 IfcProtectiveLayerTypeEnum**

This enumeration defines the different protective layer types of tunnels.

**Enumerated Item Definitions:**

USERDEFINED;  
NOTDEFINED.

**EXPRESS Specification:**

```
TYPE IfcProtectiveLayerTypeEnum = ENUMERATION OF
  (USERDEFINED,
   NOTDEFINED);
END_TYPE;
```

**10.2.15 IfcProtectiveArchTypeEnum**

This enumeration defines the different protective arch types of tunnels.

**Enumerated Item Definitions:**

USERDEFINED;  
NOTDEFINED.

**EXPRESS Specification:**

```
TYPE IfcProtectiveArchTypeEnum = ENUMERATION OF
  (USERDEFINED,
   NOTDEFINED);
END_TYPE;
```

**10.2.16 IfcTemporarySupportTypeEnum**

This enumeration defines the different Temporary Support types of tunnels.

**Enumerated Item Definitions:**

USERDEFINED;  
NOTDEFINED.

**EXPRESS Specification:**

```
TYPE IfcTemporarySupportTypeEnum = ENUMERATION OF
  (USERDEFINED,
   NOTDEFINED);
```

END\_TYPE;

### 10.3 Entity Definition

#### 10.3.1 IfcTunnelStructureElement

IfcTunnelStructureElement is the supertype of all the spatial structure elements of tunnel.

**EXPRESS Specification:**

```
ENTITY IfcTunnelStructureElement
  SUPERTYPE OF (ONEOF (IfcTunnel, IfcTunnelPart))
  SUBTYPE OF (IfcCivilStructureElement);
END_ENTITY;
```

#### 10.3.2 IfcTunnel

IfcTunnel refers to a tunnel which is a part of IfcRailway and is composed of a number of IfcTunnelPart in space. IfcTunnel is further subdivided into CIRCULARTUNNEL, CURVEDWALLANDARCHCROWNTUNNEL, STRAIGHTWALLANDARCHCROWNTUNNEL, RECTANGULARTUNNEL, THESHEDTUNNEL, THEOPEN-CUTTUNNEL by predefined types and into RAILWAYTUNNEL, HIGHWAYTUNNEL, HYDRAULICTUNNEL, MUNICIPALTUNNEL, MINETUNNEL, SERVICEGALLERY by function types.

**Table 10.1 IfcTunnel spatial composition**

Spatial Composite	Description
IfcRailway	IfcTunnel is a part of IfcRailway.

**Table 10.2 IfcTunnel spatial decomposition**

Spatial Parts	Description
IfcTunnelPart	IfcTunnel is composed of one or more IfcTunnelPart.

**Table 10.3 Property sets for IfcTunnel**

PredefinedType	Name
	Pset_TunnelCommon

**EXPRESS Specification:**

```
ENTITY IfcTunnel
  SUBTYPE OF (IfcTunnelStructureElement);
  PredefinedType: IfcTunnelTypeEnum;
  FunctionType: IfcTunnelFunctionTypeEnum;
END_ENTITY;
```

**Attribute definitions:**

PredefinedType: IfcTunnel is further subdivided into CIRCULARTUNNEL, CURVEDWALLANDARCHCROWNTUNNEL, STRAIGHTWALLANDARCHCROWNTUNNEL, RECTANGULARTUNNEL, THESHEDTUNNEL and THEOPEN-CUTTUNNEL by structural style.

FunctionType: IfcTunnel is further subdivided into RAILWAYTUNNEL, HIGHWAYTUNNEL, HYDRAULICTUNNEL, MUNICIPALTUNNEL, MINETUNNEL and SERVICEGALLERY by function.

### 10.3.3 IfcTunnelPart

IfcTunnelPart is the decomposition of an IfcTunnel in terms of spatial structure, containing various tunnel elements. IfcTunnel is further subdivided into PORTAL, OPEN-CUTTUNNEL, UNDER-CUTTUNNEL, TUNNELCHAMBER and SHEDTUNNEL by predefined types.

**Table 10.4 IfcTunnelPart spatial composition**

Spatial Composite	Description
IfcTunnel	IfcTunnelPart is a part of IfcTunnel.

**Table 10.5 IfcTunnelPart spatial containment**

PredefinedType	Contained Entities	Description
PORTAL	IfcTunnelPortalStructure,IfcTunnelInvertFilling,IfcWaterproofLayer	Portal can contain IfcTunnelPortalStructure, IfcTunnelInvertFilling and IfcWaterproofLayer.
OPEN-CUTTUNNEL	IfcTunnelLiningStructure,IfcTunnelInvertFilling,IfcWaterproofLayer,IfcLevelingBlanket,IfcProtectiveLayer	Open-cut tunnel can contain IfcTunnelLiningStructure, IfcTunnelInvertFilling, IfcWaterproofLayer, IfcLevelingBlanket and IfcProtectiveLayer.
UNDER-CUTTUNNEL	IfcTunnelAdvanceSupport,IfcTunnelPrimarySupport,IfcSystemAncherBolt,IfcSystemSteelFrame,IfcInitialSupportShotcrete,IfcTunnelLiningStructure,IfcTunnelInvertFilling,IfcWaterproofLayer,IfcTemporarySupport,IfcProtectiveArch	Under-cut tunnel can contain IfcTunnelAdvanceSupport, IfcTunnelPrimarySupport, IfcSystemAncherBolt, IfcSystemSteelFrame, IfcInitialSupportShotcrete, IfcTunnelLiningStructure, IfcTunnelInvertFilling, IfcWaterproofLayer, IfcTemporarySupport and IfcProtectiveArch.
TUNNELCHAMBER	IfcTunnelPrimarySupport,IfcSystemAncherBolt,IfcSystemSteel	Tunnel chamber can contain IfcTunnelPrimarySupport,

	IfcFrame,IfcInitialSupportShotcrete,IfcTunnelLiningStructure,IfcWaterproofLayer	IfcSystemAncherBolt, IfcSystemSteelFrame, IfcInitialSupportShotcrete, IfcTunnelLiningStructure and IfcWaterproofLayer.
SHEDTUNNEL	IfcTunnelLiningStructure,IfcTunnelInvertFilling,IfcWaterproofLayer	Shed tunnel can contain IfcTunnelLiningStructure, IfcTunnelInvertFilling and IfcWaterproofLayer.

**Table 10.6 Property sets for IfcTunnelPart**

PredefinedType	Name
PORTAL	Pset_PortalCommon
OPEN-CUTTUNNEL	Pset_Open-cutTunnelCommon
UNDER-CUTTUNNEL	Pset_Under-cutTunnelCommon
TUNNELCHAMBER	Pset_TunnelChamberCommon
SHEDTUNNEL	Pset_ShedTunnelCommon

**EXPRESS Specification:**

ENTITY IfcTunnelPart  
SUBTYPE OF (IfcTunnelStructureElement);  
PreDefinedType: IfcTunnelPartTypeEnum;  
END\_ENTITY;

**Attribute definitions:**

PreDefinedType: IfcTunnelPart is further subdivided into PORTAL, OPEN-CUTTUNNEL, UNDER-CUTTUNNEL, TUNNELCHAMBER and SHEDTUNNEL by structural style.

**10.3.4 IfcTunnelElement**

IfcTunnelElement is the supertype of all tunnel physical elements.

**EXPRESS Specification:**

ENTITY IfcTunnelElement  
SUPERTYPE OF (ONEOF  
(IfcTunnelAdvanceSupport,  
IfcTunnelPrimarySupport,  
IfcSystemAncherBolt,  
IfcSystemSteelFrame,  
IfcInitialSupportShotcrete,  
IfcTunnelLiningStructure,  
IfcTunnelPortalStructure,  
IfcTunnelInvertFilling,  
IfcWaterproofLayer,

IfcLevelingBlanket,  
 IfcProtectiveLayer,  
 IfcTemporarySupport,  
 IfcProtectiveArch))  
 SUBTYPE OF (IfcCivilElement);  
 END\_ENTITY;

### 10.3.5 IfcTunnelAdvanceSupport

IfcTunnelAdvanceSupport refers to a pre-reinforced support to the face of surrounding rock before tunnel excavation. It inherits from IfcTunnelElement and is contained in UNDER-CUTTUNNEL or TUNNELCHAMBER. IfcTunnelAdvanceSupport is further subdivided into ADVANCEPIPE-ROOFSUPPORT, ADVANCEFOREPOLING and GROUTING by predefined types.

**Table 10.7 Property sets for IfcTunnelAdvanceSupport**

PredefinedType	Name
	Pset_TunnelAdvanceSupportCommon

**Table 10.8 IfcTunnelAdvanceSupport contained in spatial structure**

Spatial Structure	Description
IfcTunnelPart/UNDER-CUTTUNNEL	IfcTunnelAdvanceSupport should be contained in UNDER-CUTTUNNEL.
IfcTunnelPart/TUNNELCHAMBER	IfcTunnelAdvanceSupport is also contained in TUNNELCHAMBER.

**EXPRESS Specification:**

ENTITY IfcTunnelAdvanceSupport  
 SUBTYPE OF (IfcTunnelElement);  
 PreDefinedType: IfcTunnelAdvanceSupportTypeEnum;  
 END\_ENTITY;

**Attribute definitions:**

PreDefinedType: IfcTunnelAdvanceSupport is further subdivided into ADVANCEPIPE-ROOFSUPPORT, ADVANCEFOREPOLING and GROUTING by structural style.

### 10.3.6 IfcTunnelPrimarySupport

IfcTunnelPrimarySupport refers to the supporting structure made immediately after the excavation. It inherits from IfcTunnelElement and is contained in UNDER-CUTTUNNEL or TUNNELCHAMBER which are the predefined types of IfcTunnelPart.

**Table 10.9 Property sets for IfcTunnelPrimarySupport**

PredefinedType	Name
	Pset_TunnelPrimarySupportCommon

**Table 10.10 IfcTunnelPrimarySupport contained in spatial structure**

Spatial Structure	Description
IfcTunnelPart/UNDER-CUTTUNNEL	IfcTunnelPrimarySupport should be contained in UNDER-CUTTUNNEL.
IfcTunnelPart/TUNNELCHAMBER	IfcTunnelPrimarySupport is also contained in TUNNELCHAMBER.

**EXPRESS Specification:**

ENTITY IfcTunnelPrimarySupport  
SUBTYPE OF (IfcTunnelElement);  
PreDefinedType: IfcTunnelPrimarySupportTypeEnum;  
END\_ENTITY;

**Attribute definitions:**

PreDefinedType.

**10.3.7 IfcSystemAnchorBolt**

IfcSystemAnchorBolt refers to the anchor group arranged according to certain vertical and horizontal spacing along the tunnel perimeter to stabilize the surrounding rock. It inherits from IfcTunnelElement and is contained in UNDER-CUTTUNNEL or TUNNELCHAMBER.

**Table 10.11 Property sets for IfcSystemAnchorBolt**

PredefinedType	Name
	Pset_SystemAnchorBoltCommon

**Table 10.12 IfcSystemAnchorBolt contained in spatial structure**

Spatial Structure	Description
IfcTunnelPart/UNDER-CUTTUNNEL	IfcSystemAnchorBolt should be contained in UNDER-CUTTUNNEL.
IfcTunnelPart/TUNNELCHAMBER	IfcSystemAnchorBolt is also contained in TUNNELCHAMBER.

**EXPRESS Specification:**

ENTITY IfcSystemAnchorBolt  
SUBTYPE OF (IfcTunnelElement);  
PreDefinedType: IfcSystemAnchorBoltTypeEnum;  
END\_ENTITY;

**Attribute definitions:**

PreDefinedType.

**10.3.8 IfcSystemSteelFrame**

IfcSystemSteelFrame refers to the frame supporting structure made of section steels, steel rails or steel bars. It inherits from IfcTunnelElement and is contained in UNDER-CUTTUNNEL or TUNNELCHAMBER.

**Table 10.13 Property sets for IfcSystemSteelFrame**



PredefinedType	Name
	Pset_SystemSteelFrameCommon

**Table 10.14 IfcSystemSteelFrame contained in spatial structure**

Spatial Structure	Description
IfcTunnelPart/UNDER-CUTTUNNEL	IfcSystemSteelFrame should be contained in UNDER-CUTTUNNEL.
IfcTunnelPart/TUNNELCHAMBER	IfcSystemSteelFrame is also contained in TUNNELCHAMBER.

**EXPRESS Specification:**

ENTITY IfcSystemSteelFrame  
SUBTYPE OF (IfcTunnelElement);  
PreDefinedType: IfcSystemSteelFrameTypeEnum;  
END\_ENTITY;

**Attribute definitions:**

PreDefinedType.

**10.3.9 IfcInitialSupportShotcrete**

IfcInitialSupportShotcrete refers to a kind of concrete structure. The concrete mixture is vertically sprayed on the surface at a higher speed utilizing the compressed air or other power to be compacted by the continuous impact of cement and aggregate during the spraying process. It inherits from IfcTunnelElement and is contained in UNDER-CUTTUNNEL or TUNNELCHAMBER.

**Table 10.15 Property sets for IfcInitialSupportShotcrete**

PredefinedType	Name
	Pset_InitialSupportShotcreteCommon

**Table 10.16 IfcInitialSupportShotcrete contained in spatial structure**

Spatial Structure	Description
IfcTunnelPart/UNDER-CUTTUNNEL	IfcInitialSupportShotcrete should be contained in UNDER-CUTTUNNEL.
IfcTunnelPart/TUNNELCHAMBER	IfcInitialSupportShotcrete is also contained in TUNNELCHAMBER.

**EXPRESS Specification:**

ENTITY IfcInitialSupportShotcrete  
SUBTYPE OF (IfcTunnelElement);  
PreDefinedType: IfcInitialSupportShotcreteTypeEnum;  
END\_ENTITY;

**Attribute definitions:**

PreDefinedType.

**10.3.10 IfcTunnelLiningStructure**

IfcTunnelLiningStructure refers to the permanent supporting structure of tunnel. It inherits from IfcTunnelElement and is contained in UNDER-CUTTUNNEL, OPEN-CUTTUNNEL or TUNNELCHAMBER. IfcTunnelLiningStructure is further subdivided into ARCHWALLLINING, INVERTLINING, SEGMENT and BASESLAB by PredefinedType property.

**Table 10.17 Property sets for IfcTunnelLiningStructure**

PredefinedType	Name
	Pset_TunnelLiningStructureCommon

**Table 10.18 IfcTunnelLiningStructure contained in spatial structure**

Spatial Structure	Description
IfcTunnelPart/UNDER-CUTTUNNEL	IfcTunnelLiningStructure should be contained in UNDER-CUTTUNNEL.
IfcTunnelPart/OPEN-CUTTUNNEL	IfcTunnelLiningStructure is also contained in OPEN-CUTTUNNEL.
IfcTunnelPart/TUNNELCHAMBER	IfcTunnelLiningStructure is also contained in TUNNELCHAMBER.

**EXPRESS Specification:**

```
ENTITY IfcTunnelLiningStructure
  SUBTYPE OF (IfcTunnelElement);
  PreDefinedType: IfcTunnelLiningStructureTypeEnum;
END_ENTITY;
```

**Attribute definitions:**

PreDefinedType: IfcTunnelLiningStructure is further subdivided into ARCHWALLLINING, INVERTLINING, SEGMENT and BASESLAB by structural style.

**10.3.11 IfcTunnelPortalStructure**

IfcTunnelPortalStructure refers to door type building to maintain the stability of the front slope and side slope, to guide drainage slope flow and to decorate the entrance. It inherits from IfcTunnelElement and is contained in the spatial structure element of tunnel portal. IfcTunnelPortalStructure is further subdivided into HATSTYLEPORTALSTRUCTURE, BELLSTYLEPORTALSTRUCTURE, STRAIGHT-CUTPORTALSTRUCTURE, POURCHAMFEREDPORTALSTRUCTURE, BUFFEREDPORTALSTRUCTURE, and ENDWALLPORTALSTRUCTURE by predefined types.

**Table 10.19 IfcTunnelPortalStructure contained in spatial structure**

Spatial Structure	Description
IfcTunnelPart/PORTAL	IfcTunnelPortalStructure should be contained in PORTAL.

**EXPRESS Specification:**

```
ENTITY IfcTunnelPortalStructure
```

SUBTYPE OF (IfcTunnelElement);  
 PreDefinedType: IfcTunnelPortalStructureTypeEnum;  
 END\_ENTITY;

**Attribute definitions:**

PreDefinedType: IfcTunnelPortalStructure is further subdivided into HATSTYLEPORTALSTRUCTURE, BELLSTYLEPORTALSTRUCTURE, STRAIGHT-CUTPORTALSTRUCTURE, POURCHAMFEREDPORTALSTRUCTURE, BUFFEREDPORTALSTRUCTURE and ENDWALLPORTALSTRUCTURE by structural style.

**10.3.12 IfcTunnelInvertFilling**

IfcTunnelInvertFilling refers to the concrete filled in the tunnel invert. It inherits from IfcTunnelElement and is contained in PORTAL, OPEN-CUTTUNNEL or UNDER-CUTTUNNEL.

**Table 10.20 IfcTunnelInvertFilling contained in spatial structure**

Spatial Structure	Description
IfcTunnelPart/PORTAL	IfcTunnelInvertFilling should be contained in PORTAL.
IfcTunnelPart/OPEN-CUTTUNNEL	IfcTunnelInvertFilling is also contained in OPEN-CUTTUNNEL.
IfcTunnelPart/UNDER-CUTTUNNEL	IfcTunnelInvertFilling is also contained in UNDER-CUTTUNNEL.

**EXPRESS Specification:**

ENTITY IfcTunnelInvertFilling  
 SUBTYPE OF (IfcTunnelElement);  
 PreDefinedType: IfcTunnelInvertFillingTypeEnum;  
 END\_ENTITY;

**Attribute definitions:**

PreDefinedType.

**10.3.13 IfcWaterproofLayer**

IfcWaterproofLayer refers to the waterproof structure attached to the lining, construction joints and deformation joints. It inherits from IfcTunnelElement and is contained in PORTAL, OPEN-CUTTUNNEL or UNDER-CUTTUNNEL.

**Table 10.21 Property sets for IfcWaterproofLayer**

PredefinedType	Name
	Pset_WaterproofLayer

**Table 10.22 IfcWaterproofLayer contained in spatial structure**

Spatial Structure	Description
IfcTunnelPart/PORTAL	IfcWaterproofLayer should be contained in PORTAL.

IfcTunnelPart/OPEN-CUTTUNNEL	IfcWaterproofLayer is also contained in OPEN-CUTTUNNEL.
IfcTunnelPart/UNDER-CUTTUNNEL	IfcWaterproofLayer is also contained in UNDER-CUTTUNNEL.

**EXPRESS Specification:**

ENTITY IfcWaterproofLayer  
 SUBTYPE OF (IfcTunnelElement);  
 PreDefinedType: IfcWaterproofLayerTypeEnum;  
 END\_ENTITY;

**Attribute definitions:**

PreDefinedType.

**10.3.14 IfcLevelingBlanket**

IfcLevelingBlanket refers to the cushion at the bottom of the structure or the leveling layer before the waterproof layer. It inherits from IfcTunnelElement and is contained in PORTAL or OPEN-CUTTUNNEL.

**Table 10.23 Property sets for IfcLevelingBlanket**

PredefinedType	Name
	Pset_LevelingBlanketCommon

**Table 10.24 IfcLevelingBlanket contained in spatial structure**

Spatial Structure	Description
IfcTunnelPart/PORTAL	IfcLevelingBlanket should be contained in PORTAL.
IfcTunnelPart/OPEN-CUTTUNNEL	IfcLevelingBlanket is also contained in OPEN-CUTTUNNEL.

**EXPRESS Specification:**

ENTITY IfcLevelingBlanket  
 SUBTYPE OF (IfcTunnelElement);  
 PreDefinedType: IfcLevelingBlanketTypeEnum;  
 END\_ENTITY;

**Attribute definitions:**

PreDefinedType.

**10.3.15 IfcProtectiveLayer**

IfcProtectiveLayer refers to the protective layer for the tunnel portal or open-cut tunnel before backfilling. It inherits from IfcTunnelElement and is contained in PORTAL or OPEN-CUTTUNNEL.

**Table 10.25 Property sets for IfcProtectiveLayer**

PredefinedType	Name
	Pset_IfcProtectiveLayerCommon

**Table 10.26 IfcLevelingBlanket contained in spatial structure**

<b>Spatial Structure</b>	<b>Description</b>
IfcTunnelPart/PORTAL	IfcProtectiveLayer should be contained in PORTAL.
IfcTunnelPart/OPEN-CUTTUNNEL	IfcProtectiveLayer is also contained in OPEN-CUTTUNNEL.

**EXPRESS Specification:**

ENTITY IfcProtectiveLayer  
 SUBTYPE OF (IfcTunnelElement);  
 PreDefinedType: IfcProtectiveLayerTypeEnum;  
 END\_ENTITY;

**Attribute definitions:**

PreDefinedType.

**10.3.16 IfcTemporarySupport**

IfcTemporarySupport refers to the temporary support to maintain the stability of the surrounding rock during the process of tunnel excavation. The support needs to be removed in the construction process. It inherits from IfcTunnelElement and is contained in UNDER-CUTTUNNEL.

**Table 10.27 IfcTemporarySupport contained in spatial structure**

<b>Spatial Structure</b>	<b>Description</b>
IfcTunnelPart/UNDER-CUTTUNNEL	IfcTemporarySupport should be contained in UNDER-CUTTUNNEL.

**EXPRESS Specification:**

ENTITY IfcTemporarySupport  
 SUBTYPE OF (IfcTunnelElement);  
 PreDefinedType: IfcTemporarySupportTypeEnum;  
 END\_ENTITY;

**Attribute definitions:**

PreDefinedType.

**10.3.17 IfcProtectiveArch**

IfcProtectiveArch refers to the protective structure to ensure the safety of tunnel excavation which is usually chosen when there is no condition for open cutting. It inherits from IfcTunnelElement and is contained in UNDER-CUTTUNNEL.

**Table 10.28 IfcProtectiveArch contained in spatial structure**

<b>Spatial Structure</b>	<b>Description</b>
IfcTunnelPart/UNDER-CUTTUNNEL	IfcProtectiveArch should be contained in UNDER-CUTTUNNEL.

**EXPRESS Specification:**

ENTITY IfcProtectiveArch

SUBTYPE OF (IfcTunnelElement);  
 PreDefinedType: IfcProtectiveArchTypeEnum;  
 END\_ENTITY;

**Attribute definitions:**

PreDefinedType.

**10.4 Property Set Definition**

**10.4.1 Pset\_TunnelCommon**

Name: Pset\_TunnelCommon  
 Applicable Entities: IfcTunnel  
 Description: The common property set of tunnel.  
 Property Definitions: See Table 10.29.

**Table 10.29 Property definitions of Pset\_TunnelCommon**

Name	Type	Description
TunnelName	TypePropertySingleValue/IfcLabel	The name of the tunnel.
TunnelLength	TypePropertySingleValue/IfcLengthMeasure/m	The length of the tunnel.
MaximumDepthOfTunnel	TypePropertySingleValue/IfcLengthMeasure/m	The maximum depth of the tunnel.
SingleOrDoubleLine	TypePropertyEnumeratedValue/PEnum_ElementSingleOrDoubleLine:SINGLTRACKTUNNEL,DOUBLETRACKTUNNEL,BIFURCATIONTUNNEL	The tunnel is single line or double line or others.
MaximumFloodLevel	TypePropertySingleValue/IfcLengthMeasure/m	The maximum flood level of the area.
DesignSpeed	TypePropertySingleValue/IfcInteger/(Km/h)	The design speed of the tunnel.
AseismicLevel	TypePropertyEnumeratedValue/PEnum_ElementAseismicLevel(FortificationIntensity): 6,7,8,9	The fortification intensity of the tunnel.

**10.4.2 Pset\_PortalCommon**

Name: Pset\_PortalCommon  
 Applicable Entities: IfcTunnelPart/PORTAL  
 Description: The common property set of portal.  
 Property Definitions: See Table 10.30.

**Table 10.30 Property definitions of Pset\_PortalCommon**

Name	Type	Description
PortalType	TypePropertyEnumeratedValue/PEnum_ElementPortalType:HATSTYLEPORTAL,BELLSTYLEPORTAL,STRAIGHT	The type of the tunnel portal. TypePropertyEnumeratedValue: HATSTYLEPORTAL,

	HT-CUTPORTAL,POURCHAMFEREDPORTAL,BUFFEREDPORTAL,ENDWALLPORTAL	BELLSTYLEPORTAL,STRAIGHT-CUTPORTAL,POURCHAMFEREDPORTAL,BUFFEREDPORTAL,ENDWALLPORTAL.
Widening	TypePropertySingleValue/IfcLengthMeasure/m	The width value of the tunnel.

#### 10.4.3 Pset\_Open-cutTunnelCommon

Name: Pset\_Open-cutTunnelCommon

Applicable Entities: IfcTunnelPart/OPEN-CUTTUNNEL

Description: The common property set of open-cut tunnel.

Property Definitions: See Table 10.31.

**Table 10.31 Property definitions of Pset\_Open-cutTunnelCommon**

Name	Type	Description
Open-cutTunnelType	TypePropertySingleValue/IfcLabel	The type of open-cut tunnel.
Widening	TypePropertySingleValue/IfcLengthMeasure/m	The width value of the tunnel.

#### 10.4.4 Pset\_Under-cutTunnelCommon

Name: Pset\_Under-cutTunnelCommon

Applicable Entities: IfcTunnelPart/UNDER-CUTTUNNEL

Description: The common property set of under-cut tunnel.

Property Definitions: See Table 10.32.

**Table 10.32 Property definitions of Pset\_Under-cutTunnelCommon**

Name	Type	Description
Under-cutTunnelType	TypePropertySingleValue/IfcLabel	The type of under-cut tunnel.
Widening	TypePropertySingleValue/IfcLengthMeasure/m	The width value of the tunnel.

#### 10.4.5 Pset\_TunnelChamberCommon

Name: Pset\_TunnelChamberCommon

Applicable Entities: IfcTunnelPart/TUNNELCHAMBER

Description: The common property set of chamber.

Property Definitions: See Table 10.33.

**Table 10.33 Property definitions of Pset\_TunnelChamberCommon**

Name	Type	Description
------	------	-------------

Tunnel ChamberType	TypePropertyEnumeratedValue/PEnum_ElementTunnelChamberType:REFUGE,POWERTUNNELCHAMBER,COMMUNICATIONTUNNELCHAMBER,COMPREHENSIVETUNNELCHAMBER	The type of tunnel chamber. TypePropertyEnumeratedValue: REFUGE, POWERTUNNELCHAMBER, COMMUNICATIONTUNNELCHAMBER, COMPREHENSIVETUNNELCHAMBER.
Mileage	TypePropertySingleValue/IfcLabel	Mileage

#### 10.4.6 Pset\_ShedTunnelCommon

Name: Pset\_ShedTunnelCommon

Applicable Entities: IfcTunnelPart/SHEDTUNNEL

Description: The common property set of shed tunnel.

Property Definitions: See Table 10.34.

**Table 10.34 Property definitions of Pset\_ShedTunnelCommon**

Name	Type	Description
ShedTunnelType	TypePropertySingleValue/IfcLabel	The type of shed tunnel.
Widening	TypePropertySingleValue/IfcLengthMeasure/m	The width value of the tunnel.

#### 10.4.7 Pset\_TunnelAdvanceSupportCommon

Name: Pset\_TunnelAdvanceSupportCommon

Applicable Entities: IfcTunnelAdvanceSupport

Description: The common property set of advance support.

Property Definitions: See Table 10.35.

**Table 10.35 Property definitions of Pset\_TunnelAdvanceSupportCommon**

Name	Type	Description
TubeType	TypePropertySingleValue/IfcLabel	The type of the tube.
TubeDiameter	TypePropertySingleValue/IfcLengthMeasure/m	The diameter of the tube.
TubeWallThickness	TypePropertySingleValue/IfcLengthMeasure/m	The thickness of the tube wall.
TubeLength	TypePropertySingleValue/IfcLengthMeasure/m	The length of the tube.
TubeCircumferentialSpacing	TypePropertySingleValue/IfcLengthMeasure/m	The circumferential spacing of the tube.
TubeLongitudinalSpacing	TypePropertySingleValue/IfcLengthMeasure/m	The longitudinal spacing of the tube.



nalSpacing	e/m	the tube.
GroutingType	TypePropertyEnumeratedValue/PEnum_ElementGroutingType:RADIALGROUTING,ADVANCEDPERIMETERGROUTING,CURTAINGROUTING	The type of the grouting. TypePropertyEnumeratedValue: RADIALGROUTING, ADVANCEDPERIMETERGROUTING, CURTAINGROUTING.
GroutingMaterial	TypePropertySingleValue/IfcLabel	The material of the grouting.
SlurryRatio	TypePropertySingleValue/IfcRatioMeasure	The ratio of the material and water.
GroutingPressure	TypePropertySingleValue/IfcPressureMeasure/Pa	The grouting pressure.

#### 10.4.8 Pset\_TunnelPrimarySupportCommon

Name: Pset\_TunnelPrimarySupportCommon

Applicable Entities: IfcTunnelPrimarySupport

Description: The common property set of primary support.

Property Definitions: See Table 10.36.

**Table 10.36 Property definitions of Pset\_TunnelPrimarySupportCommon**

Name	Type	Description
TunnelPrimarySupportType	TypePropertySingleValue/IfcLabel	The type of the TunnelPrimarySupport.

#### 10.4.9 Pset\_SystemAncherBoltCommon

Name: Pset\_SystemAncherBoltCommon

Applicable Entities: IfcSystemAncherBolt

Description: The common property set of system anchor bolt.

Property Definitions: See Table 10.37.

**Table 10.37 Property definitions of Pset\_SystemAncherBoltCommon**

Name	Type	Description
CircumferentialSpacing	TypePropertySingleValue/IfcLengthMeasure/m	The circumferential spacing of the bolt.
LongitudinalSpacing	TypePropertySingleValue/IfcLengthMeasure/m	The longitudinal spacing of the bolt.
location	TypePropertyEnumeratedValue/PEnum_Elementlocation:ARCH,SIDEWALL,ARCHWALL	The location of the bolt. TypePropertyEnumeratedValue

		lue: ARCH, SIDEWALL, ARCHWALL.
GroutingMaterial	TypePropertySingleValue/IfcLabel	The grouting pressure.
SlurryRatio	TypePropertySingleValue/ IfcRatioMeasure	The ratio of the material and water.

#### 10.4.10 Pset\_SystemSteelArchCommon

Name: Pset\_SystemSteelArchCommon

Applicable Entities: IfcSystemSteelArch

Description: The common property set of system steel arch.

Property Definitions: See Table 10.38.

**Table 10.38 Property definitions of Pset\_SystemSteelArchCommon**

Name	Type	Description
LongitudinalSpacing	TypePropertySingleValue/IfcLengthMeasure/m	The longitudinal spacing of steel arch.

#### 10.4.11 Pset\_InitialSupportShotcreteCommon

Name: Pset\_InitialSupportShotcreteCommon

Applicable Entities: IfcInitialSupportShotcrete

Description: The common property set of initial support shotcrete.

Property Definitions: See Table 10.39.

**Table 10.39 Property definitions of Pset\_InitialSupportShotcreteCommon**

Name	Type	Description
Thickness	TypePropertySingleValue/IfcLengthMeasure/m	The thickness of the primary support.
InjectionProcess	TypePropertyEnumeratedValue/PEnum_ElementInjectionProcess:DRY SPRAYING, WETSPRAYING	The method of injection. TypePropertyEnumeratedValue: DRYSPRAYING, WETSPRAYING
ThicknessOfCover	TypePropertySingleValue/IfcLengthMeasure/m	The thickness of the concret out of the reinforcing bar or others.

#### 10.4.12 Pset\_TunnelLiningCommon

Name: Pset\_TunnelLiningCommon

Applicable Entities: IfcTunnelLining

Description: The common property set of tunnel lining.

Property Definitions: See Table 10.40.

**Table 10.40 Property definitions of Pset\_TunnelLiningCommon**

<b>Name</b>	<b>Type</b>	<b>Description</b>
Thickness	TypePropertySingleValue/IfcLengthMeasure/m	The thickness of the tunnel lining.
AntiPermeabilityLevel	TypePropertyEnumeratedValue/IfcLabel	Ability to resist water penetration under a certain pressure.

**10.4.13 Pset\_WaterproofLayerCommon**

Name: Pset\_WaterproofLayerCommon

Applicable Entities: IfcWaterproofLayer

Description: The common property set of waterproof layer.

Property Definitions: See Table 10.41.

**Table 10.41 Property definitions of Pset\_WaterproofLayerCommon**

<b>Name</b>	<b>Type</b>	<b>Description</b>
Useness	TypePropertySingleValue/IfcLabel	The useness of the layer.
Material	TypePropertySingleValue/IfcLabel	The material of the layer.
Process	TypePropertySingleValue/IfcLabel	The method of application.
Thickness	TypePropertySingleValue/IfcLengthMeasure/m	The thickness of the layer.

**10.4.14 Pset\_LevelingBlanketCommon**

Name: Pset\_LevelingBlanketCommon

Applicable Entities: IfcLevelingBlanket

Description: The common property set of leveling blanket.

Property Definitions: See Table 10.42.

**Table 10.42 Property definitions of Pset\_LevelingBlanketCommon**

<b>Name</b>	<b>Type</b>	<b>Description</b>
Useness	TypePropertySingleValue/IfcLabel	The useness of the layer.
Material	TypePropertySingleValue/IfcLabel	The material of the layer.
Process	TypePropertySingleValue/IfcLabel	The method of application.
Thickness	TypePropertySingleValue/IfcLengthMeasure/m	The thickness of the layer.

**10.4.15 Pset\_ProtectiveLayerCommon**

Name: Pset\_ProtectiveLayerCommon

Applicable Entities: IfcProtectiveLayer

Description: The common property set of protective layer.

Property Definitions: See Table 10.43.

**Table 10.43 Property definitions of Pset\_LevelingBlanketCommon**

Name	Type	Description
Useness	TypePropertySingleValue/IfcLabel	The useness of the layer.
Material	TypePropertySingleValue/IfcLabel	The material of the layer.
Process	TypePropertySingleValue/IfcLabel	The method of application.
Thickness	TypePropertySingleValue/IfcLengthMeasure/m	The thickness of the layer.

## 11. Drainage Schema

### 11.1 Schema Definition

The object in this schema is a network designed to receive, store, maintain, distribute, or control the flow of rainwater or groundwater near the railway subgrade, bridge and tunnel.

The drainage schema is developed by referencing the IfcDistributionSystem, IfcPipeSegmentand IfcDistributionChamberElement in IfcSharedBldgServiceElements schema of IFC4 and adding some necessary property sets.

### 11.2 Distribution System Definition

IfcDistributionSystem is used to represent a drainage ditch, a pipe or a groove. The predefined type “STORMWATER” of IfcDistributionSystemEnum is used when the flow media is surface water, such as subgrade drainage ditch, side gutter, overhead ditch, chute, intercepting ditch, etc. The predefined type “DRAINAGE” of IfcDistributionSystemEnum is used when the flow media is ground water, such as tunnel center ditch, circumferential french drain, longitudinal french drain, etc.

A new property set named “Pset\_DS\_DrainageDitchCommon” for IfcDistributionSystem is added to describe the types of the drairage ditch (see Table 11.1).

**Table 11.1 Property definitions of Pset\_DS\_DrainageDitchCommon**

Name	Data Type/Data Value	Description
Type	TypePropertyEnumeratedValue/IfcLabel	Type
	DrainageDitch	DrainageDitch Near embankment
	SideDitch	DrainageDitch Near cutting
	Gutter	DrainageDitch on the top of cutting roof
	CatchwaterDitch	Ditch to hold water on the side slope
	SubgradeSurfaceDrainage	Ditch on the surface of subgrade along the track
	SubgradeSurfaceDrainageCrossRailway	Ditch on the surface of subgrade crossing the track
	RoadDrainage	DrainageDitch Near road

	InterchangebridgeDrainage	DrainageDitch Near interchange bridge
	PermeableFrenchDrain	PermeableFrench drain
	SlopeDrain	Slope drain
	TunnelcenterDitch	Ditch in the center of tunnel
	CircumferentialFrenchDrain	Circumferential French Drain in the tunnel
	LongitudinalFrenchDrain	Longitudinal French Drain in the tunnel
	TransverseDrainpipe	Transverse Drainpipe in the tunnel
	VerticalDrainpipe	Vertical Drainpipe in the tunnel

### 11.3 Drainage Segment Definition

IfcPipeSegment is used to represent drainage ditch segment, pipe segment or groove segment. The predefined type “GUTTER” of IfcPipeSegmentEnum is used when the flow media is surface water.

A new property set named “Pset\_PS\_DitchSegmentCommon” for IfcPipeSegment is added to describe the types and properties of drainage ditch segment.

**Table 11.2 Property definitions of Pset\_PS\_DitchSegmentCommon**

Name	Data Type/Data Value	Description
Type	TypePropertyEnumeratedValue/IfcLabel	Type
	DrainageDitch	DrainageDitch Near embankment
	SideDitch	DrainageDitch Near cutting
	Gutter	DrainageDitch on the top of cutting roof
	CatchwaterDitch	Ditch to hold water on the side slope
	SubgradeSurfaceDrainage	Ditch on the surface of subgrade along the track
	SubgradeSurfaceDrainageCrossRailway	Ditch on the surface of subgrade crossing the track
	RoadDrainage	DrainageDitch Near road
	InterchangebridgeDrainage	DrainageDitch Near Interchange bridge
	PermeableFrenchDrain	Permeable French Drain
	SlopeDrain	Slope Drain
	TunnelcenterDitch	Ditch in the center of tunnel
	CircumferentialFrenchDrain	CircumferentialFrench Drain in the tunnel
	LongitudinalFrenchDrain	LongitudinalFrench Drain in the tunnel
	TransverseDrainpipe	Transverse Drainpipe in the tunnel

	VerticalDrainpipe	Vertical Drainpipe in the tunnel
ReferenceName	TypePropertySingleValue/IfcLabel	ReferenceName of Standard graph volume
ReferenceSectionName	TypePropertySingleValue/IfcLabel	ReferenceName of section of the Standard graph volume
Status	TypePropertyEnumeratedValue/IfcLabel NEW, EXISTING, DEMOLISH, TEMPORARY, OTHER, NOTKNOWN, UNSET	Status of the element, predominately used in renovation or retrofitting projects. The status can be assigned to as "New" - element designed as new addition, "Existing" - element exists and remains, "Demolish" - element existed but is to be demolished, "Temporary" - element will exists only temporary

#### 11.4 Chamber Facility

IfcDistributionChamberElement is used to represent the inspection well on a drainage ditch, and the predefined type “MANHOLE” should be selected from the IfcDistributionChamberElementTypeEnum.

IfcDistributionChamberElement is used to represent water collection sump on a drainage ditch, and the predefined type “SUMP” should be selected from the IfcDistributionChamberElementTypeEnum.

## 12. Track Schema

### 12.1 Schema Definition

This schema defines the basic data architecture of information model in track engineering domain. Track engineering includes tracks and its components on both main lines and station lines with ballasted track and ballastless track structures.

The basic data architecture of the track information model consists of IfcSpatialStructureElement, IfcElementAssembly, IfcElement and IfcElementComponent. The relationship between all the classes in the track schema is shown in Figure 12.1.

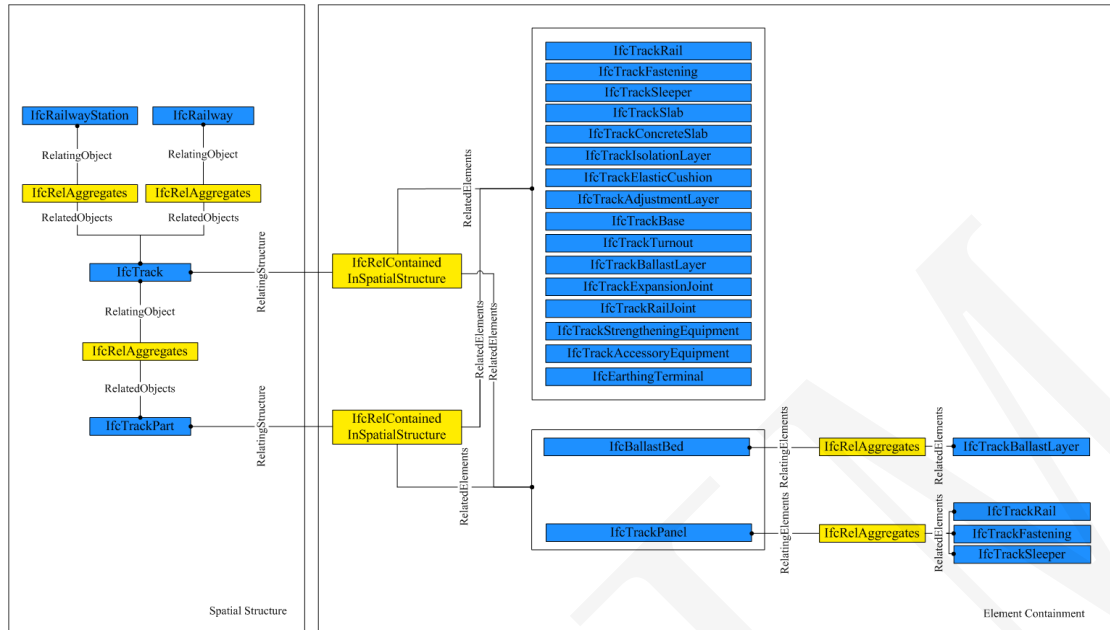

**Figure 12.1 Track composition**

Spatial structure elements in track engineering domain mainly include IfcTrack and IfcTrackPart.

Physical elements in track engineering domain mainly include IfcTrackRail, IfcTrackFastening, IfcTrackSleeper, IfcTrackSlab, IfcTrackConcreteSlab, IfcTrackIsolationLayer, IfcTrackElasticCushion, IfcTrackAdjustmentLayer, IfcTrackBase, IfcTrackTurnout, IfcTrackBallastLayer and IfcTrackExpansionJoint.

Element assemblies in track engineering domain mainly include IfcTrackPanel and IfcBallastBed.

Element components in track engineering domain mainly include IfcTrackRailJoint, IfcTrackStrengtheningEquipment and IfcTrackAccessoryEquipment.

Element components in railway engineering domain relevant to track engineering mainly include IfcEarthingTerminal.

### 12.1.1 Spatial Structure Elements of Track

Spatial structure elements in track engineering domain refer to the main parts in track spatial structures and their main composition structures, including IfcTrack and IfcTrackPart. The inheritance relationship of spatial structure elements in track engineering domain is shown in Figure 12.2.

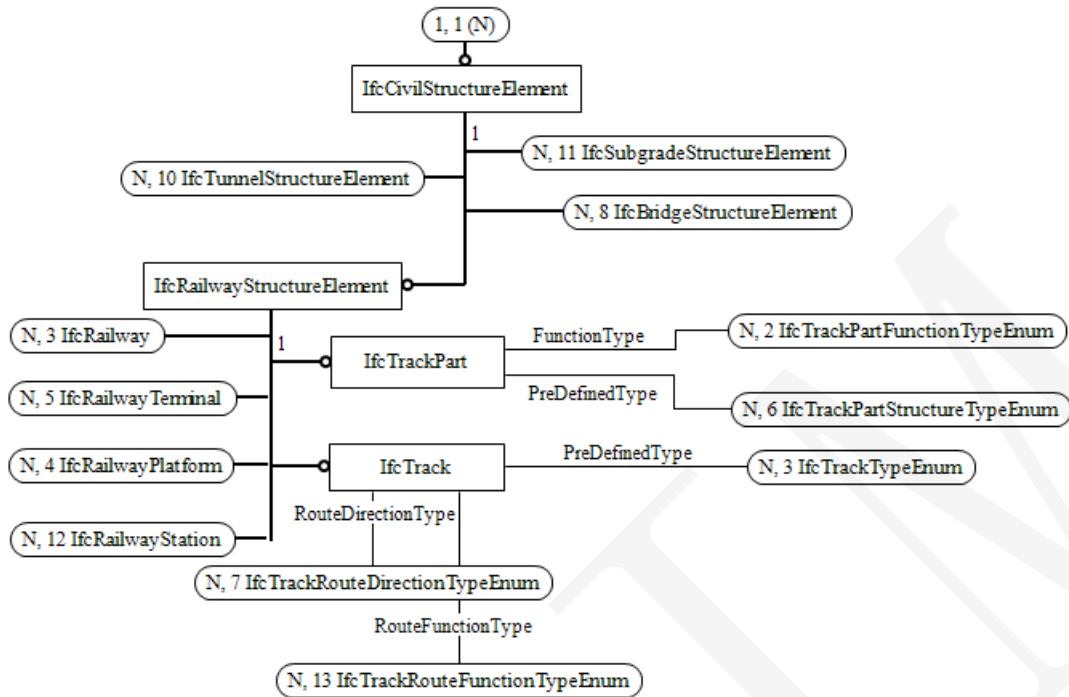

**Figure 12.2 EXPRESS-G diagram for the spatial structure elements of track**

IfcTrack refers to a track with certain functions and explicit start and end points, and may also refers to the track engineering containing one or more tracks. IfcTrack can be used to define one or several main line tracks and station line tracks with explicit functions in a station. An IfcTrack may contain one or more IfcTracks and may also contain one or more IfcTrackParts. IfcTrack may be contained in IfcRailway and IfcRailwayStaion.

IfcTrackPart refers to a segment of track which is part of the IfcTrack and has unique structural type and functional type. IfcTrackPart shall be contained in IfcTrack.

### 12.1.2 Physical Elements of Track

Physical elements in track engineering domain refer to important and common physical elements which are part of track structures, mainly including IfcTrackRail, IfcTrackFastening, IfcTrackSleeper, IfcTrackSlab, IfcTrackConcreteSlab, IfcTrackIsolationLayer, IfcTrackElasticCushion, IfcTrackAdjustmentLayer, IfcTrackBase, IfcTrackTurnout, IfcTrackBallastLayer and IfcTrackExpansionJoint. The inheritance relationship of physical elements in track engineering domain is shown in Figure 12.3.



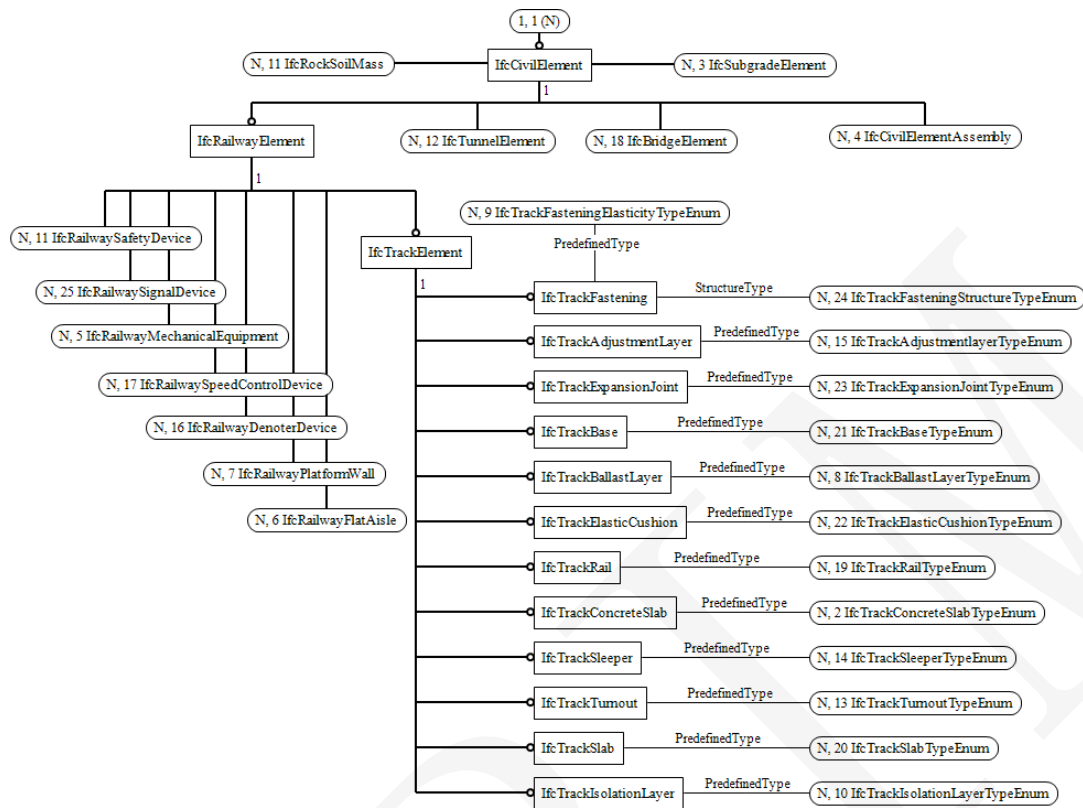

**Figure 12.3 EXPRESS-G diagram for physical elements of track**

IfcTrackRail refers to a segment of rails. Rail is a main part of track structure, which directly supports and guides wheels and supplies wheels with continuous and smooth rolling surface with minimum resistance. And it leads locomotives and rolling stocks forward, bears heavy load of wheels, transfers it to the sub-structures and could be used as track circuit as well. IfcTrackRail, IfcTrackFastening and IfcTrackSleeper may comprise IfcTrackPanel. IfcTrackRail should be contained in IfcTrackPart, and may be contained in IfcTrack.

IfcTrackFastening refers to a set of track fastening. Fastening is a connecting element which buckle rails on sleepers or other sub-structures. IfcTrackFastening, IfcTrackRail and IfcTrackSleeper may be composed into IfcTrackPanel. IfcTrackFastening should be contained in IfcTrackPart, and may be contained in IfcTrack.

IfcTrackSleeper refers to a piece of track sleeper. Track sleeper is an element to support rails, to maintain gauges and to transfer load to the ballast bed or the track concrete slab. IfcTrackSleeper, IfcTrackFastening and IfcTrackRail may be composed into IfcTrackPanel. IfcTrackSleeper should be contained in IfcTrackPart, and may be contained in IfcTrack.

IfcTrackSlab refers to a piece of track slab. Track slab is a prefabricated reinforced concrete slab or a prestressed reinforced concrete slab, which is a main element of slab track. It transfers the load from rails and fastenings to sub-structures uniformly and from longitudinal and lateral load of track structures to displacement-stopping structures. IfcTrackSlab shall only appear in ballastless

track structures. IfcTrackSlab should be contained in IfcTrackPart, and may be contained in IfcTrack.

IfcTrackConcreteSlab refers to a piece of track concrete slab. Track concrete slab is an integral reinforced concrete layer cast in-situ, in which bi-block sleepers, concrete turnout sleepers or other sleepers are embedded. IfcTrackConcreteSlab shall only appear in ballastless track structures. IfcTrackConcreteSlab should be contained in IfcTrackPart, and may be contained in IfcTrack.

IfcTrackIsolationLayer refers to a piece of track isolation layer. Isolation layer is a structure layer placed on the top surface of track bases. It may implement functions of damage repair of track superstructure under special circumstances and coordinate temperature deformation. IfcTrackIsolationLayer shall only appear in ballastless track structures. IfcTrackIsolationLayer should be contained in IfcTrackPart, and may be contained in IfcTrack.

IfcTrackElasticCushion refers to a piece of track elastic cushion. Elastic cushion is a kind of layer set on trough sides of a concrete base, which is used for mitigating the impact of longitudinal and lateral load on track structures. IfcTrackElasticCushion shall only appear in ballastless track structures. IfcTrackElasticCushion should be contained in IfcTrackPart, and may be contained in IfcTrack.

IfcTrackAdjustmentLayer refers to a piece of adjustment layer. Adjustment layer is a concrete layer or a mortar layer cast or paved in-situ, which is used for supporting track slabs or track concrete slabs. IfcTrackAdjustmentLayer shall only appear in ballastless track structures. IfcTrackAdjustmentLayer should be contained in IfcTrackPart, and may be contained in IfcTrack.

IfcTrackBase refers to a piece of concrete base. Concrete base is a kind of reinforced foundation cast in-situ, which is used for supporting track slabs or track concrete slabs. IfcTrackBase shall only appear in ballastless track structures. IfcTrackBase should be contained in IfcTrackPart, and may be contained in IfcTrack.

IfcTrackTurnout refers to a set of turnouts. Turnout is a facility to transform one track into two or more tracks. IfcTrackTurnout should be contained in all the types of IfcTrackPart except the type of WITHNOTURNOUT and may be contained in IfcTrack.

IfcTrackBallastLayer refers to one ballast layer. Ballast layer is a structure layer which comprises different kinds of granular materials with different particle size grading, such as crushed stones, pebbles, sands, slags and so on. It can directly support or fix sleepers, transfer loads and play a role in drainage system, etc. One or more IfcTrackBallastLayer may be composed into an IfcBallastBed. IfcTrackBallastLayer shall only appear in ballasted track structures. IfcTrackBallastLayer should be contained in IfcTrackPart, and may be contained in IfcTrack.

IfcTrackExpansionJoint refers to a set of rail expansion joint. Rail expansion joint is a facility to adjust the expansion of rails. IfcTrackExpansionJoint should be contained in IfcTrackPart, and may be contained in IfcTrack.

### 12.1.3 Element Assemblies of Track

Element assemblies in track engineering domain refer to the assemblies consisting in physical elements or the combination of physical elements and assemblies. They always have certain functions and may play specific roles in track structures, including IfcBallastBed and IfcTrackPanel. Inheritance relationships of element assemblies in track engineering domain are shown in Figure 12.4.

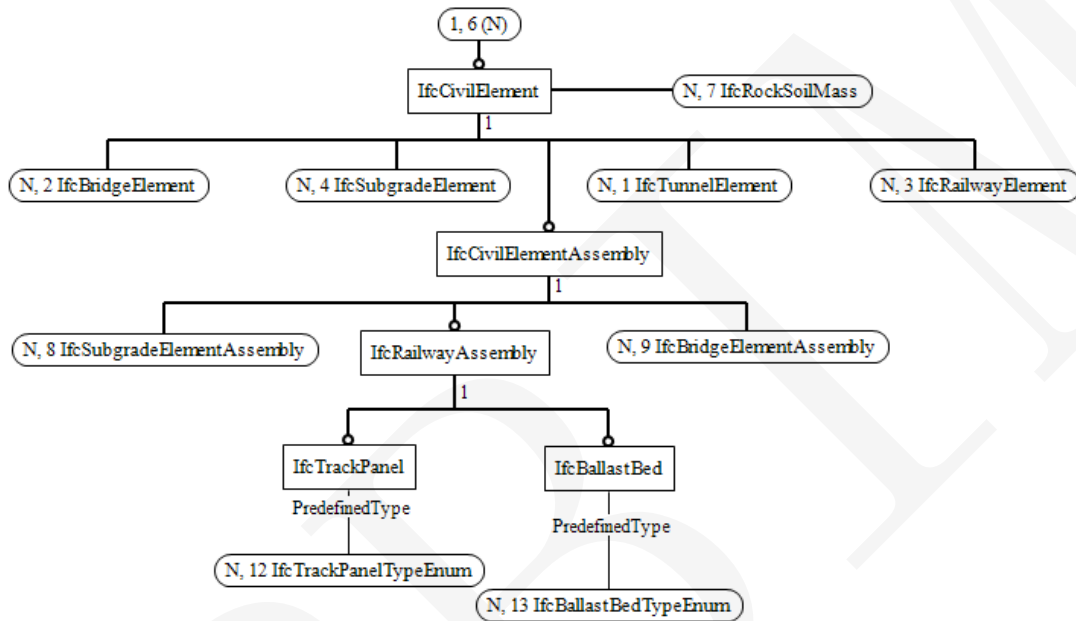

**Figure 12.4 EXPRESS-G diagram for element assemblies of track**

IfcBallastBed is a part of the track structure, which supports and fixes sleepers and transfers and distributes its load to the top surface of the sub-structures. IfcBallastBed shall only appear in ballasted track structures. One IfcBallastBed may contain one or more IfcTrackBallastLayer. IfcBallastBed should be contained in IfcTrackPart, and may be contained in IfcTrack.

IfcTrackPanel is an element assembly which consists of (two pieces of) rails, sleepers and fastenings which buckle rails on sleepers. IfcTrackPanel may be comprised of IfcTrackRail, IfcTrackFastening and IfcTrackSleeper. IfcTrackPanel should be contained in IfcTrackPart, and may be contained in IfcTrack.

### 12.1.4 Element Components of Track

Element components in track engineering domain refer to minor items to play auxiliary roles of strengthening and connecting, which are added to or included in physical elements in track engineering domain. They mainly include IfcTrackRailJoint, IfcTrackStrengtheningEquipment and IfcTrackAccessoryEquipment. Inheritance relationships of element components in track engineering domain are shown in Figure 12.5.

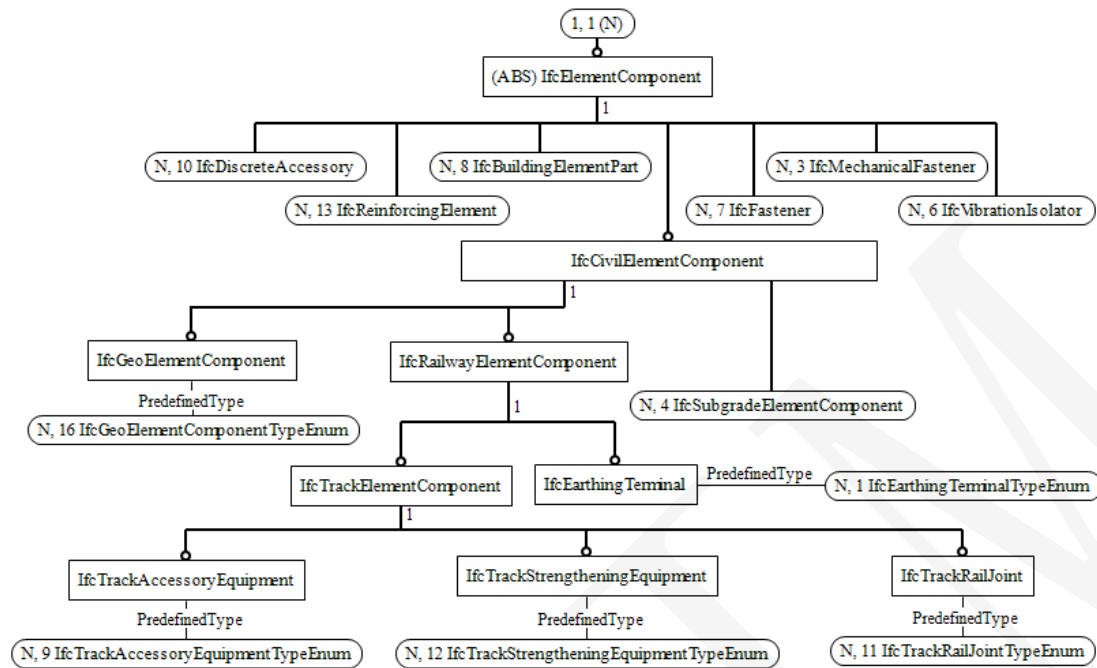

**Figure 12.5 EXPRESS-G diagram for element components of track**

IfcTrackRailJoint refers to a set of rail joint. Rail joint is a kind of connecting component, which is used at joints between adjacent rails. IfcTrackRailJoint should be contained in IfcTrackPart, and may be contained in IfcTrack.

IfcTrackStrengtheningEquipment refers to one strengthening equipment for track structures. Strengthening equipment for track structures is a kind of facility installed on track structures, which improves the rail's ability to resist longitudinal and lateral slippage. By properties of predefined types, strengthening equipment for track structures could be further subdivided into ANTICREEPER, ANTICREEPSTRUT, GAUGETIEROD, RAILBRACE, and so on. IfcTrackStrengtheningEquipment should be contained in IfcTrackPart, and may be contained in IfcTrack.

IfcTrackAccessoryEquipment refers to one accessory equipment for track structures. It is a kind of facility installed on or nearby track structures, which plays a specific role of sealing, protection and absorption, etc. By properties of predefined types, accessory equipment for track structures could be further subdivided into SEALINGSTRIPBETWEENSLEEPERS, STEELSPRINGVIBRATIONISOLATOR, RUBBERDAMPINGPAD, SOUNDABSORBINGPANEL, GUARDRAIL, and so on. IfcTrackAccessoryEquipment should be contained in IfcTrackPart, and may be contained in IfcTrack.

### 12.1.5 Other Element Components

Other element components refer to minor items playing auxiliary roles of strengthening and connecting, which are appended to or included in physical elements in track engineering domain or applied in other engineering. It mainly includes IfcEarthingTerminal. Inheritance relationships of

other element components are shown in Figure 12.5.

IfcEarthingTerminal refers to a terminal connected to a grounding object. IfcEarthingTerminal should be contained in IfcTrackPart, and may be contained in IfcTrack.

## 12.2 Type Definition

### 12.2.1 IfcTrackTypeEnum

IfcTrackTypeEnum is an enumeration of track types, which defines the different functional types of track.

#### **Enumerated Item Definitions:**

MAINTRACK;  
CONNECTINGLINE;  
RUNNINGTRACKFORMULTIPLEUNIT;  
UNTWININGLINE;  
RECEIVINGDEPATURETRACK;  
SWITCHINGLEAD;  
CATCHSIDING;  
FREIGHTTRACK;  
CLASSIFICATIONTRACK;  
LOCOMOTIVERUNNINGTRACK;  
REFUGESIDING;  
ROUNDABOUTLINE;  
ROLLINGFORBIDDENTRACK;  
ROLLINGTRACK;  
LOCOMOTIVESERVICETRACK;  
LOCOMOTIVEHOLDTRACK;  
STORAGETRACK;  
REPAIRSIDING;  
USERDEFINED;  
NOTDEFINED.

#### **EXPRESS Specification:**

TYPE IfcTrackTypeEnum = ENUMERATION OF  
(MAINTRACK  
,CONNECTINGLINE  
,RUNNINGTRACKFORMULTIPLEUNIT  
,UNTWININGLINE  
,RECEIVINGDEPATURETRACK  
,SWITCHINGLEAD

```

,CATCHSIDING
,FREIGHTTRACK
,CLASSIFICATIONTRACK
,LOCOMOTIVERUNNINGTRACK
,REFUGESIDING
,ROUNDABOUTLINE
,ROLLINGFORBIDDENRACK
,ROLLINGTRACK
,LOCOMOTIVESERVICETRACK
,LOCOMOTIVEHOLDTRACK
,STORAGETRACK
,REPAIRSIDING
,USERDEFINED
,NOTDEFINED
);
END_TYPE;

```

### 12.2.2 IfcTrackRouteDirectionTypeEnum

IfcTrackRouteDirectionTypeEnum is an enumeration of directional types of track route, which defines the different directional types of track route.

#### Enumerated Item Definitions:

```

UPDIRECTIONROUTE;
DOWNDIRECTIONROUTE;
EITHERDIRECTIONALROUTE.

```

#### EXPRESS Specification:

```

TYPE IfcTrackRouteDirectionTypeEnum= ENUMERATION OF
  (UPDIRECTIONROUTE
  ,DOWNDIRECTIONROUTE
  , EITHERDIRECTIONALROUTE
  );
END_TYPE;

```

### 12.2.3 IfcTrackRouteFunctionTypeEnum

IfcTrackRouteFunctionTypeEnum is an enumeration of functional types of track route, which defines the different functional types of track route.

#### Enumerated Item Definitions:

```

PASSENGERLINE;
FREIGHTLINE;
PASSENGERFREIGHTLINE;
ENTERDEPOTLINEFORLOCOMOTIVE;
EXITDEPOTLINEFORLOCOMOTIVE.

```

**EXPRESS Specification:**

```
TYPE IfcTrackRouteFunctionTypeEnum= ENUMERATION OF
(PASSENGERLINE
, FREIGHTLINE
, PASSENGERFREIGHTLINE
, ENTERDEPOTLINEFORLOCOMOTIVE
, EXITDEPOTLINEFORLOCOMOTIVE
);
END_TYPE;
```

**12.2.4 IfcTrackPartStructureTypeEnum**

IfcTrackPartStructureTypeEnum is an enumeration of the structural types of track part, which defines the different structural types of track part foundation.

**Enumerated Item Definitions:**

```
ONSUBGRADE;
ONBRIDGE;
INTUNNEL;
TRANSITIONSECTION;
ONSPECIALFOUNDATION;
USERDEFINED;
NOTDEFINED.
```

**EXPRESS Specification:**

```
TYPE IfcTrackPartStructureTypeEnum= ENUMERATION OF
(ONSUBGRADE
, ONBRIDGE
, INTUNNEL
, TRANSITIONSECTION
, ONSPECIALFOUNDATION
, USERDEFINED
, NOTDEFINED
);
END_TYPE;
```

**12.2.5 IfcTrackPartFunctionTypeEnum**

IfcTrackPartFunctionTypeEnum is an enumeration of functional types of track part, which defines the different functional types of track part.

**Enumerated Item Definitions:**

```
WITHTURNOUT;
WITHNOTURNOUT.
```

**EXPRESS Specification:**

```
TYPE IfcTrackPartFunctionTypeEnum= ENUMERATION OF
  (WITHTURNOUT
  , WITHNOTURNOUT
  );
END_TYPE;
```

**12.2.6 IfcTrackRailTypeEnum**

IfcTrackRailTypeEnum is an enumeration of rail types, which defines the different types of rails.

**Enumerated Item Definitions:**

```
HEAVYDUTYTRACK;
LIGHTDUTYTRACK;
USERDEFINED;
NOTDEFINED.
```

**EXPRESS Specification:**

```
TYPE IfcTrackRailTypeEnum= ENUMERATION OF
  (HEAVYDUTYTRACK
  , LIGHTDUTYTRACK
  , USERDEFINED
  , NOTDEFINED
  );
END_TYPE;
```

**12.2.7 IfcTrackFasteningElasticityTypeEnum**

IfcTrackFasteningElasticityTypeEnum is an enumeration of fastening types, which defines the different types of fastening clips.

**Enumerated Item Definitions:**

```
ELASTICRAILFASTENING;
RIGIDRAILFASTENING.
```

**EXPRESS Specification:**

```
TYPE IfcTrackFasteningElasticityTypeEnum= ENUMERATION OF
  (ELASTICRAILFASTENING
  , RIGIDRAILFASTENING
  );
END_TYPE;
```

**12.2.8 IfcTrackFasteningStructureTypeEnum**

IfcTrackFasteningStructureTypeEnum is an enumeration of structural types of fastening



components, which defines the different structural types of fastening components.

**Enumerated Item Definitions:**

SEPARATEDRAILFASTENING;  
SEMISEPARATEDRAILFASTENING;  
NONSEPARATEDRAILFASTENING.

**EXPRESS Specification:**

```
TYPE IfcTrackFasteningStructureTypeEnum= ENUMERATION OF
    (SEPARATEDRAILFASTENING
    , SEMISEPARATEDRAILFASTENING
    , NONSEPARATEDRAILFASTENING
    );
END_TYPE;
```

### 12.2.9 IfcTrackSleeperTypeEnum

IfcTrackSleeperTypeEnum is an enumeration of sleeper types, which defines the different structural types of sleepers.

**Enumerated Item Definitions:**

CONCRETESLEEPER;  
WOODENSLEEPER;  
BROADCONCRETESLEEPER;  
CONCRETELASTICSLEEPER;  
CAPACITIVESLEEPER;  
ELECTRICINSULATEDSLEEPER;  
BIBLOCKSLEEPER;  
SUPPORTINGBLOCK;  
USERDEFINED;  
NOTDEFINED.

**EXPRESS Specification:**

```
TYPE IfcTrackSleeperTypeEnum= ENUMERATION OF
    ( CONCRETESLEEPER
    , WOODENSLEEPER
    , BROADCONCRETESLEEPER
    , CONCRETELASTICSLEEPER
    , CAPACITIVESLEEPER
    , ELECTRICINSULATEDSLEEPER
    , BIBLOCKSLEEPER
    , SUPPORTINGBLOCK
    , USERDEFINED
```

```
, NOTDEFINED
);
END_TYPE;
```

#### 12.2.10 IfcTrackSlabTypeEnum

IfcTrackSlabTypeEnum is an enumeration of track slab types, which defines the different types of track slabs from the perspective of being pre-stressed or not.

**Enumerated Item Definitions:**

```
NONPRESTRESSEDTRACKSLAB;
UNIDIRECTIONALPRESTRESSEDTRACKSLAB;
BIDIRECTIONALPRESTRESSEDTRACKSLAB;
USERDEFINED;
NOTDEFINED.
```

**EXPRESS Specification:**

```
TYPE IfcTrackSlabTypeEnum= ENUMERATION OF
( NONPRESTRESSEDTRACKSLAB
, UNIDIRECTIONALPRESTRESSEDTRACKSLAB
, BIDIRECTIONALPRESTRESSEDTRACKSLAB
, USERDEFINED
, NOTDEFINED
);
END_TYPE;
```

#### 12.2.11 IfcTrackConcreteSlabTypeEnum

IfcTrackConcreteSlabTypeEnum is an enumeration of track concrete slab types.

**Enumerated Item Definitions:**

```
USERDEFINED;
NOTDEFINED.
```

**EXPRESS Specification:**

```
TYPE IfcTrackConcreteSlabTypeEnum= ENUMERATION OF
( USERDEFINED
, NOTDEFINED
);
END_TYPE;
```

#### 12.2.12 IfcTrackIsolationLayerTypeEnum

IfcTrackIsolationLayerTypeEnum is an enumeration of track isolation layer types.

**Enumerated Item Definitions:**

```
USERDEFINED;
NOTDEFINED.
```

**EXPRESS Specification:**

```
TYPE IfcTrackIsolationLayerTypeEnum= ENUMERATION OF
  ( USERDEFINED
    , NOTDEFINED
  );
END_TYPE;
```

**12.2.13 IfcTrackElasticCushionTypeEnum**

IfcTrackElasticCushionTypeEnum is an enumeration of track elastic cushion types.

**Enumerated Item Definitions:**

```
USERDEFINED;
NOTDEFINED.
```

**EXPRESS Specification:**

```
TYPE IfcTrackElasticCushionTypeEnum= ENUMERATION OF
  ( USERDEFINED
    , NOTDEFINED
  );
END_TYPE;
```

**12.2.14 IfcTrackAdjustmentlayerTypeEnum**

IfcTrackAdjustmentlayerTypeEnum is an enumeration of track adjustment layer types.

**Enumerated Item Definitions:**

```
USERDEFINED;
NOTDEFINED.
```

**EXPRESS Specification:**

```
TYPE IfcTrackAdjustmentlayerTypeEnum= ENUMERATION OF
  ( USERDEFINED
    , NOTDEFINED
  );
END_TYPE;
```

**12.2.15 IfcTrackBaseTypeEnum**

IfcTrackBaseTypeEnum is an enumeration of track base types.

**Enumerated Item Definitions:**

```
USERDEFINED;
NOTDEFINED.
```

**EXPRESS Specification:**

```
TYPE IfcTrackBaseTypeEnum= ENUMERATION OF
```

```
( USERDEFINED
, NOTDEFINED
);
END_TYPE;
```

#### 12.2.16 IfcTrackTurnoutTypeEnum

IfcTrackTurnoutTypeEnum is an enumeration of turnout types, which defines the different structural types of turnout.

**Enumerated Item Definitions:**

```
LEFTHANDTURNOUT;
RIGHTHANDTURNOUT;
SYMMETRICALTURNOUT;
SLIPTOURNOUT;
SCISSORSCROSSING;
COMBINATIONOFSLIPTURNOUTANDSCISSORSCROSSING;
USERDEFINED;
NOTDEFINED.
```

**EXPRESS Specification:**

```
TYPE IfcTrackTurnoutTypeEnum= ENUMERATION OF
( LEFTHANDTURNOUT
, RIGHTHANDTURNOUT
, SYMMETRICALTURNOUT
, SLIPTOURNOUT
, SCISSORSCROSSING
, COMBINATIONOFSLIPTURNOUTANDSCISSORSCROSSING
, USERDEFINED
, NOTDEFINED
);
END_TYPE;
```

#### 12.2.17 IfcTrackBallastLayerTypeEnum

IfcTrackBallastLayerTypeEnum is an enumeration of functional types of the ballast layer, which defines the different functional types of the ballast layer.

**Enumerated Item Definitions:**

```
TOPBALLAST;
SUBBALLAST;
SPACEFILLEDBALLAST;
USERDEFINED;
NOTDEFINED.
```

**EXPRESS Specification:**

```
TYPE IfcTrackBallastLayerTypeEnum= ENUMERATION OF
  (TOPBALLAST
  , SUBBALLAST
  , SPACEFILLEDBALLAST
  , USERDEFINED
  , NOTDEFINED
  );
END_TYPE;
```

**12.2.18 IfcTrackExpansionJointTypeEnum**

IfcTrackExpansionJointTypeEnum is an enumeration of expansion joint types, which defines the different structural types of the expansion joint.

**Enumerated Item Definitions:**

```
SINGLEDIRECTION;
BIDIRECTION.
```

**EXPRESS Specification:**

```
TYPE IfcTrackExpansionJointTypeEnum= ENUMERATION OF
  (SINGLEDIRECTION
  , BIDIRECTION
  );
END_TYPE;
```

**12.2.19 IfcBallastBedTypeEnum**

IfcBallastBedTypeEnum is an enumeration of ballast bed types.

**Enumerated Item Definitions:**

```
USERDEFINED;
NOTDEFINED.
```

**EXPRESS Specification:**

```
TYPE IfcBallastBedTypeEnum= ENUMERATION OF
  ( USERDEFINED
  , NOTDEFINED
  );
END_TYPE;
```

**12.2.20 IfcTrackPanelTypeEnum**

IfcTrackPanelTypeEnum is an enumeration of track panel types.

**Enumerated Item Definitions:**

```
USERDEFINED;
```

NOTDEFINED.

**EXPRESS Specification:**

```
TYPE IfcTrackPanelTypeEnum= ENUMERATION OF
  ( USERDEFINED
    , NOTDEFINED
  );
END_TYPE;
```

**12.2.21 IfcTrackRailJointTypeEnum**

IfcTrackRailJointTypeEnum is an enumeration of rail joint types, which defines the different functional types of the rail joint.

**Enumerated Item Definitions:**

```
RAILJOINTFASTENING;
COMPROMISINGJOINT;
INSULATEDJOINT;
WELDEDJOINT;
CONDUCTIVEJOINT;
UNCHANGEABLEJOINT;
USERDEFINED;
NOTDEFINED.
```

**EXPRESS Specification:**

```
TYPE IfcTrackRailJointTypeEnum= ENUMERATION OF
  (RAILJOINTFASTENING
    , COMPROMISINGJOINT
    , INSULATEDJOINT
    , WELDEDJOINT
    , CONDUCTIVEJOINT
    , UNCHANGEABLEJOINT
    , USERDEFINED
    , NOTDEFINED
  );
END_TYPE;
```

**12.2.22 IfcTrackStrengtheningEquipmentTypeEnum**

IfcTrackStrengtheningEquipmentTypeEnum is an enumeration of track strengthening equipment types, which defines the different structural types of the track strengthening equipment.

**Enumerated Item Definitions:**

```
ANTICREEPER;
ANTICREEPSTRUT;
```

GAUGETIEROD;  
RAILBRACE;  
USERDEFINED;  
NOTDEFINED.

**EXPRESS Specification:**

TYPE IfcTrackStrengtheningEquipmentTypeEnum= ENUMERATION OF  
(ANTICREEPER  
, ANTICREEPSTRUT  
, GAUGETIEROD  
, RAILBRACE  
, USERDEFINED  
, NOTDEFINED  
);  
END\_TYPE;

**12.2.23 IfcTrackAccessoryEquipmentTypeEnum**

IfcTrackAccessoryEquipmentTypeEnum is an enumeration of track accessory equipment types, which defines the different functional types of the track accessory equipment.

**Enumerated Item Definitions:**

SEALINGSTRIPBETWEENSLEEPERS;  
STEELSPRINGVIBRATIONISOLATOR;  
RUBBERDAMPINGPAD;  
SOUNDABSORBINGPANEL;  
GUARDRAIL;  
USERDEFINED;  
NOTDEFINED.

**EXPRESS Specification:**

TYPE IfcTrackAccessoryEquipmentTypeEnum= ENUMERATION OF  
(SEALINGSTRIPBETWEENSLEEPERS  
, STEELSPRINGVIBRATIONISOLATOR  
, RUBBERDAMPINGPAD  
, SOUNDABSORBINGPANEL  
, GUARDRAIL  
, USERDEFINED  
, NOTDEFINED  
);  
END\_TYPE;

**12.2.24 IfcEarthingTerminalTypeEnum**

IfcEarthingTerminalTypeEnum is an enumeration of earthing terminal types.

**Enumerated Item Definitions:**

USERDEFINED;

NOTDEFINED.

**EXPRESS Specification:**

```
TYPE IfcEarthingTerminalTypeEnum= ENUMERATION OF
    ( USERDEFINED
      , NOTDEFINED
    );
END_TYPE;
```

**12.3 Entity Definition**

**12.3.1 IfcTrack**

IfcTrack refers to a track with certain functions and explicit start and end points, and may also refers to the track engineering containing one or more tracks. IfcTrack can be used to define one or several main line tracks and station line tracks with explicit functions in a station. An IfcTrack may contain one or more IfcTracks and may also contain one or more IfcTrackParts. IfcTrack may be contained in IfcRailway and IfcRailwayStation.

**Table 12.1 IfcTrack spatial composition**

Spatial Composite	Description
IfcRailway	IfcTrack is a part of IfcRailway.
IfcRailwayStation	IfcTrack may be a part of IfcRailwayStation.

**Table 12.2 IfcTrack spatial decomposition**

Spatial Parts	Description
IfcTrackPart	IfcTrack is comprised of one or more IfcTrackParts.

**Table 12.3 IfcTrack spatial containment**

Contained Entities	Description
IfcTrackElement	All of the physical elements in track engineering domain may be contained in IfcTrack.
IfcBallastBed	IfcBallastBed may be contained in IfcTrack.
IfcTrackPanel	IfcTrackPanel may be contained in IfcTrack.
IfcTrackElementComponent	All of the element components in track engineering domain may be contained in IfcTrack.
IfcEarthingTerminal	IfcEarthingTerminal may be contained in IfcTrack.

**Table 12.4 Property sets for IfcTrack**

PredefinedType	Name
----------------	------



	Pset_TrackCommon
--	------------------

**EXPRESS Specification:**

```

ENTITY IfcTrack
  SUBTYPE OF (IfcRailwayStructureElement);
    PreDefinedType: IfcTrackTypeEnum;
    RouteDirectionType: IfcTrackRouteDirectionTypeEnum;
    RouteFunctionType: IfcTrackRouteFunctionTypeEnum;
END_ENTITY;

```

**Attribute definitions:**

PreDefinedType: It defines the functional types of a track, such as MAINTRACK, CONNECTINGLINE, RUNNINGTRACKFORMULTIPLEUNIT, UNTWININGLINE, RECEIVINGDEPARTURETRACK, SWITCHINGLEAD, CATCHSIDING, FREIGHTTRACK, CLASSIFICATIONTRACK, LOCOMOTIVERUNNINGTRACK, REFUGESIDING, ROUNDABOUTLINE, ROLLINGFORBIDDENRACK, ROLLINGTRACK, LOCOMOTIVESERVICETRACK, LOCOMOTIVEHOLDTRACK, STORAGE TRACK, REPAIRSIDING, etc.

RouteDirectionType: It defines the permissible directions of a train on a track route, such as UPDIRECTIONROUTE, DOWNDIRECTIONROUTE, and EITHERDIRECTIONALROUTE.

RouteFunctionType: It defines the permissible train types on a track route, such as PASSENGERLINE, FREIGHTLINE, PASSENGERFREIGHTLINE, ENTERDEPOTLINEFORLOCOMOTIVE, EXITDEPOTLINEFORLOCOMOTIVE, etc.

**12.3.2 IfcTrackPart**

IfcTrackPart refers to a segment of track engineering which is part of the IfcTrack and has a unique structural type and functional type.

**Table 12.5 IfcTrackPart spatial composition**

Spatial Composite	Description
IfcTrack	IfcTrackPart is a part of IfcTrack.

**Table 12.6 IfcTrackPart spatial containment**

Contained Entities	Description
IfcTrackElement	All of the physical elements in track engineering domain may be contained in IfcTrackPart.
IfcBallastBed	IfcBallastBed may be contained in IfcTrackPart.
IfcTrackPanel	IfcTrackPanel may be contained in IfcTrackPart.
IfcTrackElementComponent	All of the element components in track engineering domain may be contained in IfcTrackPart.
IfcEarthingTerminal	IfcEarthingTerminal may be contained in IfcTrackPart.

**Table 12.7 Property sets for IfcTrackPart**

PredefinedType	Name
	Pset_TrackPartCommon

**EXPRESS Specification:**

ENTITY IfcTrackPart  
 SUBTYPE OF (IfcRailwayStructureElement);  
     PreDefinedType: IfcTrackPartStructureTypeEnum;  
     FunctionType: IfcTrackPartFunctionTypeEnum;  
 END\_ENTITY;

**Attribute definitions:**

PreDefinedType: It defines the different structural types of track part foundation, such as ONSUBGRADE, ONBRIDGE, INTUNNEL, TRANSITIONSECTION, ONSPECIALFOUNDATION, etc.

FunctionType: It defines whether a track part contains a turnout structure or not, such as WITHTURNOUT and WITHNOTURNOUT.

**12.3.3 IfcTrackElement**

IfcTrackElement refers to specific elements in track engineering domain. And it is the superclass of all the physical elements in track engineering domain.

**EXPRESS Specification:**

ENTITY IfcTrackElement  
 SUPERTYPE OF (ONEOF  
     (IfcTrackRail,IfcTrackFastening,IfcTrackSleeper,IfcTrackSlab,IfcTrackConcreteSlab,IfcTrackIsolation  
 Layer,IfcTrackElasticCushion,IfcTrackAdjustmentLayer,IfcTrackBase,IfcTrackTurnout,IfcTrackBallastLayer,IfcTrackExpansionJoint))  
 SUBTYPE OF (IfcRailwayElement);  
 END\_ENTITY;

**12.3.4 IfcTrackRail**

IfcTrackRail is a main part of track structure, which directly supports and guides wheels and supplies wheels with continuous and smooth rolling surface with minimum resistance. And it leads locomotives and rolling stocks forward, bears heavy load of wheels, transfers the load to the sub-structures and could be used as track circuit as well. IfcTrackRail, IfcTrackFastening and IfcTrackSleeper may be composed into IfcTrackPanel.

**Table 12.8 Property sets for IfcTrackRail**

PredefinedType	Name
	Pset_RailCommon

**Table 12.9 IfcTrackRail contained in spatial structure**

Spatial Structure	Description
-------------------	-------------

IfcTrackPart	IfcTrackRail should be contained in IfcTrackPart.
IfcTrack	IfcTrackRail may be contained in IfcTrack.

**EXPRESS Specification:**

ENTITY IfcTrackRail  
SUBTYPE OF (IfcTrackElement);  
PreDefinedType: IfcTrackRailTypeEnum;  
END\_ENTITY;

**Attribute definitions:**

PreDefinedType: It defines the different types of rails, such as HEAVYDUTYTRACK and LIGHTDUTYTRACK, etc.

**12.3.5 IfcTrackFastening**

IfcTrackFastening is a connecting element to buckle rails on sleepers or other sub-structures. IfcTrackFastening, IfcTrackRail and IfcTrackSleeper may be composed into IfcTrackPanel.

**Table 12.10 Property sets for IfcTrackFastening**

PredefinedType	Name
	Pset_TrackFasteningCommon

**Table 12.11 IfcTrackFastening contained in spatial structure**

Spatial Structure	Description
IfcTrackPart	IfcTrackFastening should be contained in IfcTrackPart.
IfcTrack	IfcTrackFastening may be contained in IfcTrack.

**EXPRESS Specification:**

ENTITY IfcTrackFastening  
SUBTYPE OF (IfcTrackElement);  
PreDefinedType: IfcTrackFasteningElasticityTypeEnum;  
StructureType: IfcTrackFasteningStructureTypeEnum;  
END\_ENTITY;

**Attribute definitions:**

PreDefinedType: It defines the different types of fastening clips, such as ELASTICRAILFASTENING and RIGIDRAILFASTENING.

StructureType: It defines structural types of fastening components, such as SEPARATEDRAILFASTENING, SEMISEPARATEDRAILFASTENING and NONSEPARATEDRAILFASTENING.

**12.3.6 IfcTrackSleeper**

IfcTrackSleeper is an element to support rails, maintain gauges and transfer the load to the ballast bed or track concrete slab. IfcTrackSleeper, IfcTrackFastening and IfcTrackRail may be composed into IfcTrackPanel.

**Table 12.12 Property sets for IfcTrackSleeper**

PredefinedType	Name
	Pset_TrackSleeperCommon
	Pset_ConcreteElementGeneral
	Pset_PrecastConcreteElementFabrication
	Pset_PrecastConcreteElementGeneral

**Table 12.13 IfcTrackSleeper contained in spatial structure**

Spatial Structure	Description
IfcTrackPart	IfcTrackSleeper should be contained in IfcTrackPart.
IfcTrack	IfcTrackSleeper may be contained in IfcTrack.

**EXPRESS Specification:**

ENTITY IfcTrackSleeper  
SUBTYPE OF (IfcTrackElement);  
PreDefinedType: IfcTrackSleeperTypeEnum;  
END\_ENTITY;

**Attribute definitions:**

PreDefinedType: It defines the different structural types of track sleepers. Such as CONCRETESLEEPER, WOODENSLEEPER, BROADCONCRETESLEEPER, CONCRETELASTICSLEEPER, CAPACITIVESLEEPER, ELECTRICINSULATEDSLEEPER, BIBLOCKSLEEPER, SUPPORTINGBLOCK, etc.

**12.3.7 IfcTrackSlab**

IfcTrackSlab refers to a prefabricated reinforced concrete slab or a pre-stressed reinforced concrete slab, which is a main element of slab track. It transfers the load from rails and fastenings to sub-structures uniformly, and transfers the longitudinal and lateral load of track structures to displacement-stopping structures. IfcTrackSlab shall only appear in ballastless track structures.

**Table 12.14 Property sets for IfcTrackSlab**

PredefinedType	Name
	Pset_TrackSlabCommon
	Pset_ConcreteElementGeneral
	Pset_PrecastConcreteElementFabrication
	Pset_PrecastConcreteElementGeneral

**Table 12.15 IfcTrackSlab contained in spatial structure**

Spatial Structure	Description
IfcTrackPart	IfcTrackSlab should be contained in IfcTrackPart.
IfcTrack	IfcTrackSlab may be contained in IfcTrack.

**EXPRESS Specification:**

ENTITY IfcTrackSlab

SUBTYPE OF (IfcTrackElement);  
 PreDefinedType: IfcTrackSlabTypeEnum;  
 END\_ENTITY;

**Attribute definitions:**

PreDefinedType: It defines whether the track slab is pre-stressed or not and the different pre-stressed types of track slab. Such as NONPRESTRESSEDTRACKSLAB, UNIDIRECTIONALPRESTRESSEDTRACKSLAB and BIDIRECTIONALPRESTRESSEDTRACKSLAB.

**12.3.8 IfcTrackConcreteSlab**

IfcTrackConcreteSlab refers to an integral reinforced concrete layer cast in-situ, in which bi-block sleepers, concrete turnout sleepers or other sleepers are embedded. IfcTrackConcreteSlab shall only appear in ballastless track structures.

**Table 12.16 Property sets for IfcTrackConcreteSlab**

PredefinedType	Name
	Pset_ConcreteElementGeneral

**Table 12.17 IfcTrackConcreteSlab contained in spatial structure**

Spatial Structure	Description
IfcTrackPart	IfcTrackConcreteSlab should be contained in IfcTrackPart.
IfcTrack	IfcTrackConcreteSlab may be contained in IfcTrack.

**EXPRESS Specification:**

ENTITY IfcTrackConcreteSlab  
 SUBTYPE OF (IfcTrackElement);  
 PreDefinedType: IfcTrackConcreteSlabTypeEnum;  
 END\_ENTITY;

**Attribute definitions:**

PreDefinedType.

**12.3.9 IfcTrackIsolationLayer**

IfcTrackIsolationLayer is a structure layer placed on the top surface of track bases. It may implement the damage repair of track superstructure under special circumstances and coordinate temperature deformation. IfcTrackIsolationLayer shall only appear in ballastless track structures.

**Table 12.18 Property sets for IfcTrackIsolationLayer**

PredefinedType	Name
	Pset_TrackIsolationLayerCommon

**Table 12.19 IfcTrackIsolationLayer contained in spatial structure**

Spatial Structure	Description
IfcTrackPart	IfcTrackIsolationLayer should be contained in IfcTrackPart.

IfcTrack	IfcTrackIsolationLayer may be contained in IfcTrack.
----------	--

**EXPRESS Specification:**

ENTITY IfcTrackIsolationLayer  
SUBTYPE OF (IfcTrackElement);  
PreDefinedType: IfcTrackIsolationLayerTypeEnum;  
END\_ENTITY;

**Attribute definitions:**

PreDefinedType.

**12.3.10 IfcTrackElasticCushion**

IfcTrackElasticCushion is a kind of layer set on trough sides of a concrete base, which is used for mitigating the impact of longitudinal and lateral load on track structures. IfcTrackElasticCushion shall only appear in ballastless track structures.

**Table 12.20 Property sets for IfcTrackElasticCushion**

PredefinedType	Name
	Pset_TrackElasticCushionCommon

**Table 12.21 IfcTrackElasticCushion contained in spatial structure**

Spatial Structure	Description
IfcTrackPart	IfcTrackElasticCushion should be contained in IfcTrackPart.
IfcTrack	IfcTrackElasticCushion may be contained in IfcTrack.

**EXPRESS Specification:**

ENTITY IfcTrackElasticCushion  
SUBTYPE OF (IfcTrackElement);  
PreDefinedType: IfcTrackElasticCushionTypeEnum;  
END\_ENTITY;

**Attribute definitions:**

PreDefinedType.

**12.3.11 IfcTrackAdjustmentLayer**

IfcTrackAdjustmentLayer is a concrete layer or a mortar layer cast or paved in-situ to support track slabs or track concrete slabs. IfcTrackAdjustmentLayer shall only appear in ballastless track structures.

**Table 12.22 Property sets for IfcTrackAdjustmentLayer**

PredefinedType	Name
	Pset_TrackAdjustmentlayerCommon

**Table 12.23 IfcTrackAdjustmentLayer contained in spatial structure**

Spatial Structure	Description
IfcTrackPart	IfcTrackAdjustmentLayer should be contained in IfcTrackPart.

IfcTrack	IfcTrackAdjustmentLayer may be contained in IfcTrack.
----------	---

**EXPRESS Specification:**

ENTITY IfcTrackAdjustmentLayer  
SUBTYPE OF (IfcTrackElement);  
PreDefinedType: IfcTrackAdjustmentlayerTypeEnum;  
END\_ENTITY;

**Attribute definitions:**

PreDefinedType.

**12.3.12 IfcTrackBase**

IfcTrackBase is a kind of reinforced foundation cast in-situ to support track slabs or track concrete slabs. IfcTrackBase shall only appear in ballastless track structures.

**Table 12.24 Property sets for IfcTrackBase**

PredefinedType	Name
	Pset_TrackBaseCommon
	Pset_ConcreteElementGeneral

**Table 12.25 IfcTrackBase contained in spatial structure**

Spatial Structure	Description
IfcTrackPart	IfcTrackBase should be contained in IfcTrackPart.
IfcTrack	IfcTrackBase may be contained in IfcTrack.

**EXPRESS Specification:**

ENTITY IfcTrackBase  
SUBTYPE OF (IfcTrackElement);  
PreDefinedType: IfcTrackBaseTypeEnum;  
END\_ENTITY;

**Attribute definitions:**

PreDefinedType.

**12.3.13 IfcTrackTurnout**

IfcTrackTurnout is a facility which transforms one track into two or more tracks.

**Table 12.26 Property sets for IfcTrackTurnout**

PredefinedType	Name
	Pset_TurnoutCommon

**Table 12.27 IfcTrackTurnout contained in spatial structure**

Spatial Structure	Description
IfcTrackPart	IfcTrackTurnout should be contained in all the types of IfcTrackPart except the type of WITHNOTURNOUT.
IfcTrack	IfcTrackTurnout may be contained in IfcTrack.

**EXPRESS Specification:**

ENTITY IfcTrackTurnout  
 SUBTYPE OF (IfcTrackElement);  
 PreDefinedType: IfcTrackTurnoutTypeEnum;  
 END\_ENTITY;

**Attribute definitions:**

PreDefinedType: It defines the different structural types of track turnouts. Such as LEFTHANDTURNOUT, RIGHTHANDTURNOUT, SYMMETRICALTURNOUT, SLIPTOURNOUT, SCISSORSCROSSING and COMBINATIONOFSLIPTURNOUTANDSCISSORSCROSSING, etc.

**12.3.14 IfcTrackBallastLayer**

IfcTrackBallastLayer is a structure layer which comprises different kinds of granular materials with different particle size grading, such as crushed stones, pebbles, sands, slags and so on. It can directly support or fix sleepers, transfer loads and play a role in drainage system, etc. One or more IfcTrackBallastLayer may be composed into an IfcBallastBed. IfcTrackBallastLayer shall only appear in ballasted track structures.

**Table 12.28 Property sets for IfcTrackBallastLayer**

PredefinedType	Name
	Pset_TrackBallastLayerCommon

**Table 12.29 IfcTrackBallastLayer contained in spatial structure**

Spatial Structure	Description
IfcTrackPart	IfcTrackBallastLayer should be contained in IfcTrackPart.
IfcTrack	IfcTrackBallastLayer may be contained in IfcTrack.

**EXPRESS Specification:**

ENTITY IfcTrackBallastLayer  
 SUBTYPE OF (IfcTrackElement);  
 PreDefinedType: IfcTrackBallastLayerTypeEnum;  
 END\_ENTITY;

**Attribute definitions:**

PreDefinedType: It defines the different functional types of ballast layers. Such as TOPBALLAST, SUBBALLAST, SPACEFILLEDBALLAST, etc.

**12.3.15 IfcTrackExpansionJoint**

IfcTrackExpansionJoint is a facility to adjust the expansion of rails.

**Table 12.30 Property sets for IfcTrackExpansionJoint**

PredefinedType	Name
	Pset_TrackExpansionJointCommon

**Table 12.31 IfcTrackExpansionJoint contained in spatial structure**

Spatial Structure	Description
-------------------	-------------



IfcTrackPart	IfcTrackExpansionJoint should be contained in IfcTrackPart.
IfcTrack	IfcTrackExpansionJoint may be contained in IfcTrack.

**EXPRESS Specification:**

ENTITY IfcTrackExpansionJoint  
 SUBTYPE OF (IfcTrackElement);  
 PreDefinedType: IfcTrackExpansionJointTypeEnum;  
 END\_ENTITY;

**Attribute definitions:**

PreDefinedType: It defines the different structural types of expansion joints. Such as SINGLEDIRECTION and BIDIRECTION.

**12.3.16 IfcRailwayAssembly**

IfcRailwayAssembly refers to specific element assemblies in track engineering domain. And it is the superclass of all the element assemblies in track engineering domain.

**EXPRESS Specification:**

ENTITY IfcRailwayAssembly  
 SUPERTYPE OF (ONEOF  
 (IfcBallastBed, IfcTrackPanel))  
 SUBTYPE OF (IfcCivilElementAssembly);  
 END\_ENTITY;

**12.3.17 IfcBallastBed**

IfcBallastBed is a part of track structure to support and fix sleepers, which transfers and distributes its load to the top surface of sub-structures. IfcBallastBed shall only appear in ballasted track structures. One IfcBallastBed may contain one or more IfcTrackBallastLayer.

**Table 12.32 IfcBallastBed contained in spatial structure**

Spatial Structure	Description
IfcTrackPart	IfcBallastBed should be contained in IfcTrackPart.
IfcTrack	IfcBallastBed may be contained in IfcTrack.

**Table 12.33 IfcBallastBed entity composition**

PredefinedType	Contained Entities	Description
	IfcTrackBallastLayer	IfcBallastBed may contain IfcTrackBallastLayer.

**EXPRESS Specification:**

ENTITY IfcBallastBed  
 SUBTYPE OF (IfcRailwayAssembly);  
 PreDefinedType: IfcBallastBedTypeEnum;  
 END\_ENTITY;

**Attribute definitions:**

PreDefinedType.

**12.3.18 IfcTrackPanel**

IfcTrackPanel is an element assembly consisting of (two pieces of) rails, sleepers and fastenings which buckle rails on sleepers. IfcTrackPanel may be comprised of IfcTrackRail, IfcTrackFastening and IfcTrackSleeper.

**Table 12.34 Property sets for IfcTrackPanel**

PredefinedType	Name
	Pset_TrackPanelCommon

**Table 12.35 IfcTrackPanel contained in spatial structure**

Spatial Structure	Description
IfcTrackPart	IfcTrackPanel should be contained in IfcTrackPart.
IfcTrack	IfcTrackPanel may be contained in IfcTrack.

**Table 12.36 IfcTrackPanel entity composition**

PredefinedType	Contained Entities	Description
	IfcTrackRail	IfcTrackPanel may contain IfcTrackRail.
	IfcTrackFastening	IfcTrackPanel may contain IfcTrackFastening.
	IfcTrackSleeper	IfcTrackPanel may contain IfcTrackSleeper.

**EXPRESS Specification:**

```
ENTITY IfcTrackPanel
  SUBTYPE OF (IfcRailwayAssembly);
    PreDefinedType: IfcTrackPanelTypeEnum;
END_ENTITY;
```

**Attribute definitions:**

PreDefinedType.

**12.3.19 IfcTrackElementComponent**

IfcTrackElementComponent refers to specific element components in track engineering domain. And it is the superclass of all the element components in track engineering domain.

**EXPRESS Specification:**

```
ENTITY IfcTrackElementComponent
  SUPERTYPE OF (ONEOF
    (IfcTrackRailJoint, IfcTrackStrengtheningEquipment, IfcTrackAccessoryEquipment))
  SUBTYPE OF (IfcRailwayElementComponent);
END_ENTITY;
```

**12.3.20 IfcTrackRailJoint**

IfcTrackRailJoint is a kind of connecting component, which is used at joints between adjacent rails.

**Table 12.37 Property sets for IfcTrackRailJoint**

PredefinedType	Name
RAILJOINTFASTENING	Pset_RailJointFasteningCommon

COMPROMISINGJOINT	Pset_RailCompromisingJointCommon
INSULATEDJOINT	Pset_RailInsulatedJointCommon
WELDEDJOINT	Pset_RailWeldedJointCommon
CONDUCTIVEJOINT	Pset_RailConductiveJointCommon
UNCHANGABLEJOINT	Pset_RailUnchangeableJointCommon

**Table 12.38 IfcTrackRailJoint contained in spatial structure**

Spatial Structure	Description
IfcTrackPart	IfcTrackRailJoint should be contained in IfcTrackPart.
IfcTrack	IfcTrackRailJoint may be contained in IfcTrack.

**EXPRESS Specification:**

ENTITY IfcTrackRailJoint  
SUBTYPE OF (IfcTrackElementComponent);  
PreDefinedType: IfcTrackRailJointTypeEnum;  
END\_ENTITY;

**Attribute definitions:**

PreDefinedType: It defines the different functional types of rail joints. Such as RAILJOINTFASTENING, COMPROMISINGJOINT, INSULATEDJOINT, WELDEDJOINT, CONDUCTIVEJOINT, UNCHANGEABLEJOINT, etc.

**12.3.21 IfcTrackStrengtheningEquipment**

IfcTrackStrengtheningEquipment is a kind of facility installed on track structures to improve the rail's ability to resist longitudinal and lateral slippage.

**Table 12.39 Property sets for IfcTrackStrengtheningEquipment**

PredefinedType	Name
	Pset_TrackStrengtheningEquipmentCommon

**Table 12.40 IfcTrackStrengtheningEquipment contained in spatial structure**

Spatial Structure	Description
IfcTrackPart	IfcTrackStrengtheningEquipment should be contained in IfcTrackPart.
IfcTrack	IfcTrackStrengtheningEquipment may be contained in IfcTrack.

**EXPRESS Specification:**

ENTITY IfcTrackStrengtheningEquipment  
SUBTYPE OF (IfcTrackElementComponent);  
PreDefinedType: IfcTrackStrengtheningEquipmentTypeEnum;  
END\_ENTITY;

**Attribute definitions:**

PreDefinedType: It defines the different structural types of track strengthening equipment. Such as ANTICREEPER, ANTICREEPSTRUT, GAUGETIEROD, RAILBRACE, etc.

**12.3.22 IfcTrackAccessoryEquipment**

IfcTrackAccessoryEquipment is a kind of facility installed on or nearby track structures, which plays a specific role of sealing, protection, absorption, etc.

**Table 12.41 Property sets for IfcTrackAccessoryEquipment**

PredefinedType	Name
	Pset_TrackAccessoryEquipmentCommon

**Table 12.42 IfcTrackAccessoryEquipment contained in spatial structure**

Spatial Structure	Description
IfcTrackPart	IfcTrackAccessoryEquipment should be contained in IfcTrackPart.
IfcTrack	IfcTrackAccessoryEquipment may be contained in IfcTrack.

**EXPRESS Specification:**

ENTITY IfcTrackAccessoryEquipment  
 SUBTYPE OF (IfcTrackElementComponent);  
 PreDefinedType: IfcTrackAccessoryEquipmentTypeEnum;  
 END\_ENTITY;

**Attribute definitions:**

PreDefinedType: It defines the different functional types of track accessory equipment. Such as SEALINGSTRIPBETWEENSLEEPERS, STEELSPRINGVIBRATIONISOLATOR, RUBBERDAMPINGPAD, SOUNDABSORBINGPANEL, GUARDRAIL, etc.

**12.3.23 IfcEarthingTerminal**

IfcEarthingTerminal refers to a terminal connected to a grounding object.

**Table 12.43 Property sets for IfcEarthingTerminal**

PredefinedType	Name
	Pset_EarthingTerminalCommon

**Table 12.44 IfcEarthingTerminal contained in spatial structure**

Spatial Structure	Description
IfcTrackPart	IfcEarthingTerminal should be contained in IfcTrackPart.
IfcTrack	IfcEarthingTerminal may be contained in IfcTrack.

**EXPRESS Specification:**

ENTITY IfcEarthingTerminal  
 SUBTYPE OF (IfcRailwayElementComponent);  
 PreDefinedType: IfcEarthingTerminalTypeEnum;  
 END\_ENTITY;

**Attribute definitions:**

PreDefinedType:

**12.4 Property Set Definition**

**12.4.1 Pset\_TrackCommon**

Name: Pset\_TrackCommon

Applicable Entities: IfcTrack

Description: Properties common to the definition of all occurrences of IfcTrack.

Property Definitions: See Table 12.45.

**Table 12.45 Property definitions of Pset\_TrackCommon**

Name	Type	Description
ID	TypePropertySingleValue/IfcLabel	The ID of a track.
EffectiveLength	TypePropertySingleValue/IfcNonNegativeLengthMeasure/m	The effective length of a track.
IsOutOfGauge	TypePropertySingleValue/IfcBoolean	Out of Gauge or not. It shows whether an out-of-gauge freight train is permissible on a track or not.
IsElectrified	TypePropertySingleValue/IfcBoolean	Electrified or not. It shows whether a track is an electrified route or not.
IsCWR	TypePropertySingleValue/IfcBoolean	CWR or not. It shows whether a track is a CWR or not.
CWRType	TypePropertyEnumeratedValue/PEnum_ElementCWRType:WITHTEMPERATURESTRESSCWR,AUTODISPERSINGTEMPERATURESTRESSCWR,REGULARDISPERSINGTEMPERATURESTRESSCWR	It shows the type of CWR of a track (It is valid only when IsCWR is TRUE). The enumeration is WITHTEMPERATURESTRESSCWR, AUTODISPERSINGTEMPERATURESTRESSCWR and REGULARDISPERSINGTEMPERATURESTRESSCWR.
LengthOfCWR	TypePropertyEnumeratedValue/PEnum_ElementLengthOfCWR:ORDINARYCWR,CWRWITHINSECTION,CWRWITHWELDEDTURNOUT	The type of long rails of CWR. It shows the long rails type of CWR of a track (It is valid only when IsCWR is TRUE). The enumeration is ORDINARYCWR, CWRWITHINSECTION and CWRWITHWELDEDTURNOUT.

#### 12.4.2 Pset\_TrackPartCommon

Name: Pset\_TrackPartCommon

Applicable Entities: IfcTrackPart

Description: Properties common to the definition of all occurrences of IfcTrackPart.

Property Definitions: See Table 12.46.

**Table 12.46 Property definitions of Pset\_TrackPartCommon**

Name	Type	Description
StructureType	TypePropertySingleValue/IfcLabel	The structural type of a track structure. It shows the structural type of track structure in a track part.
Height	TypePropertySingleValue/IfcNonNegativeLengthMeasure/m	The height of a track structure. For ballasted track, it shows the elevation difference between the top surface of inner rail and the shoulder of its sub-foundations. For ballastless track, it shows the elevation difference between the top surface of inner rail and the top surface of its sub-foundations.
Stress-freeRailTemperature	TypePropertySingleValue/IfcThermodynamicTemperatureMeasure/°C	The temperature of the rail when it is Stress-free.

#### 12.4.3 Pset\_RailCommon

Name: Pset\_RailCommon

Applicable Entities: IfcTrackRail

Description: Properties common to the definition of all occurrences of IfcTrackRail.

Property Definitions: See Table 12.47.

**Table 12.47 Property definitions of IfcTrackRail**

Name	Type	Description
Type	TypePropertyEnumeratedValue/PEnum_ElementType:75N,75kg/m,60N,60kg/m,50kg/m,43kg/m,75-60kg/m,60-50kg/m,50-43kg/m	The type of a rail. The enumeration is 75N, 75kg/m, 60N, 60kg/m, 50kg/m, 43kg/m, 75-60kg/m, 60-50kg/m and 50-43kg/m.
SpecifiedLength	TypePropertyEnumeratedValue/PEnum_ElementSpecifiedLength:100m,75m,25m,12.5m,12.46m,12.42m,12.38m,24.96m,24.92m,24.84m	The specified length of a rail calibrated in the factory. The enumeration is 100m, 75m, 25m, 12.5m, 12.46m, 12.42m, 12.38m, 24.96m, 24.92m and 24.84m.
ChemicalComposition	TypePropertyEnumeratedValue/PEnum_ElementChemicalComposition	The chemical composition of a rail. The enumeration is

	n:CARBONRAILSTEEL,MICROALLOYEDRAILSTEEL,LOWALLOYEDRAILSTEEL	CARBONRAILSTEEL, MICROALLOYEDRAILSTEEL and LOWALLOYEDRAILSTEEL.
DeliveryState	TypePropertyEnumeratedValue/PE num_ElementDeliveryState:HOTROLLING,HEATTREATMENT	The delivery state of a rail. The enumeration is HOTROLLING and HEATTREATMENT.
MinimumTensileStrength	TypePropertySingleValue/IfcPressureMeasure/MPa	The minimum tensile strength of a rail.
SteelGrade	TypePropertyEnumeratedValue/PE num_ElementSteelGrade:U74,U71Mn,U75V,U77MnCr,U76NbRe,U78CrV	The grade of the steel made into a rail. The enumeration is U74, U71Mn, U75V, U77MnCr, U76NbRe and U78CrV.
IsReusable	TypePropertySingleValue/IfcBoolean	Whether a rail is a reusable rail or not.
ProcessingStatusOfTheEnd	TypePropertySingleValue/IfcLabel	The processing status of the ends of a rail. It shows whether there are bolt holes at the ends of a rail and heat treated conditions of the ends of a rail.
TechnicalStandard	TypePropertySingleValue/IfcLabel	The technical standard, requirement or code of a rail. It shows the name of the technical standard, technical requirement and code executed when a rail is produced, processed, manufactured, etc.
MassPerLength	TypePropertySingleValue/IfcMassPerLengthMeasure/(kg/m)	The mass of a rail per unit length.
Length	TypePropertySingleValue/IfcNonNegativeLengthMeasure/m	The design length of a rail.

#### 12.4.4 Pset\_TrackFasteningCommon

Name: Pset\_TrackFasteningCommon

Applicable Entities: IfcTrackFastening

Description: Properties common to the definition of all occurrences of IfcTrackFastening.

Property Definitions: See Table 12.48.

**Table 12.48 Property definitions of IfcTrackFastening**

Name	Type	Description
Type	TypePropertySingleValue/IfcLabel	The type of a fastening.
IsSmallResistanceFastening	TypePropertySingleValue/IfcBoolean	Whether a fastening is a small resistance fastening or not.
StandardDrawingNumber	TypePropertySingleValue/IfcLabel	The index number of the standard drawing applied to a fastening.
TechnicalStandard	TypePropertySingleValue/IfcLabel	The technical standard, requirement or code of a fastening. It shows the name of the technical standard, technical requirement and code executed when a fastening is produced, processed, manufactured, etc.

#### 12.4.5 Pset\_TrackSleeperCommon

Name: Pset\_TrackSleeperCommon

Applicable Entities: IfcTrackSleeper

Description: Properties common to the definition of all occurrences of IfcTrackSleeper.

Property Definitions: See Table 12.49.

**Table 12.49 Property definitions of Pset\_TrackSleeperCommon**

Name	Type	Description
Type	TypePropertySingleValue/IfcLabel	The type of a sleeper.
StandardDrawingNumber	TypePropertySingleValue/IfcLabel	The index number of the standard drawing applied to a sleeper.
TechnicalStandard	TypePropertySingleValue/IfcLabel	The technical standard, requirement or code of a sleeper. It shows the name of the technical standard, technical requirement and code executed when a sleeper is produced, processed, manufactured, etc.

#### 12.4.6 Pset\_TrackSlabCommon



Name: Pset\_TrackSlabCommon

Applicable Entities: IfcTrackSlab

Description: Properties common to the definition of all occurrences of IfcTrackSlab.

Property Definitions: See Table 12.50.

**Table 12.50 Property definitions of Pset\_TrackSlabCommon**

<b>Name</b>	<b>Type</b>	<b>Description</b>
Type	TypePropertySingleValue/IfcLabel	The type of a track slab.
StandardDrawingNumber	TypePropertySingleValue/IfcLabel	The index number of the standard drawing applied to a track slab.
TechnicalStandard	TypePropertySingleValue/IfcLabel	The technical standard, requirement or code of a track slab. It shows the name of the technical standard, technical requirement and code executed when a track slab is produced, processed, manufactured, etc.

#### **12.4.7 Pset\_TrackIsolationLayerCommon**

Name: Pset\_TrackIsolationLayerCommon

Applicable Entities: IfcTrackIsolationLayer

Description: Properties common to the definition of all occurrences of IfcTrackIsolationLayer.

Property Definitions: See Table 12.51.

**Table 12.51 Property definitions of Pset\_TrackIsolationLayerCommon**

<b>Name</b>	<b>Type</b>	<b>Description</b>
StructureComposition	TypePropertySingleValue/IfcLabel	Structural component.
TechnicalStandard	TypePropertySingleValue/IfcLabel	The technical standard, requirement or code of an isolation layer. It shows the name of the technical standard, technical requirement and code executed when an isolation layer is produced, processed, manufactured, etc.

#### **12.4.8 Pset\_TrackElasticCushionCommon**

Name: Pset\_TrackElasticCushionCommon

Applicable Entities: IfcTrackElasticCushion

Description: Properties common to the definition of all occurrences of IfcTrackElasticCushion.

Property Definitions: See Table 12.52.

**Table 12.52 Property definitions of TrackElasticCushionCommon**

Name	Type	Description
StructureComposition	TypePropertySingleValue/IfcLabel	Structural component.
TechnicalStandard	TypePropertySingleValue/IfcLabel	The technical standard, requirement or code of an elastic cushion. It shows the name of the technical standard, technical requirement and code executed when an elastic cushion is produced, processed, manufactured, etc.

#### 12.4.9 Pset\_TrackAdjustmentlayerCommon

Name: Pset\_TrackAdjustmentlayerCommon

Applicable Entities: IfcTrackAdjustmentlayer

Description: Properties common to the definition of all occurrences of IfcTrackAdjustmentlayer.

Property Definitions: See Table 12.53.

**Table 12.53 Property definitions of TrackAdjustmentlayerCommon**

Name	Type	Description
Type	TypePropertySingleValue/IfcLabel	The type of an adjustment layer.
TechnicalStandard	TypePropertySingleValue/IfcLabel	The technical standard, requirement or code of an adjustment layer. It shows the name of the technical standard, technical requirement and code executed when an adjustment layer is produced, processed, manufactured, etc.

#### 12.4.10 Pset\_TrackBaseCommon

Name: Pset\_TrackBaseCommon

Applicable Entities: IfcTrackBase

Description: Properties common to the definition of all occurrences of IfcTrackBase.

Property Definitions: See Table 12.54.

**Table 12.54 Property definitions of Pset\_TrackBaseCommon**

Name	Type	Description
IsSurfaceGalling	TypePropertySingleValue /IfcBoolean	Galling the top surface of a track base or not. It shows whether the surface of a track base shall be galled or not.
SurfaceGallingArea	TypePropertySingleValue/IfcArea Measure/m <sup>2</sup>	The galling area of the top surface of a track base (It is valid only when IsSurfaceGalling is TRUE).

#### 12.4.11 Pset\_TrackBallastLayerCommon

Name: Pset\_TrackBallastLayerCommon

Applicable Entities: IfcTrackBallastLayer

Description: Properties common to the definition of all occurrences of IfcTrackBallastLayer.

Property Definitions: See Table 12.55.

**Table 12.55 Property definitions of Pset\_TrackBallastLayerCommon**

Name	Type	Description
BallastClassification	TypePropertySingleValue/IfcLabel	The classification name of the ballast in a ballast layer.

#### 12.4.12 Pset\_TrackExpansionJointCommon

Name: Pset\_TrackExpansionJointCommon

Applicable Entities: IfcTrackExpansionJoint

Description: Properties common to the definition of all occurrences of IfcTrackExpansionJoint.

Property Definitions: See Table 12.56.

**Table 12.56 Property definitions of Pset\_TrackExpansionJointCommon**

Name	Type	Description
Type	TypePropertySingleValue/ IfcLabel	The type of a rail expansion joint.
StandardDrawing Number	TypePropertySingleValue/ IfcLabel	The index number of the standard drawing applied to a rail expansion joint.
TechnicalStandard	TypePropertySingleValue/ IfcLabel	The technical standard, requirement or code of a rail expansion joint. It shows the name of the technical standard, technical requirement and code executed when a rail

		expansion joint is produced, processed, manufactured, etc.
--	--	--

#### 12.4.13 Pset\_TrackPanelCommon

Name: Pset\_TrackPanelCommon

Applicable Entities: IfcTrackPanel

Description: Properties common to the definition of all occurrences of IfcTrackPanel.

Property Definitions: See Table 12.57.

**Table 12.57 Property definitions of Pset\_TrackPanelCommon**

Name	Type	Description
LayingStandard	TypePropertySingleValue/IfcLabel	The laying standard of a track panel. It shows the number of the sleepers contained in a panel per unit length (kilometer).

#### 12.4.14 Pset\_TurnoutCommon

Name: Pset\_TurnoutCommon

Applicable Entities: IfcTrackTurnout

Description: Properties common to the definition of all occurrences of IfcTrackTurnout.

Property Definitions: See Table 12.58.

**Table 12.58 Property definitions of Pset\_TurnoutCommon**

Name	Type	Description
ReferenceName	TypePropertySingleValue/IfcLabel	The index number of the standard drawing applied to a turnout.
DrawingName	TypePropertySingleValue/IfcLabel	The name of the standard drawing applied to a turnout.
DrawingType	TypePropertySingleValue/IfcLabel	The type of the standard drawing applied to a turnout.
TurnoutNumber	TypePropertySingleValue/IfcLabel	The frog number of a turnout.
Weight	TypePropertySingleValue/IfcInteger/(kg/m)	The type of rails in a turnout suitable to the track.
Note	TypePropertySingleValue/IfcLabel	Notes.
ApplicableScope	TypePropertySingleValue/IfcLabel	The application scope of a turnout.
SleeperReferenceName	TypePropertySingleValue/IfcLabel	The index number of the standard drawing applied to sleepers in a turnout.

SpeedStraight	TypePropertySingle Value/IfcLinear VelocityMeasure/(km/h)	The permissible passing speed of a turnout in the straight direction.
SpeedSide	TypePropertySingle Value/IfcLinear VelocityMeasure/(km/h)	The permissible passing speed of a turnout in the lateral direction.
Angle	TypePropertySingle Value/IfcCompoundPlaneAngleMeasure	The crossing angle ( $\alpha$ ) of the frog of a turnout.
radius	TypePropertySingle Value/IfcPositiveLengthMeasure/mm	The radius of a divert curve (R) of a turnout.
Lq	TypePropertySingle Value/IfcPositiveLengthMeasure/mm	The whole length (LQ) of a turnout.
La	TypePropertySingle Value/IfcPositiveLengthMeasure/mm	The distance (a) from the beginning to the center of a turnout.
Lb	TypePropertySingle Value/IfcPositiveLengthMeasure/mm	The distance (b) from the center to the end of a turnout.
LL	TypePropertySingle Value/IfcPositiveLengthMeasure/mm	The distance (L') from the end to the last turnout sleeper of a turnout.
LLq	TypePropertySingle Value/IfcPositiveLengthMeasure/mm	The distance (q) from the beginning to the switch rail of a turnout.
L0	TypePropertySingle Value/IfcPositiveLengthMeasure/mm	The length (L0) of the switch rail of a turnout.
SwitchRailType	TypePropertySingle Value/IfcLabel	The type of the switch rail of a turnout.
FastenerType	TypePropertySingle Value/IfcLabel	The type of the fastening of a turnout.
Linkagetype	TypePropertyEnumeratedValue / PEnum_ElementLinkagetype :inner Lock,outerLock	The type of the linkage of a turnout. The enumeration is INNERLOCK and OUTERLOCK.
QuenchType	TypePropertySingle Value/IfcLabel	The quenching treatment (heat treatment) type of rails of a turnout.
FrogType	TypePropertySingle Value/IfcLabel	The type of the frog of a turnout.

Space	TypePropertySingleValue/IfcPositiveLengthMeasure/mm	The distance between centerlines of tracks involved in a scissors crossing.
-------	---	---

#### 12.4.15 Pset\_RailJointFasteningCommon

Name: Pset\_RailJointFasteningCommon

Applicable Entities: IfcTrackRailJoint / RAILJOINTFASTENING

Description: Properties common to the definition of all occurrences of IfcTrackRailJoint / RAILJOINTFASTENING.

Property Definitions: See Table 12.59.

**Table 12.59 Property definitions of Pset\_RailJointFasteningCommon**

Name	Type	Description
StructureComposition	TypePropertySingleValue/IfcLabel	Structural component. It shows structural components of an ordinary rail joint fastening, and it mainly includes information about the number and type of the joint bars and its matching bolts and washers.

#### 12.4.16 Pset\_RailCompromisingJointCommon

Name: Pset\_RailCompromisingJointCommon

Applicable Entities: IfcTrackRailJoint / COMPROMISINGJOINT

Description: Properties common to the definition of all occurrences of IfcTrackRailJoint / COMPROMISINGJOINT.

Property Definitions: See Table 12.60.

**Table 12.60 Property definitions of Pset\_RailCompromisingJointCommon**

Name	Type	Description
Type	TypePropertySingleValue/IfcLabel	The type of a compromising rail joint fastening.

#### 12.4.17 Pset\_RailInsulatedJointCommon

Name: Pset\_RailInsulatedJointCommon

Applicable Entities: IfcTrackRailJoint / INSULATEDJOINT

Description: Properties common to the definition of all occurrences of IfcTrackRailJoint / INSULATEDJOINT.

Property Definitions: See Table 12.61.

**Table 12.61 Property definitions of Pset\_RailInsulatedJointCommon**

Name	Type	Description
Type	TypePropertySingleValue/IfcLabel	The type of an insulated rail

		joint fastening.
--	--	------------------

#### 12.4.18 Pset\_RailWeldedJointCommon

Name: Pset\_RailWeldedJointCommon

Applicable Entities: IfcTrackRailJoint / WELDEDJOINT

Description: Properties common to the definition of all occurrences of IfcTrackRailJoint / WELDEDJOINT.

Property Definitions: See Table 12.62.

**Table 12.62 Property definitions of Pset\_RailWeldedJointCommon**

Name	Type	Description
WeldedJointType	TypePropertyEnumeratedValue/PEnum_ElementWeldedJointType:FACTORYWELDEDJOINT,UNOINWELDEDJOINT,RAILLINKWELDEDJOINT	The type of a welded rail joint. The enumeration is FACTORYWELDEDJOINT, UNOINWELDEDJOINT and RAILLINKWELDEDJOINT.
WeldedType	TypePropertyEnumeratedValue/PEnum_ElementWeldedType:FIELDWELDING,BASEWELDING,FACTORYWELDING	The welded type of a welded rail joint. The enumeration is FIELDWELDING, BASEWELDING and FACTORYWELDING.
WeldedMethod	TypePropertyEnumeratedValue/PEnum_ElementWeldedMethod:FLASHWELDING,EXOTHERMICWELDING	The welded method of a welded rail joint. The enumeration is FLASHWELDING and EXOTHERMICWELDING.

#### 12.4.19 Pset\_RailConductiveJointCommon

Name: Pset\_RailConductiveJointCommon

Applicable Entities: IfcTrackRailJoint / CONDUCTIVEJOINT

Description: Properties common to the definition of all occurrences of IfcTrackRailJoint / CONDUCTIVEJOINT.

Property Definitions: See Table 12.63.

**Table 12.63 Property definitions of Pset\_RailConductiveJointCommon**

Name	Type	Description
StructureComposition	TypePropertySingleValue/IfcLabel	Structural component. It mainly includes information about the number and type of the joint bars and its matching bolts

		and washers.
--	--	--------------

#### 12.4.20 Pset\_RailUnchangeableJointCommon

Name: Pset\_RailUnchangeableJointCommon

Applicable Entities: IfcTrackRailJoint / UNCHANGEABLEJOINT

Description: Properties common to the definition of all occurrences of IfcTrackRailJoint / UNCHANGEABLEJOINT.

Property Definitions: See Table 12.64.

**Table 12.64 Property definitions of Pset\_RailUnchangeableJointCommon**

Name	Type	Description
StructureComposition	TypePropertySingleValue/IfcLabel	Structural component. It mainly includes information about the number and type of the joint bars and its matching bolts and washers.

#### 12.4.21 Pset\_TrackStrengtheningEquipmentCommon

Name: Pset\_TrackStrengtheningEquipmentCommon

Applicable Entities: IfcTrackStrengtheningEquipment

Description: Properties common to the definition of all occurrences of IfcTrackStrengtheningEquipment.

Property Definitions: See Table 12.65.

**Table 12.65 Property definitions of IfcTrackStrengtheningEquipment**

Name	Type	Description
Type	TypePropertySingleValue/IfcLabel	The type of a track strengthening equipment.
StandardDrawingNumber	TypePropertySingleValue/IfcLabel	The index number of the standard drawing applied to a track strengthening equipment.
TechnicalStandard	TypePropertySingleValue/IfcLabel	The technical standard, requirement or code of a track strengthening equipment. It shows the name of the technical standard, technical requirement and code executed when a track



		strengthening equipment is produced, processed, manufactured, etc.
--	--	--

#### 12.4.22 Pset\_TrackAccessoryEquipmentCommon

Name: Pset\_TrackAccessoryEquipmentCommon

Applicable Entities: IfcTrackAccessoryEquipment

Description: Properties common to the definition of all occurrences of IfcTrackAccessoryEquipment.

Property Definitions: See Table 12.66.

**Table 12.66 Property definitions of Pset\_TrackAccessoryEquipmentCommon**

Name	Type	Description
Type	TypePropertySingleValue/IfcLabel	The type of a track accessory equipment.
StandardDrawingNumber	TypePropertySingleValue/IfcLabel	The index number of the standard drawing applied to a track accessory equipment.
TechnicalStandard	TypePropertySingleValue/IfcLabel	The technical standard, requirement or code of a rail. It shows the name of the technical standard, technical requirement and code executed when a track accessory equipment is produced, processed, manufactured, etc.

#### 12.4.23 Pset\_EarthingTerminalCommon

Name: Pset\_EarthingTerminalCommon

Applicable Entities: IfcEarthingTerminal

Description: Properties common to the definition of all occurrences of IfcEarthingTerminal.

Property Definitions: See Table 12.67.

**Table 12.67 Property definitions of Pset\_EarthingTerminalCommon**

Name	Type	Description
Type	TypePropertySingleValue/IfcLabel	The type of an earthing terminal.
StructureComposition	TypePropertySingleValue/IfcLabel	Structural component.

### 13. Station Schema

#### 13.1 Schema Definition

This schema defines the structure of railway terminal, railway station and their components. The objects in this schema is composed of spatial structure elements and physical elements.

The spatial structure elements of the station schema include IfcRailwayTerminal, IfcRailwayStation and IfcRailwayPlatform.

The physical elements of the station schema include IfcRailwaySignalDevice, IfcRailwaySpeedControlDevice, IfcRailwayDenoterDevice, IfcRailwaySafetyDevice, IfcRailwayMechanicalEquipment, IfcRailwayPlatformWall and IfcRailwayFlatAisle.

Figure 13.1 shows the relationship of all the classes in the station schema.

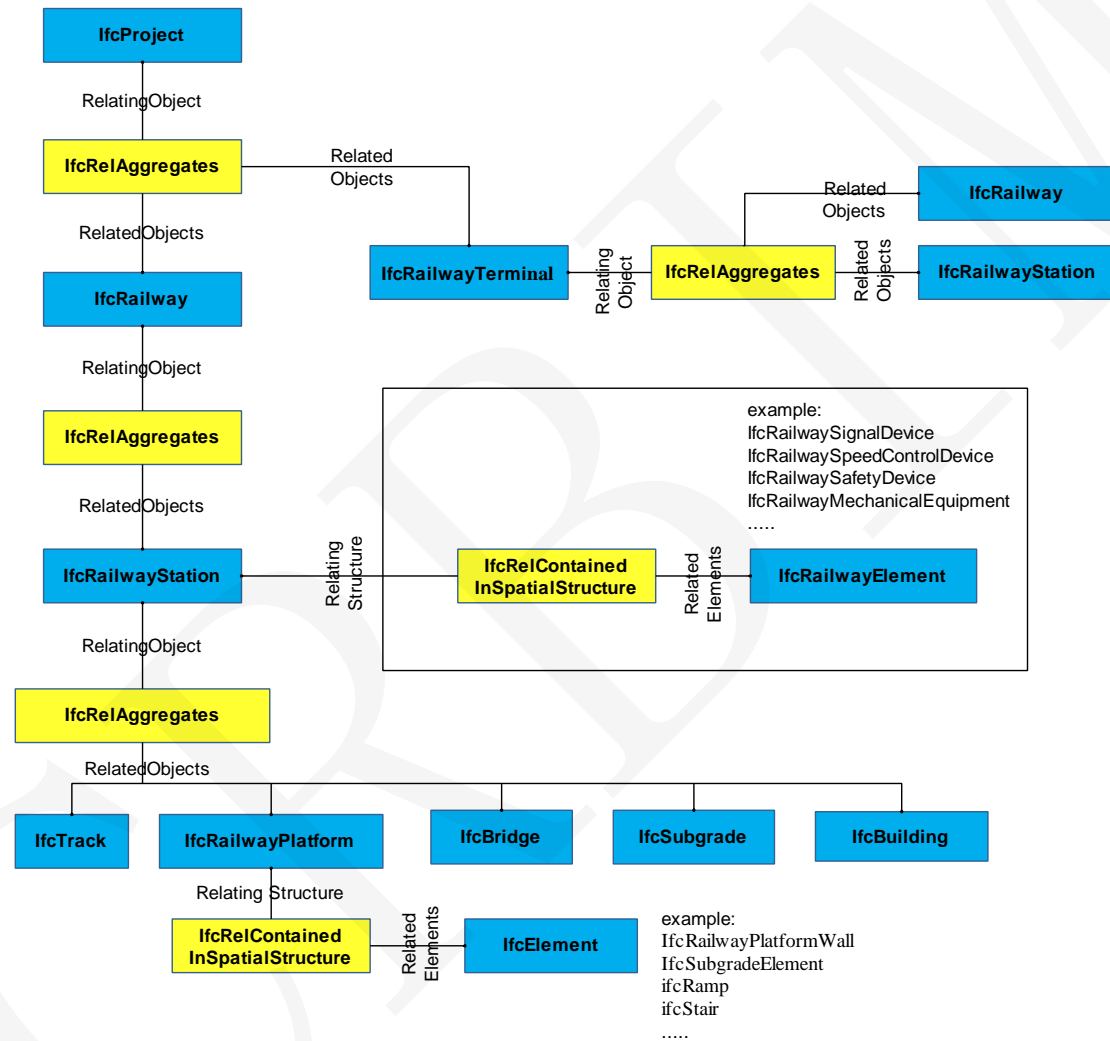

**Figure 13.1 Relationships of all the classes in the station schema**

### 13.1.1 Spatial Structure Elements of Station

The spatial structure elements of railway station represent the spatial objects and its components, including IfcRailwayTerminal, IfcRailwayStation and IfcRailwayStation. Figure 13.2 shows the relationship of all spatial structure elements in the station schema.

IfcRailwayTerminal is derived from IfcRailwayStructureElement. It represents the spatial structure composed of one or several railway stations (IfcRailwayStation) and railways (IfcRailway).

IfcRailwayStation is derived from IfcRailwayStructureElement. It represents a railway station that can implement passenger and freight transportation and other technical operation. It includes several railway elements such as IfcRailwaySignalDevice, IfcRailwayDenoterDevice, IfcRailwaySafetyDevice, IfcRailwayMechanicalEquipment and IfcBuildingElement. In addition, it can also be decomposed into IfcTrack, IfcSubgrade, IfcBridge, IfcRailwayPlatform, IfcBuilding, and IfcRoad by the aggregation relationship IfcRelAggregates.

IfcRailwayPlatform is derived from IfcRailwayStructureElement. It represents a platform including several railway and building elements such as IfcRailwayPlatformWall, IfcRamp and IfcStair.

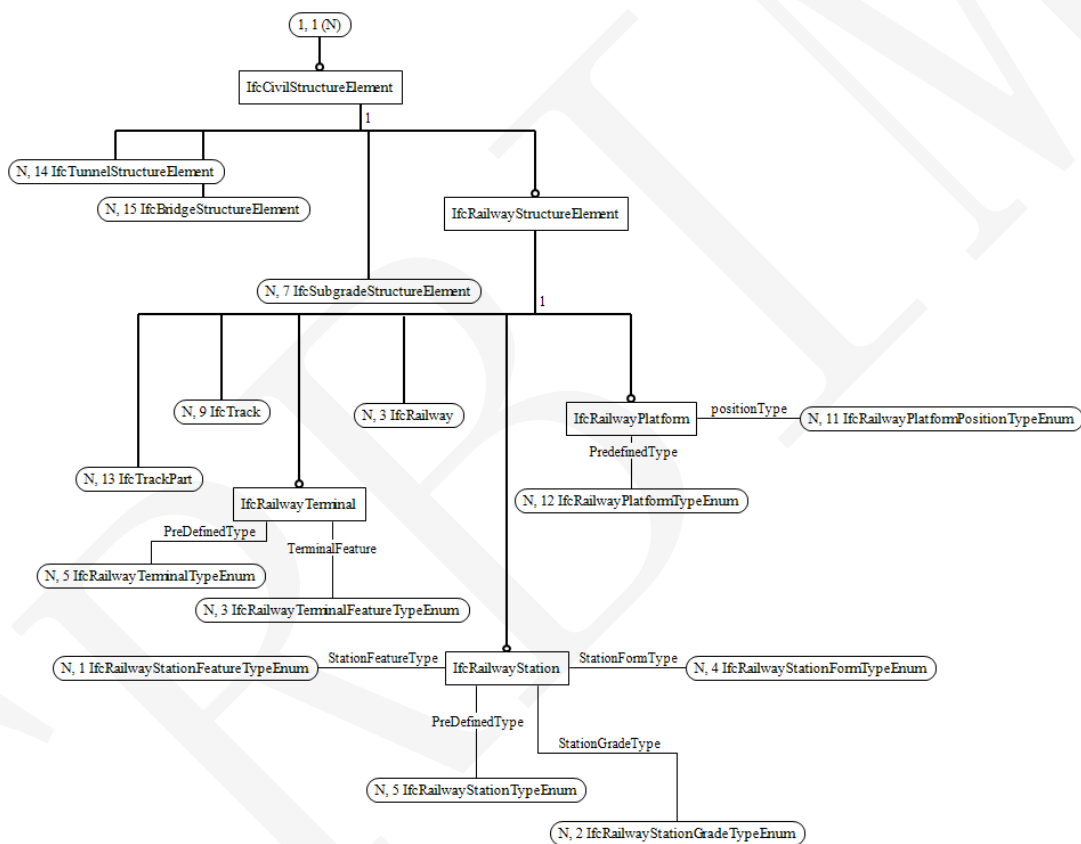

**Figure 13.2 EXPRESS-G diagram for spatial structure elements in station schema**

### 13.1.2 Physical Elements in Station Schema

The elements of railway station refer to the physical elements contained in railway station. They are derived from IfcRailwayElement, including IfcRailwaySignalDevice, IfcRailwaySpeedControlDevice, IfcRailwayFlatAisle, IfcRailwayDenoterDevice, IfcRailwaySafetyDevice, IfcRailwayMechanicalEquipment and IfcRailwayPlatformWall.

IfcRailwaySignalDevice represents the signal devices used in railway station. It has two subtypes named IfcRailwaySignal and IfcRailwayClearancePost.

IfcRailwaySpeedControlDevice represents the facilities to control the speed of train in station yard or throat of yard. It has two subtypes named IfcRailwaySpeedReducer and

IfcRailwaySpeedReducer.

IfcRailwayDenoterDevice represents the facilities to show some information, usually placed in station yards or near railway lines.

IfcRailwaySafetyDevice represents the facilities to ensure the safe train operation. It has four subtypes named IfcRailwayCarBumper, IfcRailwayCarStopper, IfcRailwayIronShoe and IfcRailwayStopRetarder.

IfcRailwayMechanicalEquipment represents the mechanical equipment used in freight transportation. It currently includes three subtypes named IfcWagonScale, IfcTruckScale, and IfcDeflectionInstrument.

IfcRailwayPlatformWall represents the facilities to retain the earthwork in platform.

IfcRailwayFlatAisle represents the facilities placed for people or vehicle to cross railway tracks.

Figure 13.3 shows the inheritance relationship of all elements in station schema.

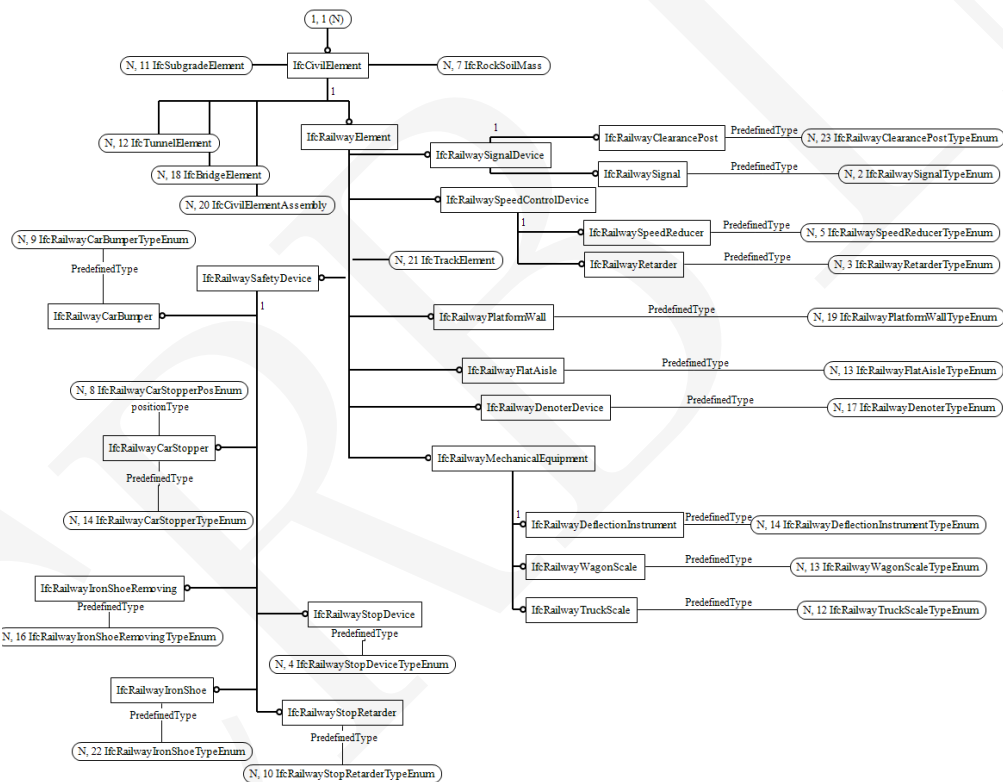

Figure 13.3 EXPRESS-G diagram for elements in station schema

## 13.2 Type Definition

### 13.2.1 IfcRailwayTerminalTypeEnum

This enumeration defines the different types of railway terminals from the perspective of the terminal's form.

#### Enumerated Item Definitions:

ONESTATIONTERMINAL;

```
TRIANGLETERMINAL;  
LINEARTERMINAL;  
CROSSTERMINAL;  
PARALLELTERMINAL;  
RINGLIKETERMINAL;  
MAKEENDTERMINAL;  
COMBINEDTERMINAL;  
USERDEFINED;  
NOTDEFINED.
```

**EXPRESS Specification:**

```
TYPE IfcRailwayTerminalTypeEnum = ENUMERATION OF  
(ONESTATIONTERMINAL  
,TRIANGLETERMINAL  
,LINEARTERMINAL  
,CROSSTERMINAL  
,PARALLELTERMINAL  
,RINGLIKETERMINAL  
,MAKEENDTERMINAL  
,COMBINEDTERMINAL  
,USERDEFINED  
,NOTDEFINED  
);  
END_TYPE;
```

### 13.2.2 IfcRailwayTerminalFeatureTypeEnum

This enumeration defines the different types of railway terminals from the perspective of the terminal's function.

**Enumerated Item Definitions:**

```
NETWORKTERMINAL;  
REGIONALTERMINAL;  
LOCALTERMINAL;  
USERDEFINED;  
NOTDEFINED.
```

**EXPRESS Specification:**

```
TYPE IfcRailwayTerminalFeatureTypeEnum = ENUMERATION OF  
(NETWORKTERMINAL  
,REGIONALTERMINAL  
,LOCALTERMINAL
```

```
,USERDEFINED  
,NOTDEFINED  
);  
END_TYPE;
```

### 13.2.3 IfcRailwayStationTypeEnum

IfcRailwayStationTypeEnum defines the different types of railway stations from the perspective of the station's technical operation.

#### Enumerated Item Definitions:

```
INTERMEDIATESTATION;  
DISTRICTSTATION;  
MARSHALLINGSTATION;  
PASSINGSTATION;  
OVERTAKINGSTATION;  
HALTSTATION: Halt station.  
BLOCKPOST;  
USERDEFINED;  
NOTDEFINED.
```

#### EXPRESS Specification:

```
TYPE IfcRailwayStationTypeEnum = ENUMERATION OF  
(INTERMEDIATESTATION  
,DISTRICTSTATION  
,MARSHALLINGSTATION  
,PASSINGSTATION  
,OVERTAKINGSTATION  
,HALTSTATION  
,BLOCKPOST  
,USERDEFINED  
,NOTDEFINED  
);  
END_TYPE;
```

### 13.2.4 IfcRailwayStationFeatureTypeEnum

IfcRailwayStationFeatureTypeEnum defines the different types of railway stations from the perspective of the station's function.

#### Enumerated Item Definitions:

```
PASSENGERSTATION;  
FREIGHTSTATION;  
PASSENGERANDFREIGHTSTATION;  
USERDEFINED;
```

NOTDEFINED.

**EXPRESS Specification:**

```
TYPE IfcRailwayStationFeatureTypeEnum = ENUMERATION OF  
(PASSENGERSTATION  
,FREIGHTSTATION  
,PASSENGERANDFREIGHTSTATION  
,USERDEFINED  
,NOTDEFINED  
);  
END_TYPE;
```

**13.2.5 IfcRailwayStationFormTypeEnum**

IfcRailwayStationFormTypeEnum defines the different types of railway stations from the perspective of the station's form.

**Enumerated Item Definitions:**

```
TRANSVERSEARRANGEMENT;  
LONGITUDINALARRANGMENT;  
MIXEDARRANGMENT;  
USERDEFINED;  
NOTDEFINED.
```

**EXPRESS Specification:**

```
TYPE IfcRailwayStationFormTypeEnum = ENUMERATION OF  
(TRANSVERSEARRANGEMENT  
,LONGITUDINALARRANGMENT  
,MIXEDARRANGMENT  
,USERDEFINED  
,NOTDEFINED  
);  
END_TYPE;
```

**13.2.6 IfcRailwayStationGradeTypeEnum**

IfcRailwayStationGradeTypeEnum defines the different types of railway stations from the perspective of the station's grade.

**Enumerated Item Definitions:**

```
GRADESUPER;  
GRADEFIRST;  
GRADESECOND;  
GRADETHIRD;  
GRADEFOURTH;
```

GRADEFIFTH;  
USERDEFINED;  
NOTDEFINED.

**EXPRESS Specification:**

```
TYPE IfcRailwayStationGradeTypeEnum = ENUMERATION OF  
(GRADESUPER  
,GRADEFIRST  
,GRADESECOND  
,GRADETHIRD  
,GRADEFOURTH  
,GRADEFIFTH  
,USERDEFINED  
,NOTDEFINED  
);  
END_TYPE;
```

**13.2.7 IfcRailwayPlatformTypeEnum**

IfcRailwayPlatformTypeEnum defines the different types of station platforms from the perspective of the platform's function.

**Enumerated Item Definitions:**

PASSENGERPLATFORM;  
FREIGHTPLATFORM;  
USERDEFINED;  
NOTDEFINED.

**EXPRESS Specification:**

```
TYPE IfcRailwayPlatformTypeEnum = ENUMERATION OF  
(PASSENGERPLATFORM  
,FREIGHTPLATFORM  
,USERDEFINED  
,NOTDEFINED  
);  
END_TYPE;
```

**13.2.8 IfcRailwayPlatformPositionTypeEnum**

IfcRailwayPlatformPositionTypeEnum defines the different types of station platforms from the perspective of the platform's position.

**Enumerated Item Definitions:**

INTERMEDIATEPLATFORM;  
BASICPLATFORM;  
ENDTYPEPLATFORM;



USERDEFINED;  
NOTDEFINED.

**EXPRESS Specification:**

```
TYPE IfcRailwayPlatformPositionTypeEnum = ENUMERATION OF  
  (INTERMEDIATEPLATFORM  
  ,BASICPLATFORM  
  ,ENDTYPEPLATFORM  
  ,USERDEFINED  
  ,NOTDEFINED  
  );  
END_TYPE;
```

**13.2.9 IfcRailwaySignalTypeEnum**

IfcRailwaySignalTypeEnum defines the different types of signals from the perspective of the signal's function.

**Enumerated Item Definitions:**

STARTINGSIGNAL;  
HOMESIGNAL;  
ROUTESIGNAL;  
SHUNTINGSIGNAL;  
HUMPSIGNAL;  
BLOCKSIGNAL;  
DISTANTSIGNAL;  
APPROACHSIGNAL;  
REPEATINGSIGNAL;  
USERDEFINED;  
NOTDEFINED.

**EXPRESS Specification:**

```
TYPE IfcRailwaySignalTypeEnum = ENUMERATION OF  
  (STARTINGSIGNAL  
  ,HOMESIGNAL  
  ,ROUTESIGNAL  
  ,SHUNTINGSIGNAL  
  ,HUMPSIGNAL  
  ,BLOCKSIGNAL  
  ,DISTANTSIGNAL  
  ,APPROACHSIGNAL  
  ,REPEATINGSIGNAL  
  ,USERDEFINED
```

```
    ,NOTDEFINED
);
END_TYPE;
```

### 13.2.10 IfcRailwayClearancePostTypeEnum

IfcRailwayClearancePostTypeEnum defines the different types of clearance posts from the perspective of the clearance post's function.

#### Enumerated Item Definitions:

```
USERDEFINED;
NOTDEFINED.
```

#### EXPRESS Specification:

```
TYPE IfcRailwayClearancePostTypeEnum = ENUMERATION OF
    (USERDEFINED
    ,NOTDEFINED
);
END_TYPE;
```

### 13.2.11 IfcRailwaySpeedReducerTypeEnum

IfcRailwaySpeedReducerTypeEnum defines the different types of speed reducers from the perspective of the speed reducer's operation type.

#### Enumerated Item Definitions:

```
WINDPRESSURECLAMP;
WINDPRESSUREGRAVITY;
USERDEFINED;
NOTDEFINED.
```

#### EXPRESS Specification:

```
TYPE IfcRailwaySpeedReducerTypeEnum = ENUMERATION OF
    (WINDPRESSURECLAMP
    ,WINDPRESSUREGRAVITY
    ,USERDEFINED
    ,NOTDEFINED
);
END_TYPE;
```

### 13.2.12 IfcRailwayRetarderTypeEnum

IfcRailwayRetarderTypeEnum defines the different types of railway retarders from the perspective of the railway retarder's operation type.

#### Enumerated Item Definitions:

```
COMMONRETARDER;
CONTROLLABLEDRETARDER;
```

USERDEFINED;  
NOTDEFINED.

**EXPRESS Specification:**

```
TYPE IfcRailwayRetarderTypeEnum = ENUMERATION OF  
    (COMMONRETARDER  
    ,CONTROLLABLEDRETARDER  
    ,USERDEFINED  
    ,NOTDEFINED  
);  
END_TYPE;
```

**13.2.13 IfcRailwayDenoterTypeEnum**

IfcRailwayDenoterTypeEnum defines the different types of denoters from the perspective of the denoter's function.

**Enumerated Item Definitions:**

BOUNDARYSIGN;  
PARKINGSIGN;  
SAFETYSIGN;  
LANDMARKSIGN;  
CROSSINGALERTSIGN;  
ROUTESIGN;  
SIGNALSIGN;  
DISPLACEMENTOBSERVATIONPEG;  
USERDEFINED;  
NOTDEFINED.

**EXPRESS Specification:**

```
TYPE IfcRailwayDenoterTypeEnum = ENUMERATION OF  
    (BOUNDARYSIGN  
    ,PARKINGSIGN  
    ,SAFETYSIGN  
    ,LANDMARKSIGN  
    ,CROSSINGALERTSIGN  
    ,ROUTESIGN  
    ,SIGNALSIGN  
    ,DISPLACEMENTOBSERVATIONPEG  
    ,USERDEFINED  
    ,NOTDEFINED  
);  
END_TYPE;
```

### 13.2.14 IfcRailwayCarBumperTypeEnum

IfcRailwayCarBumperTypeEnum defines the different types of car bumpers from the perspective of the car bumper's pattern.

#### Enumerated Item Definitions:

MOUNDTYPE;  
MORTARRUBBLETYPE;  
CURVEDTYPEA;  
CURVEDTYPEB;  
USERDEFINED;  
NOTDEFINED.

#### EXPRESS Specification:

```
TYPE IfcRailwayCarBumperTypeEnum = ENUMERATION OF
  (MOUNDTYPE
  ,MORTARRUBBLETYPE
  ,CURVEDTYPEA
  ,CURVEDTYPEB
  ,USERDEFINED
  ,NOTDEFINED
);
END_TYPE;
```

### 13.2.15 IfcRailwayCarStopperTypeEnum

IfcRailwayCarStopperTypeEnum defines the different types of car stoppers from the perspective of the car stopper's pattern.

#### Enumerated Item Definitions:

FIXEDSTOPPER;  
SLIDESTOPPER;  
USERDEFINED;  
NOTDEFINED.

#### EXPRESS Specification:

```
TYPE IfcRailwayCarStopperTypeEnum = ENUMERATION OF
  (FIXEDSTOPPER
  ,SLIDESTOPPER
  ,USERDEFINED
  ,NOTDEFINED
);
END_TYPE;
```

### 13.2.16 IfcRailwayCarStopperPostionTypeEnum

IfcRailwayCarStopperPostionTypeEnum defines the different types of car stoppers from the perspective of the car stopper's position.

**Enumerated Item Definitions:**

INSIDETYPE;  
OUTSIDETYPE;  
USERDEFINED;  
NOTDEFINED.

**EXPRESS Specification:**

```
TYPE IfcRailwayCarStopperPostionTypeEnum = ENUMERATION OF  
    (INSIDETYPE  
    ,OUTSIDETYPE  
    ,NOTDEFINED  
    ,USERDEFINED  
);  
END_TYPE;
```

### 13.2.17 IfcRailwayPlatformWallTypeEnum

IfcRailwayPlatformWallTypeEnum defines the different types of platform walls from the perspective of the platform wall's pattern.

**Enumerated Item Definitions:**

STRAIGHTWALL;  
INCLINEDWALL;  
USERDEFINED;  
NOTDEFINED.

**EXPRESS Specification:**

```
TYPE IfcRailwayPlatformWallTypeEnum = ENUMERATION OF  
    (STRAIGHTWALL  
    ,INCLINEDWALL  
    ,USERDEFINED  
    ,NOTDEFINED  
);  
END_TYPE;
```

### 13.2.18 IfcRailwayFlatAisleTypeEnum

IfcRailwayFlatAisleTypeEnum defines the different types of flat aisles from the perspective of the flat aisle's function.

**Enumerated Item Definitions:**

USERDEFINED;  
NOTDEFINED.

**EXPRESS Specification:**

```
TYPE IfcRailwayFlatAisleTypeEnum = ENUMERATION OF
  (USERDEFINED
  ,NOTDEFINED
  );
END_TYPE;
```

**13.2.19 IfcRailwayWagonScaleTypeEnum**

IfcRailwayWagonScaleTypeEnum defines the different types of wagon scales from the perspective of the wagon scale's function.

**Enumerated Item Definitions:**

```
USERDEFINED;
NOTDEFINED.
```

**EXPRESS Specification:**

```
TYPE IfcRailwayWagonScaleTypeEnum = ENUMERATION OF
  (USERDEFINED
  ,NOTDEFINED
  );
END_TYPE;
```

**13.2.20 IfcRailwayDeflectionInstrumentTypeEnum**

IfcRailwayDeflectionInstrumentTypeEnum defines the different types of deflection instruments from the perspective of the deflection instrument's function.

**Enumerated Item Definitions:**

```
USERDEFINED;
NOTDEFINED.
```

**EXPRESS Specification:**

```
TYPE IfcRailwayDeflectionInstrumentTypeEnum = ENUMERATION OF
  (USERDEFINED
  ,NOTDEFINED
  );
END_TYPE;
```

**13.2.21 IfcRailwayIronShoeRemovingTypeEnum**

IfcRailwayIronShoeRemovingTypeEnum defines the type of Iron Shoe Removing from the perspective of the Iron Shoe Removing's function.

**Enumerated Item Definitions:**

```
USERDEFINED;
NOTDEFINED.
```

**EXPRESS Specification:**

```
TYPE IfcRailwayIronShoeRemovingTypeEnum = ENUMERATION OF
  (USERDEFINED
  ,NOTDEFINED
  );
END_TYPE;
```

**13.2.22 IfcRailwayStopDeviceTypeEnum**

IfcRailwayStopDeviceTypeEnum defines the type of railway stop device from the perspective of the railway stop device's function.

**Enumerated Item Definitions:**

```
USERDEFINED;
NOTDEFINED.
```

**EXPRESS Specification:**

```
TYPE IfcRailwayStopDeviceTypeEnum = ENUMERATION OF
  (USERDEFINED
  ,NOTDEFINED
  );
END_TYPE;
```

**13.2.23 IfcRailwayStopRetarderTypeEnum**

IfcRailwayStopRetarderTypeEnum defines the type of railway stop retarder from the perspective of function.

**Enumerated Item Definitions:**

```
USERDEFINED;
NOTDEFINED.
```

**EXPRESS Specification:**

```
TYPE IfcRailwayStopRetarderTypeEnum = ENUMERATION OF
  (USERDEFINED
  ,NOTDEFINED
  );
END_TYPE;
```

**13.2.24 IfcRailwayIronShoeTypeEnum**

IfcRailwayIronShoeTypeEnum defines the type of railway iron shoes from the perspective of the function.

**Enumerated Item Definitions:**

```
USERDEFINED;
NOTDEFINED.
```

**EXPRESS Specification:**

```

TYPE IfcRailwayIronShoeTypeEnum = ENUMERATION OF
    (USERDEFINED
    ,NOTDEFINED
    );
END_TYPE;

```

**13.3 Entity Definition****13.3.1 IfcRailwayTerminal**

IfcRailwayTerminal defines the spatial structure that is composed of several stations, facilities and railway lines serving railway transportation.

**Table 13.1 IfcRailwayTerminal spatial decomposition**

Spatial Parts	Description
IfcRailwayStation	Spatial decomposition into railway stations.
IfcRailway	Spatial decomposition into railway lines.

**EXPRESS Specification:**

```

ENTITY IfcRailwayTerminal
    SUBTYPE OF (IfcRailwayStructureElement);
    PreDefinedType: IfcRailwayTerminalTypeEnum;
    TerminalFeature: IfcRailwayTerminalFeatureTypeEnum;
END_ENTITY;

```

**Attribute definitions:**

PreDefinedType: Predefined types of IfcRailwayTerminal.

TerminalFeature: Functional types of IfcRailwayTerminal.

**13.3.2 IfcRailwayStation**

IfcRailwayStation defines a railway station.

**Table 13.2 IfcRailwayStation spatial composition**

Spatial Composite	Description
IfcRailway	Direct assignment to railway, if Railway Station is the outermost spatial container, and no terminal information is provided for station.
IfcRailwayTerminal	Assignment to Railway Terminal, if Railway Station is the spatial container for railway with terminal information.

**Table 13.3 IfcRailwayStation spatial decomposition**

Spatial Parts	Description
IfcCivilStructureElement	Spatial decomposition into other civil structure elements, e.g. IfcTrack, IfcBridge, IfcSubgrade, IfcRailwayPlatform.
IfcBuilding	Spatial decomposition into several buildings.



**Table 13.4 IfcRailwayStation spatial containment**

Contained Entities	Description
IfcCivilElement	Physical civil elements contained in the station, e.g. IfcRailwaySignalDevice, IfcRailwaySpeedControlDevice, IfcRailwayDenoterDevice, IfcRailwaySafetyDevice, IfcRailwayMechanicalEquipment, IfcRailwayFlatAisle.
IfcBuildingElement	Building elements can also be contained in the station.

**Table 13.5 Property sets for IfcRailwayStation**

PredefinedType	Name
	Pset_StationCommon

**EXPRESS Specification:**

ENTITY IfcRailwayStation

SUBTYPE OF (IfcRailwayStructureElement);

PreDefinedType: IfcRailwayStationTypeEnum;

StationFeatureType: IfcRailwayStationFeatureTypeEnum;

StationGradeType: IfcRailwayStationGradeTypeEnum;

StationFormType: IfcRailwayStationFormTypeEnum;

END\_ENTITY;

**Attribute definitions:**

PreDefinedType: Predefined types of IfcRailwayStation

StationFeatureType: functional types of IfcRailwayStation

StationGradeType: Grade types of IfcRailwayStation

StationFormType: Form types of IfcRailwayStation

**13.3.3 IfcRailwayPlatform**

IfcRailwayPlatform represents a platform which can implement passenger and freight transportation.

**Table 13.6 IfcRailwayPlatform spatial composition**

Spatial Composite	Description
IfcRailwayStation	Assignment to railway station.

**Table 13.7 IfcRailwayPlatform spatial containment**

Contained Entities	Description
IfcElement	Building elements and civil elements can be contained in a railway platform, such as IfcRailwayPlatformWall, IfcSubgradeElement, IfcRamp, IfcStair, etc.

**EXPRESS SPECIFICATION:**

ENTITY IfcRailwayPlatform

SUBTYPE OF (IfcRailwayStructureElement);

PredefinedType: IfcRailwayPlatformTypeEnum;  
 PositionType: IfcRailwayPlatformPositionTypeEnum;  
 END\_ENTITY;

**Attribute definitions:**

PreDefinedType: Predefined types of IfcRailwayPlatform.

PositionType: Location types of IfcRailwayPlatform.

**13.3.4 IfcRailwaySignalDevice**

IfcRailwaySignalDevice defines the facilities which can control the train operation.

**Table 13.8 IfcRailwaySignalDevice contained in spatial structure**

Spatial Structure	Description
IfcRailwayStation	IfcRailwaySignalDevice can be contained in a railway station.
IfcRailway	Directly contained in railway, if the signal device has no station information.

**EXPRESS Specification:**

ENTITY IfcRailwaySignalDevice  
 SUPERTYPE OF (ONEOF (IfcRailwaySignal, IfcRailwayClearancePost))  
 SUBTYPE OF (IfcRailwayElement);  
 END\_ENTITY;

**13.3.5 IfcRailwaySignal**

IfcRailwaySignal defines the control facility with colorful lamp to control the train operation by unified management.

**Table 13.9 Property sets for IfcRailwaySignal**

PredefinedType	Name
	Pset_SignalCommon

**EXPRESS Specification:**

ENTITY IfcRailwaySignal  
 SUBTYPE OF (IfcRailwaySignalDevice);  
 PredefinedType: IfcRailwaySignalTypeEnum;  
 END\_ENTITY;

**Attribute definitions:**

PreDefinedType: Predefined types of IfcRailwaySignal.

**13.3.6 IfcRailwayClearancePost**

IfcRailwayClearancePost defines the facility to alert limited position for train parking.

**EXPRESS Specification:**

ENTITY IfcRailwayClearancePost  
 SUBTYPE OF (IfcRailwaySignalDevice);  
 PredefinedType: IfcRailwayClearancePostTypeEnum;  
 END\_ENTITY;

**Attribute definitions:**

PreDefinedType: Predefined types of IfcRailwayClearancePost.

### 13.3.7 IfcRailwaySpeedControlDevice

IfcRailwaySpeedControlDevice defines the facility to adjust the speed of the train.

**Table 13.10 IfcRailwaySpeedControlDevice contained in spatial structure**

Spatial Structure	Description
IfcRailwayStation	IfcRailwaySpeedControlDevice is contained in the railway station.

**EXPRESS Specification:**

ENTITY IfcRailwaySpeedControlDevice  
SUPERTYPE OF (ONEOF (IfcRailwaySpeedReducer, IfcRailwayRetarder))  
SUBTYPE OF (IfcRailwayElement);  
END\_ENTITY;

### 13.3.8 IfcRailwaySpeedReducer

IfcRailwaySpeedReducer defines the facility placed in the classification yard or the head of hump to control the speed of the train.

**EXPRESS Specification:**

ENTITY IfcRailwaySpeedReducer  
SUBTYPE OF (IfcRailwaySpeedControlDevice);  
PredefinedType: IfcRailwaySpeedReducerTypeEnum;  
END\_ENTITY;

**Attribute definitions:**

PreDefinedType: Predefined types of IfcRailwaySpeedReducer.

### 13.3.9 IfcRailwayRetarder

IfcRailwaySpeedRetarder defines the facility placed in the classification yard or the retarder zone to control the speed of the train.

**EXPRESS Specification:**

ENTITY IfcRailwayRetarder  
SUBTYPE OF (IfcRailwaySpeedControlDevice);  
PredefinedType: IfcRailwayRetarderTypeEnum;  
END\_ENTITY;

**Attribute definitions:**

PreDefinedType: Predefined types of IfcRailwayRetarder.

### 13.3.10 IfcRailwayDenoterDevice

IfcRailwayDenoterDevice defines the facility placed in station yards or near railway lines to show some useful information.

**Table 13.11 IfcRailwayDenoterDevice spatial contained in spatial structure**

Spatial Structure	Description
IfcRailwayStation	IfcRailwayDenoterDevice is contained in railway station.
IfcRailway	Directly contained in railway, if the signal device has no station

	information.
--	--------------

**EXPRESS Specification:**

ENTITY IfcRailwayDenoterDevice  
 SUBTYPE OF (IfcRailwayElement);  
 PredefinedType: IfcRailwayDenoterTypeEnum;  
 Note: IfcText;  
 END\_ENTITY;

**Attribute definitions:**

PreDefinedType: Predefined types of IfcRailwayDenoterDevice.  
 Note: Text showed on the denoter device.

**13.3.11 IfcRailwaySafetyDevice**

IfcRailwaySafetyDevice defines the facility which ensures the safety of train operation in the station.

**Table 13.12 IfcRailwayDenoterDevice contained in spatial structure**

Spatial Structure	Description
IfcRailwayStation	IfcRailwaySafetyDevice is contained in the railway station.

**EXPRESS Specification:**

ENTITY IfcRailwaySafetyDevice  
 SUPERTYPE OF (ONEOF (IfcRailwayCarBumper, IfcRailwayCarStopper, IfcRailwayIronShoeRemoving, IfcRailwayStopDevice, IfcRailwayStopRetarder, IfcRailwayIronShoe))  
 SUBTYPE OF (IfcRailwayElement);  
 END\_ENTITY;

**13.3.12 IfcRailwayCarBumper**

IfcRailwayCarBumper defines the facility placed at the end of the railway line to prevent the train from running off the rails.

**EXPRESS Specification:**

ENTITY IfcRailwayCarBumper  
 SUBTYPE OF (IfcRailwaySafetyDevice);  
 PredefinedType: IfcRailwayCarBumperTypeEnum;  
 END\_ENTITY;

**Attribute definitions:**

PreDefinedType: Predefined types of IfcRailwayCarBumper.

**13.3.13 IfcRailwayCarStopper**

IfcRailwayCarStopper defines the facility placed in front of the railway car bumper to prevent the train from running off the rails.

**EXPRESS Specification:**

ENTITY IfcRailwayCarStopper  
 SUBTYPE OF (IfcRailwaySafetyDevice);  
 PredefinedType: IfcRailwayCarStopperTypeEnum;

PositionType: IfcRailwayCarStopperPosTypeEnum;  
END\_ENTITY;

**Attribute definitions:**

PreDefinedType: Predefined types of IfcRailwayCarStopper.

PositionType: Position types of IfcRailwayCarStopper.

#### 13.3.14 IfcRailwayIronShoe

IfcRailwayIronShoe defines a kind of safety facility to ensure the train to stop at the proper position.

**EXPRESS Specification:**

ENTITY IfcRailwayIronShoe  
SUBTYPE OF (IfcRailwaySafetyDevice);  
PredefinedType: IfcRailwayIronShoeTypeEnum;  
END\_ENTITY;

**Attribute definitions:**

PreDefinedType: Predefined types of IfcRailwayIronShoe.

#### 13.3.15 IfcRailwayStopRetarde

IfcRailwayStopRetarder defines a kind of safety facility to ensure the train to stop at the proper position.

**EXPRESS Specification:**

ENTITY IfcRailwayStopRetarder  
SUBTYPE OF (IfcRailwaySafetyDevice);  
PredefinedType: IfcRailwayStopRetarderTypeEnum;  
END\_ENTITY;

**Attribute definitions:**

PreDefinedType: Predefined types of IfcRailwayStopRetarder.

#### 13.3.16 IfcRailwayStopDevice

IfcRailwayStopRetarder defines a kind of safety facility to ensure the train to stop at the proper position.

**EXPRESS Specification:**

ENTITY IfcRailwayStopDevice  
SUBTYPE OF (IfcRailwaySafetyDevice);  
PredefinedType: IfcRailwayStopDeviceTypeEnum;  
END\_ENTITY;

**Attribute definitions:**

PreDefinedType: Predefined types of IfcRailwayStopDevice.

#### 13.3.17 IfcRailwayIronShoeRemoving

IfcRailwayIronShoeRemoving defines a kind of safety facility to ensure the iron shoe to fall off from rails at the proper position.

**EXPRESS Specification:**

ENTITY IfcRailwayIronShoeRemoving  
 SUBTYPE OF (IfcRailwaySafetyDevice);  
 PredefinedType: IfcRailwayIronShoeRemovingTypeEnum;  
 END\_ENTITY;

**Attribute definitions:**

PreDefinedType: Predefined types of IfcRailwayIronShoeRemoving.

**13.3.18 IfcRailwayPlatformWall**

IfcRailwayPlatformWall defines the facility which holds the earthwork in the platform.

**Table 13.13 IfcRailwayPlatformWall contained in spatial structure**

Spatial Structure	Description
IfcRailwayPlatform	IfcRailwayPlatformWall is contained in station platform

**EXPRESS Specification:**

ENTITY IfcRailwayPlatformWall  
 SUBTYPE OF (IfcRailwayElement);  
 PredefinedType: IfcRailwayPlatformWallTypeEnum;  
 END\_ENTITY;

**Attribute definitions:**

PreDefinedType: Predefined types of IfcRailwayPlatformWall.

**13.3.19 IfcRailwayFlatAisle**

IfcRailwayFlatAisle defines the facility placed for people or vehicle to cross the railway track.

**Table 13.14 IfcRailwayFlatAisle contained in spatial structure**

Spatial Structure	Description
IfcRailwayStation	IfcRailwayFlatAisle is contained in the railway station.

**Table 13.15 Property sets for IfcRailwayFlatAisle**

PredefinedType	Name
	Pset_FlatAisleCommon

**EXPRESS Specification:**

ENTITY IfcRailwayFlatAisle  
 SUBTYPE OF (IfcRailwayElement);  
 PredefinedType: IfcRailwayFlatAisleTypeEnum;  
 END\_ENTITY;

**Attribute definitions:**

PreDefinedType: Predefined types of IfcRailwayFlatAisle.

**13.3.20 IfcRailwayMechanicalEquipment**

IfcRailwayMechanicalEquipment defines the mechanical facilities which are used in freight transportation operation. It currently has three subtypes, while more kinds of facilities will be added

as needed in the future.

**Table 13.16 IfcRailwayMechanicalEquipment contained in spatial structure**

<b>Spatial Structure</b>	<b>Description</b>
IfcRailwayStation	IfcRailwayMechanicalEquipment is contained in the railway station.

**EXPRESS Specification:**

ENTITY IfcRailwayMechanicalEquipment

SUPERTYPE OF (ONEOF

(IfcRailwayWagonScale, IfcRailwayTruckScale, IfcRailwayDeflectionInstrument))

SUBTYPE OF (IfcRailwayElement);

END\_ENTITY;

**13.3.21 IfcRailwayWagonScale**

IfcRailwayWagonScale defines the facility placed under the rails to measure the vehicle's load.

**EXPRESS Specification:**

ENTITY IfcRailwayWagonScale

SUBTYPE OF (IfcRailwayMechanicalEquipment);

PredefinedType: IfcRailwayWagonScaleTypeEnum;

END\_ENTITY;

**Attribute definitions:**

PreDefinedType: Predefined types of IfcRailwayWagonScale.

**13.3.22 IfcRailwayTruckScale**

IfcRailwayWagonScale defines the facility placed under the road to measure the truck's load in the railway station.

**EXPRESS Specification:**

ENTITY IfcRailwayTruckScale

SUBTYPE OF (IfcRailwayMechanicalEquipment);

PredefinedType: IfcRailwayTruckScaleTypeEnum;

END\_ENTITY;

**Attribute definitions:**

PreDefinedType: Predefined types of IfcRailwayTruckScale.

**13.3.23 IfcRailwayDeflectionInstrument**

IfcRailwayDeflectionInstrument defines the facility placed under the rails to analyze whether the train is partially loaded or overloaded in the railway station.

**EXPRESS Specification:**

ENTITY IfcRailwayDeflectionInstrument

SUBTYPE OF (IfcRailwayMechanicalEquipment);

PredefinedType: IfcRailwayDeflectionInstrumentTypeEnum;

END\_ENTITY;

**Attribute definitions:**

PreDefinedType: Predefined types of IfcRailwayDeflectionInstrument.

**13.4 Property Set Definition****13.4.1 Pset\_StationCommon**

Name: Pset\_StationCommon

Applicable Entities: IfcRailwayStation

Description: General property set for IfcRailwayStation.

Property Definitions: See Table 13.17.

**Table 13.17 Property definitions of Pset\_StationCommon**

<b>Name</b>	<b>Type</b>	<b>Description</b>
StationHousePos	TypePropertySingleValue/IfcLabel	Position of the station house. The position of the station house is on the left or right side along the forward direction of railway lines.
EffectiveLength	TypePropertySingleValue/IfcNonNegativeLengthMeasure/m	Effective length of the track.
CentralPoint	TypePropertySingleValue/IfcLabel	Center mileage of the station.
DividingPoint	TypePropertySingleValue/IfcLabel	Divided mileage of the station.

**13.4.2 Pset\_FlatAisleCommon**

Name: Pset\_FlatAisleCommon

Applicable Entities: IfcRailwayFlatAisle

Description: General property set for IfcRailwayFlatAisle.

Property Definitions: See Table 13.18.

**Table 13.18 Property definitions of IfcRailwayFlatAisle**

<b>Name</b>	<b>Type</b>	<b>Description</b>
Spacing	TypePropertySingleValue/IfcPositiveLengthMeasure/m	Track spacing. The sum of railway track spacing crossed by the flat aisle.
CrossLineNumber	TypePropertySingleValue/IfcInteger	Track number. The number of railway tracks crossed by the flat aisle.
HasGuard	TypePropertySingleValue/IfcBoolean	Whether there is guard near the flat aisle.

**13.4.3 Pset\_SignalCommon**

Name: Pset\_SignalCommon

Applicable Entities: IfcRailwaySignal

Description: General property set for IfcRailwaySignal.

Property Definitions: See Table 13.29.



**Table 13.19 Property definitions of IfcRailwaySignal**

<b>Name</b>	<b>Type</b>	<b>Description</b>
IsHighPole	TypePropertySingleValue/IfcBoolean	Whether the signal has a high pole.
NumberOfInstitutions	TypePropertySingleValue/IfcInteger	The number of the signal's Institutions.
HasExpress	TypePropertySingleValue/IfcBoolean	Whether the signal has express indicator.

## **14. Others**

### **14. 1 Cable Slot**

IfcDistributionSystem is used to represent the railway cable slot. The predefined type "CONVEYING" or "USERDEFINED" should be selected from the IfcDistributionSystemEnum.

IfcCableCarrierSegment is used to represent railway cable slot segment. The predefined type "CABLETRUNKINGSEGMENT" should be selected from the IfcCableCarrierSegmentTypeEnum.

IfcDistributionChamberElement is used to represent the inspection well on the cable slot. The predefined type "MANHOLE" should be selected from the IfcDistributionChamberElementTypeEnum.